

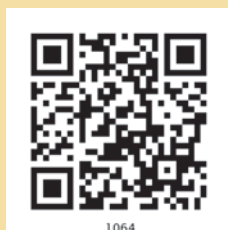

SCIENCE

TEXTBOOK FOR CLASS X

© NCERT
not to be republished



विद्यया ऽ मृतमश्नुते



एन सी ई आर टी
NCERT

राष्ट्रीय शैक्षिक अनुसंधान और प्रशिक्षण परिषद्
NATIONAL COUNCIL OF EDUCATIONAL RESEARCH AND TRAINING

ISBN 81-7450-636-5

First Edition

December 2006 *Agrahayana 1928*

Reprinted

November 2007 *Kartika 1929*
January 2009 *Pausa 1930*
December 2009 *Pausa 1931*
November 2010 *Kartika 1932*
January 2012 *Magha 1933*
November 2012 *Kartika 1934*
October 2013 *Asvina 1935*
December 2014 *Pausa 1936*
December 2015 *Agrahayana 1937*
February 2017 *Magha 1938*
January 2018 *Pausa 1939*
January 2019 *Pausa 1940*

PD 700T BS

© **National Council of Educational
Research and Training, 2006**

₹ ??.00

*Printed on 80 GSM paper with NCERT
watermark*

Published at the Publication Division by the
Secretary, National Council of Educational
Research and Training, Sri Aurobindo Marg,
New Delhi 110 016 and printed at
Educational Stores, S-5, Bulandshahar
Road, Industrial Area Site-I (Near RTO
Office) Ghaziabad (U.P.)

ALL RIGHTS RESERVED

- No part of this publication may be reproduced, stored in a retrieval system or transmitted, in any form or by any means, electronic, mechanical, photocopying, recording or otherwise without the prior permission of the publisher.
- This book is sold subject to the condition that it shall not, by way of trade, be lent, re-sold, hired out or otherwise disposed of without the publisher's consent, in any form of binding or cover other than that in which it is published.
- The correct price of this publication is the price printed on this page. Any revised price indicated by a rubber stamp or by a sticker or by any other means is incorrect and should be unacceptable.

OFFICES OF THE PUBLICATION

DIVISION, NCERT

NCERT Campus
Sri Aurobindo Marg
New Delhi 110 016 Phone : 011-26562708

108, 100 Feet Road
Hosdakere Halli Extension
Banashankari III Stage
Bengaluru 560 085 Phone : 080-26725740

Navjivan Trust Building
P.O. Navjivan
Ahmedabad 380 014 Phone : 079-27541446

CWC Campus
Opp. Dhankal Bus Stop
Panihati
Kolkata 700 114 Phone : 033-25530454

CWC Complex
Maligaon
Guwahati 781 021 Phone : 0361-2674869

Publication Team

Head, Publication Division : *M. Siraj Anwar*

Chief Editor : *Shweta Uppal*

Chief Business Manager : *Gautam Ganguly*

Chief Production Officer : *Arun Chitkara*

Production Assistant : *Om Prakash*

Cover, Layout and Illustrations

Digital Expressions

F O R E W O R D

The National Curriculum Framework, (NCF), 2005, recommends that children's life at school must be linked to their life outside the school. This principle marks a departure from the legacy of bookish learning which continues to shape our system and causes a gap between the school, home and community. The syllabi and textbooks developed on the basis of NCF signify an attempt to implement this basic idea. They also attempt to discourage rote learning and the maintenance of sharp boundaries between different subject areas. We hope these measures will take us significantly further in the direction of a child-centred system of education outlined in the National Policy on Education (1986).

The success of this effort depends on the steps that school principals and teachers will take to encourage children to reflect on their own learning and to pursue imaginative activities and questions. We must recognise that, given space, time and freedom, children generate new knowledge by engaging with the information passed on to them by adults. Treating the prescribed textbook as the sole basis of examination is one of the key reasons why other resources and sites of learning are ignored. Inculcating creativity and initiative is possible if we perceive and treat children as participants in learning, not as receivers of a fixed body of knowledge.

These aims imply considerable change in school routines and mode of functioning. Flexibility in the daily time-table is as necessary as rigour in implementing the annual calendar so that the required number of teaching days are actually devoted to teaching. The methods used for teaching and evaluation will also determine how effective this textbook proves for making children's life at school a happy experience, rather than a source of stress or boredom. Syllabus designers have tried to address the problem of curricular burden by restructuring and reorienting knowledge at different stages with greater consideration for child psychology and the time available for teaching. The textbook attempts to enhance this endeavour by giving higher priority and space to opportunities for contemplation and wondering, discussion in small groups, and activities requiring hands-on experience.

The National Council of Educational Research and Training (NCERT) appreciates the hard work done by the textbook development team responsible for this book. We wish to thank the Chairman of the advisory group in science and mathematics, Professor J.V. Narlikar and the Chief Advisor for this book, Professor Rupamanjari Ghosh, School of Physical Sciences, Jawaharlal Nehru University, New Delhi, for guiding the work of this committee. Several teachers contributed to the development of this textbook; we are grateful to them and their principals for making this possible. We are indebted to the institutions and organisations which have generously permitted us to draw upon their resources, material and personnel. We are especially grateful to the members of

the National Monitoring Committee, appointed by the Department of Secondary and Higher Education, Ministry of Human Resource Development under the Chairmanship of Professor Mrinal Miri and Professor G.P. Deshpande, for their valuable time and contribution. As an organisation committed to systemic reform and continuous improvement in the quality of its products, NCERT welcomes comments and suggestions which will enable us to undertake further revision and refinement.

New Delhi
20 November 2006

Director
National Council of Educational
Research and Training

© NCERT
not to be republished

P R E F A C E

This textbook of Science for Class X is a continuation of our attempt in the Class IX Science textbook to comply with the guidelines of the National Curriculum Framework-2005. We had to work within a limited time frame and also had our own constraints coming in the way of this radical change. The revised and re-structured syllabus for Class X covers selected topics in the broad themes of — Materials, The World of the Living, How Things Work, Natural Phenomena and Natural Resources. We have interpreted the syllabus to present a coherent coverage of scientific concepts related to our daily life on the select topics. It is an integrated approach to science at this level, with no sharp divisions into disciplines such as Physics, Chemistry, Biology and Environmental Science.

There has been a conscious attempt to address the relevant social concerns in this science textbook wherever possible — the concerns for people with special needs, the issues of gender discrimination, energy and environment have found their natural place in this book. Students have been encouraged to get into the debates on some of the management concerns (for sustainable development, for example) so that they can arrive at their own decisions after a scientific analysis of all the facts.

This book has some features which are meant to enhance its effectiveness. The theme of each chapter has been introduced with examples from daily life, and if possible, by a relevant activity that the students have to perform. The entire approach of the book is, in fact, activity-based, i.e., the students are required to construct knowledge themselves from these activities. The emphasis is not on definitions and technical terms, but on the concepts involved. Special care has been taken so that the rigour of science is not lost while simplifying the language. Difficult and challenging ideas, which are not to be covered at this stage, have often been placed as extra material in the boxes in light orange. The excitement of doing science comes from pursuing the unknown — the students would have the opportunity to think and explore somewhat beyond the syllabus and may feel the urge to continue their scientific expedition at higher levels. All such box items, including brief biography of scientists, are, of course, non-evaluative.

Solved examples are provided, wherever felt necessary, to clarify a concept. The in-text questions after a main section are for the students to check their understanding of the topic. At the end of each chapter, there is a quick review of the important points covered in the chapter. We have introduced some multiple choice questions in the exercises. There are problems of different difficulty levels answers to the multiple-choice questions and numericals, and hints for the difficult questions are included at the end of the book.

This book has been made possible because of the active participation of many people. I wish to thank Professor Krishna Kumar, *Director*, NCERT, Prof. G. Ravindra, *Joint Director*, NCERT, and Professor Hukum Singh, Head, Department of Education in Science and Mathematics, NCERT, specially for their keen interest in the development of the book and for all the administrative support. I wish to put on record my sincere appreciation for Dr Anjni Koul, the member-coordinator of the textbook development committee, for her extraordinary commitment and efficiency. It has been a real pleasure working with my textbook development team and the review committee. The chosen editorial team worked extremely hard, on tight deadlines, to bring the book close to the shape that we dreamt of. Fruitful discussions with some members of the MHRD Monitoring Committee helped in providing the final touches to the book. I do not have the words to acknowledge the professional and personal inputs I received from some of my close friends during the preparation of this book. We warmly welcome comments and suggestions for improvement from our readers.

RUPAMANJARI GHOSH
Professor of Physics
School of Physical Sciences
Jawaharlal Nehru University
New Delhi

TEXTBOOK DEVELOPMENT COMMITTEE

CHAIRMAN, ADVISORY GROUP FOR TEXTBOOKS IN SCIENCE AND MATHEMATICS

J.V. Narlikar, *Emeritus Professor*, Inter-University Centre for Astronomy and Astrophysics (IUCAA), Ganeshkhind, Pune University, Pune

CHIEF ADVISOR

Rupamanjari Ghosh, *Professor*, School of Physical Sciences, Jawaharlal Nehru University, New Delhi

MEMBERS

Alka Mehrotra, *Reader*, DESM, NCERT, New Delhi

Animesh K. Mohapatra, *Reader*, Regional Institute of Education, Ajmer

B.B. Swain, *Professor (Retd.)*, Department of Physics, Utkal University, Orissa

B.K. Sharma, *Professor*, DESM, NCERT, New Delhi

B.K. Tripathi, *Reader*, DESM, NCERT, New Delhi

Brahm Parkash, *Professor*, DESM, NCERT, New Delhi

Charu Maini, *PGT*, Salwan Public School, Gurgaon, Haryana

Dinesh Kumar, *Reader*, DESM, NCERT, New Delhi

Gagan Gupta, *Reader*, DESM, NCERT, New Delhi

H.L. Satheesh, *TGT*, DM School, Regional Institute of Education, Mysore

Ishwant Kaur, *PGT*, DM School, Regional Institute of Education, Bhopal

J.D. Arora, *Reader*, Hindu College, Moradabad, Uttar Pradesh

Meenambika Menon, *TGT*, Cambridge School, Noida, Uttar Pradesh

Puran Chand, *Professor and Jt. Director (Retd.)*, Central Institute of Educational Technology
NCERT, New Delhi

Reeta Sharma, *Reader*, Regional Institute of Education, Bhopal

R.P. Singh, *Lecturer*, Rajkiya Pratibha Vikas Vidyalaya, Kishan Ganj, Delhi

Satyajit Rath, *Scientist*, National Institute of Immunology, JNU Campus, New Delhi

S.K. Dash, *Reader*, Regional Institute of Education, Bhubaneswar

Sunita Ramrakhiani, *PGT*, Ahlcon Public School, Delhi

Uma Sudhir, *Eklavya*, Indore, Madhya Pradesh

Vandana Saxena, *TGT*, Kendriya Vidyalaya-4, Kandhar Lines, Delhi Cantt., New Delhi

Vinod Kumar, *Reader*, Hans Raj College, Delhi University, Delhi

MEMBER-COORDINATOR

Anjni Koul, *Lecturer*, DESM, NCERT, New Delhi

ACKNOWLEDGEMENTS

The National Council of Educational Research and Training (NCERT), besides expressing its gratefulness towards the members of the Textbook Development Committee for their contribution in the development of the Science Textbook for Class X, also acknowledges the contribution of the following members for reviewing, editing, refining, and finalisation of the manuscript of the book. Kanhiya Lal, *Principal* (Retd.), Directorate of Education, NCT, Delhi; Ranveer Singh, *Lecturer*, Sarvodaya Bal Vidyalaya, Timarpur, Delhi; Bharat Poorey, *Professor* (Retd.), Govt. Post Graduate College, Indore; Gagandeep Bajaj, *Lecturer*, S.P.M. College, Delhi University, Delhi; Ravinder Kaur, *TGT*, Kendriya Vidyalaya, Rohini, Delhi; Renu Puri, *TGT*, N.C. Jindal Public School, New Delhi; Sarita Kumar, *Reader*, Acharya Narendra Dev College, Delhi University, Delhi; Shashi Prabha, *Lecturer*, DESM, NCERT, Delhi; Rashmi Sharma, *Lecturer*, NERIE, Shillong; Sushma Jaireth, *Reader*, DWS, NCERT, New Delhi; Y.P. Purang, Addl. Director of Education (Retd.), NCT, Delhi; Neeta Agarwal, *TGT*, D.L.D.A.V. Model School, Pitampura, Delhi; Roma Anand, *TGT*, D.L.D.A.V., Pitampura, Delhi; Veer Pal Singh, *Reader*, DEME, NCERT, New Delhi and S.L. Varte, *Lecturer*, DESM, NCERT, New Delhi.

The Council also acknowledges the valuable contribution of Sunita Farkya (*Professor*, DESM), Pushplata Verma (*Assistant Professor*, DESM), K.C. Tripathi (*Professor*, DEL) and Jatindra Mohan Misra (*Professor*, DEL) in updating Chapter 16 titled "Sustainable Management of Natural Resources", and also in the review of this textbook.

The contribution of R.S. Sindhu, *Professor* (Retd.), DESM; V.P. Srivastava, *Professor* (Retd.), DESM; R.K. Parashar, Rachna Garg (*Professors*, DESM); V.V. Anand, *Professor* (Retd.), RIE Mysore; S.V. Sharma (*Professor*, RIE Mysore); V.P. Singh (*Professor*, RIE Ajmer); R. Joshi, *Associate Professor* (Retd.), DESM; C.V. Shimray, Ruchi Verma (*Associate Professors*, DESM); Ram Babu Pareek (*Associate Professor*, RIE Ajmer); A.K. Srivastava, Rejaul Karim Barbhuiya, Pramila Tanwar (*Assistant Professors*, DESM); R.R. Koireng (*Assistant Professor*, DCS); V. Tangpu (*Assistant Professor*, RIE Mysore) and Akhileshwar Mishra (*Head Master*, DMS, RIE Bhubaneswar), in the review of this textbook in 2017-18 are acknowledged.

Special thanks are due to Hukum Singh, *Professor* and Former *Head*, DESM, NCERT, New Delhi, for providing all academic and administrative support.

The Council also gratefully acknowledges the support provided by the APC Office of DESM, administrative staff of DESM; Deepak Kapoor, *Incharge*, Computer Station, DESM; Saima and Arvind Sharma, *DTP Operators* and Rajesh Handa, *Illustrator*; Mohd. Qamar Tabrez and Musarrat Parveen, *Copy Editors*; Seema Yadav, *Proof Reader*. The efforts of the Publication Department, NCERT are also highly appreciated.

CONTENTS

<i>Foreword</i>		<i>iii</i>
<i>Preface</i>		<i>v</i>
Chapter 1	Chemical Reactions and Equations	1
Chapter 2	Acids, Bases and Salts	17
Chapter 3	Metals and Non-metals	37
Chapter 4	Carbon and its Compounds	58
Chapter 5	Periodic Classification of Elements	79
Chapter 6	Life Processes	93
Chapter 7	Control and Coordination	114
Chapter 8	How do Organisms Reproduce?	127
Chapter 9	Heredity and Evolution	142
Chapter 10	Light – Reflection and Refraction	160
Chapter 11	The Human Eye and the Colourful World	187
Chapter 12	Electricity	199
Chapter 13	Magnetic Effects of Electric Current	223
Chapter 14	Sources of Energy	242
Chapter 15	Our Environment	256
Chapter 16	Sustainable Management of Natural Resources	266
	Answers	281-282

CONTENTS

THE CONSTITUTION OF INDIA

PREAMBLE

WE, THE PEOPLE OF INDIA, having solemnly resolved to constitute India into a ¹**[SOVEREIGN SOCIALIST SECULAR DEMOCRATIC REPUBLIC]** and to secure to all its citizens :

JUSTICE, social, economic and political;

LIBERTY of thought, expression, belief, faith and worship;

EQUALITY of status and of opportunity; and to promote among them all

FRATERNITY assuring the dignity of the individual and the ²[unity and integrity of the Nation];

IN OUR CONSTITUENT ASSEMBLY this twenty-sixth day of November, 1949 do **HEREBY ADOPT, ENACT AND GIVE TO OURSELVES THIS CONSTITUTION.**

1. Subs. by the Constitution (Forty-second Amendment) Act, 1976, Sec.2, for "Sovereign Democratic Republic" (w.e.f. 3.1.1977)
2. Subs. by the Constitution (Forty-second Amendment) Act, 1976, Sec.2, for "Unity of the Nation" (w.e.f. 3.1.1977)

“Facts are not science — as the dictionary is not literature.”
Martin H. Fischer

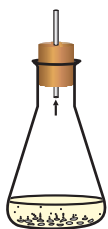

CHAPTER 1

Chemical Reactions and Equations



1064CH01

Consider the following situations of daily life and think what happens when –

- milk is left at room temperature during summers.
- an iron tawa/pan/nail is left exposed to humid atmosphere.
- grapes get fermented.
- food is cooked.
- food gets digested in our body.
- we respire.

In all the above situations, the nature and the identity of the initial substance have somewhat changed. We have already learnt about physical and chemical changes of matter in our previous classes. Whenever a chemical change occurs, we can say that a chemical reaction has taken place.

You may perhaps be wondering as to what is actually meant by a chemical reaction. How do we come to know that a chemical reaction has taken place? Let us perform some activities to find the answer to these questions.

Activity 1.1

CAUTION: This Activity needs the teacher’s assistance. It would be better if students wear suitable eyeglasses.

- Clean a magnesium ribbon about 3-4 cm long by rubbing it with sandpaper.
- Hold it with a pair of tongs. Burn it using a spirit lamp or burner and collect the ash so formed in a watch-glass as shown in Fig. 1.1. Burn the magnesium ribbon keeping it away as far as possible from your eyes.
- What do you observe?

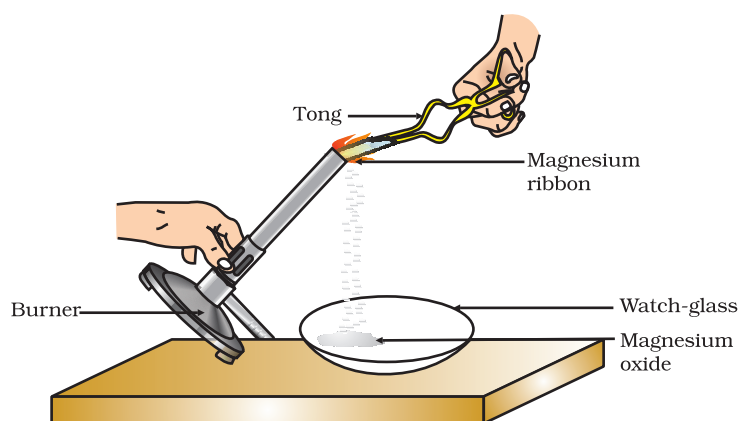

Figure 1.1

Burning of a magnesium ribbon in air and collection of magnesium oxide in a watch-glass

You must have observed that magnesium ribbon burns with a dazzling white flame and changes into a white powder. This powder is magnesium oxide. It is formed due to the reaction between magnesium and oxygen present in the air.

Activity 1.2

- Take lead nitrate solution in a test tube.
- Add potassium iodide solution to this.
- What do you observe?

Activity 1.3

- Take a few zinc granules in a conical flask or a test tube.
- Add dilute hydrochloric acid or sulphuric acid to this (Fig. 1.2).
- CAUTION:** Handle the acid with care.
- Do you observe anything happening around the zinc granules?
- Touch the conical flask or test tube. Is there any change in its temperature?

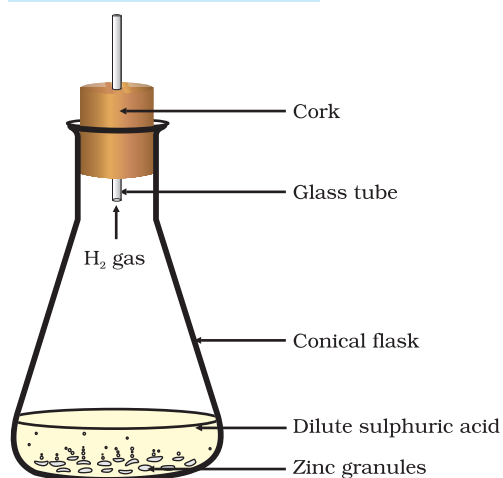

Figure 1.2
Formation of hydrogen gas by the action of dilute sulphuric acid on zinc

From the above three activities, we can say that any of the following observations helps us to determine whether a chemical reaction has taken place –

- change in state
- change in colour
- evolution of a gas
- change in temperature.

As we observe the changes around us, we can see that there is a large variety of chemical reactions taking place around us. We will study about the various types of chemical reactions and their symbolic representation in this Chapter.

1.1 CHEMICAL EQUATIONS

Activity 1.1 can be described as – when a magnesium ribbon is burnt in oxygen, it gets converted to magnesium oxide. This description of a chemical reaction in a sentence form is quite long. It can be written in a shorter form. The simplest way to do this is to write it in the form of a word-equation.

The word-equation for the above reaction would be –



The substances that undergo chemical change in the reaction (1.1), magnesium and oxygen, are the reactants. The new substance is magnesium oxide, formed during the reaction, as a product.

A word-equation shows change of reactants to products through an arrow placed between them. The reactants are written on the left-hand side (LHS) with a plus sign (+) between them. Similarly, products are written on the right-hand side (RHS) with a plus sign (+) between them. The arrowhead points towards the products, and shows the direction of the reaction.

1.1.1 Writing a Chemical Equation

Is there any other shorter way for representing chemical equations? Chemical equations can be made more concise and useful if we use chemical formulae instead of words. A chemical equation represents a chemical reaction. If you recall formulae of magnesium, oxygen and magnesium oxide, the above word-equation can be written as –



Count and compare the number of atoms of each element on the LHS and RHS of the arrow. Is the number of atoms of each element the same on both the sides? If yes, then the equation is balanced. If not, then the equation is unbalanced because the mass is not the same on both sides of the equation. Such a chemical equation is a skeletal chemical equation for a reaction. Equation (1.2) is a skeletal chemical equation for the burning of magnesium in air.

1.1.2 Balanced Chemical Equations

Recall the law of conservation of mass that you studied in Class IX; mass can neither be created nor destroyed in a chemical reaction. That is, the total mass of the elements present in the products of a chemical reaction has to be equal to the total mass of the elements present in the reactants.

In other words, the number of atoms of each element remains the same, before and after a chemical reaction. Hence, we need to balance a skeletal chemical equation. Is the chemical Eq. (1.2) balanced? Let us learn about balancing a chemical equation step by step.

The word-equation for Activity 1.3 may be represented as –



The above word-equation may be represented by the following chemical equation –



Let us examine the number of atoms of different elements on both sides of the arrow.

Element	Number of atoms in reactants (LHS)	Number of atoms in products (RHS)
Zn	1	1
H	2	2
S	1	1
O	4	4

As the number of atoms of each element is the same on both sides of the arrow, Eq. (1.3) is a balanced chemical equation.

Let us try to balance the following chemical equation –

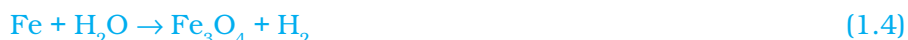

Step I: To balance a chemical equation, first draw boxes around each formula. Do not change anything inside the boxes while balancing the equation.



Step II: List the number of atoms of different elements present in the unbalanced equation (1.5).

Element	Number of atoms in reactants (LHS)	Number of atoms in products (RHS)
Fe	1	3
H	2	2
O	1	4

Step III: It is often convenient to start balancing with the compound that contains the maximum number of atoms. It may be a reactant or a product. In that compound, select the element which has the maximum number of atoms. Using these criteria, we select Fe_3O_4 and the element oxygen in it. There are four oxygen atoms on the RHS and only one on the LHS.

To balance the oxygen atoms –

Atoms of oxygen	In reactants	In products
(i) Initial	1 (in H_2O)	4 (in Fe_3O_4)
(ii) To balance	1×4	4

To equalise the number of atoms, it must be remembered that we cannot alter the formulae of the compounds or elements involved in the reactions. For example, to balance oxygen atoms we can put coefficient '4' as $4 \text{H}_2\text{O}$ and not H_2O_4 or $(\text{H}_2\text{O})_4$. Now the partly balanced equation becomes –



Step IV: Fe and H atoms are still not balanced. Pick any of these elements to proceed further. Let us balance hydrogen atoms in the partly balanced equation.

To equalise the number of H atoms, make the number of molecules of hydrogen as four on the RHS.

Atoms of hydrogen	In reactants	In products
(i) Initial	8 (in $4 \text{H}_2\text{O}$)	2 (in H_2)
(ii) To balance	8	2×4

The equation would be –



Step V: Examine the above equation and pick up the third element which is not balanced. You find that only one element is left to be balanced, that is, iron.

Atoms of iron	In reactants	In products
(i) Initial	1 (in Fe)	3 (in Fe ₃ O ₄)
(ii) To balance	1×3	3

To equalise Fe, we take three atoms of Fe on the LHS.



Step VI: Finally, to check the correctness of the balanced equation, we count atoms of each element on both sides of the equation.



The numbers of atoms of elements on both sides of Eq. (1.9) are equal. This equation is now balanced. This method of balancing chemical equations is called hit-and-trial method as we make trials to balance the equation by using the smallest whole number coefficient.

Step VII: Writing Symbols of Physical States Carefully examine the above balanced Eq. (1.9). Does this equation tell us anything about the physical state of each reactant and product? No information has been given in this equation about their physical states.

To make a chemical equation more informative, the physical states of the reactants and products are mentioned along with their chemical formulae. The gaseous, liquid, aqueous and solid states of reactants and products are represented by the notations (g), (l), (aq) and (s), respectively. The word aqueous (aq) is written if the reactant or product is present as a solution in water.

The balanced Eq. (1.9) becomes



Note that the symbol (g) is used with H₂O to indicate that in this reaction water is used in the form of steam.

Usually physical states are not included in a chemical equation unless it is necessary to specify them.

Sometimes the reaction conditions, such as temperature, pressure, catalyst, etc., for the reaction are indicated above and/or below the arrow in the equation. For example –

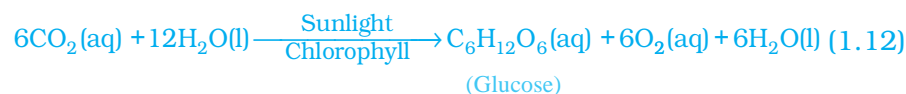

Using these steps, can you balance Eq. (1.2) given in the text earlier?

Q U E S T I O N S

1. Why should a magnesium ribbon be cleaned before burning in air?
2. Write the balanced equation for the following chemical reactions.
 - (i) Hydrogen + Chlorine → Hydrogen chloride
 - (ii) Barium chloride + Aluminium sulphate → Barium sulphate + Aluminium chloride
 - (iii) Sodium + Water → Sodium hydroxide + Hydrogen
3. Write a balanced chemical equation with state symbols for the following reactions.
 - (i) Solutions of barium chloride and sodium sulphate in water react to give insoluble barium sulphate and the solution of sodium chloride.
 - (ii) Sodium hydroxide solution (in water) reacts with hydrochloric acid solution (in water) to produce sodium chloride solution and water.



1.2 TYPES OF CHEMICAL REACTIONS

We have learnt in Class IX that during a chemical reaction atoms of one element do not change into those of another element. Nor do atoms disappear from the mixture or appear from elsewhere. Actually, chemical reactions involve the breaking and making of bonds between atoms to produce new substances. You will study about types of bonds formed between atoms in Chapters 3 and 4.

1.2.1 Combination Reaction

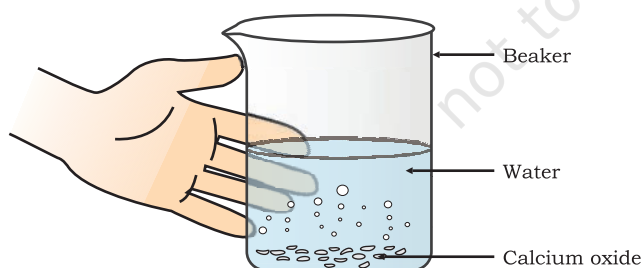
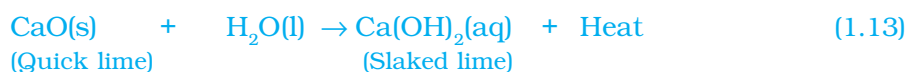

Figure 1.3
Formation of slaked lime by the reaction of calcium oxide with water

Activity 1.4

- Take a small amount of calcium oxide or quick lime in a beaker.
- Slowly add water to this.
- Touch the beaker as shown in Fig. 1.3.
- Do you feel any change in temperature?

Calcium oxide reacts vigorously with water to produce slaked lime (calcium hydroxide) releasing a large amount of heat.



In this reaction, calcium oxide and water combine to form a single product, calcium hydroxide. Such a reaction in which a single product is formed from two or more reactants is known as a combination reaction.

Do You Know?

A solution of slaked lime produced by the reaction 1.13 is used for whitewashing walls. Calcium hydroxide reacts slowly with the carbon dioxide in air to form a thin layer of calcium carbonate on the walls. Calcium carbonate is formed after two to three days of whitewashing and gives a shiny finish to the walls. It is interesting to note that the chemical formula for marble is also CaCO_3 .

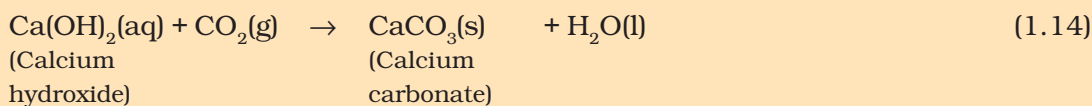

Let us discuss some more examples of combination reactions.

- (i) Burning of coal

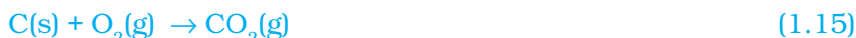

- (ii) Formation of water from $\text{H}_2(\text{g})$ and $\text{O}_2(\text{g})$



In simple language we can say that when two or more substances (elements or compounds) combine to form a single product, the reactions are called combination reactions.

In Activity 1.4, we also observed that a large amount of heat is evolved. This makes the reaction mixture warm. Reactions in which heat is released along with the formation of products are called exothermic chemical reactions.

Other examples of exothermic reactions are –

- (i) Burning of natural gas



- (ii) Do you know that respiration is an exothermic process?

We all know that we need energy to stay alive. We get this energy from the food we eat. During digestion, food is broken down into simpler substances. For example, rice, potatoes and bread contain carbohydrates. These carbohydrates are broken down to form glucose. This glucose combines with oxygen in the cells of our body and provides energy. The special name of this reaction is respiration, the process of which you will study in Chapter 6.

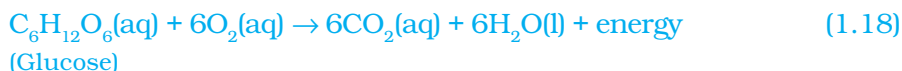

- (iii) The decomposition of vegetable matter into compost is also an example of an exothermic reaction.

Identify the type of the reaction taking place in Activity 1.1, where heat is given out along with the formation of a single product.

1.2.2 Decomposition Reaction

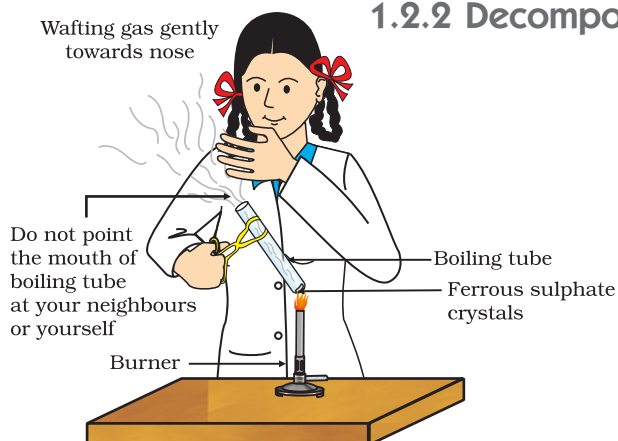
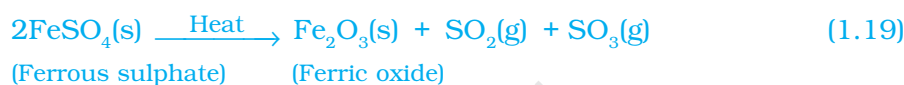

Figure 1.4
Correct way of heating the boiling tube containing crystals of ferrous sulphate and of smelling the odour

Have you noticed that the green colour of the ferrous sulphate crystals has changed? You can also smell the characteristic odour of burning sulphur.



In this reaction you can observe that a single reactant breaks down to give simpler products. This is a decomposition reaction. Ferrous sulphate crystals ($\text{FeSO}_4 \cdot 7\text{H}_2\text{O}$) lose water when heated and the colour of the crystals changes. It then decomposes to ferric oxide (Fe_2O_3), sulphur dioxide (SO_2) and sulphur trioxide (SO_3). Ferric oxide is a solid, while SO_2 and SO_3 are gases.

Decomposition of calcium carbonate to calcium oxide and carbon dioxide on heating is an important decomposition reaction used in various industries. Calcium oxide is called lime or quick lime. It has many uses – one is in the manufacture of cement. When a decomposition reaction is carried out by heating, it is called thermal decomposition.

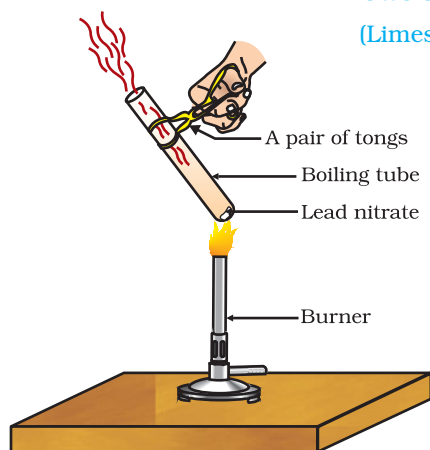
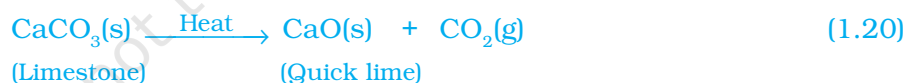

Figure 1.5
Heating of lead nitrate and emission of nitrogen dioxide

Activity 1.5

- Take about 2 g ferrous sulphate crystals in a dry boiling tube.
- Note the colour of the ferrous sulphate crystals.
- Heat the boiling tube over the flame of a burner or spirit lamp as shown in Fig. 1.4.
- Observe the colour of the crystals after heating.

Another example of a thermal decomposition reaction is given in Activity 1.6.

Activity 1.6

- Take about 2 g lead nitrate powder in a boiling tube.
- Hold the boiling tube with a pair of tongs and heat it over a flame, as shown in Fig. 1.5.
- What do you observe? Note down the change, if any.

You will observe the emission of brown fumes. These fumes are of nitrogen dioxide (NO_2). The reaction that takes place is –



Let us perform some more decomposition reactions as given in Activities 1.7 and 1.8.

Activity 1.7

- Take a plastic mug. Drill two holes at its base and fit rubber stoppers in these holes. Insert carbon electrodes in these rubber stoppers as shown in Fig. 1.6.
 - Connect these electrodes to a 6 volt battery.
 - Fill the mug with water such that the electrodes are immersed. Add a few drops of dilute sulphuric acid to the water.
 - Take two test tubes filled with water and invert them over the two carbon electrodes.
 - Switch on the current and leave the apparatus undisturbed for some time.
 - You will observe the formation of bubbles at both the electrodes. These bubbles displace water in the test tubes.
 - Is the volume of the gas collected the same in both the test tubes?
 - Once the test tubes are filled with the respective gases, remove them carefully.
 - Test these gases one by one by bringing a burning candle close to the mouth of the test tubes.
- CAUTION:** This step must be performed carefully by the teacher.
- What happens in each case?
 - Which gas is present in each test tube?

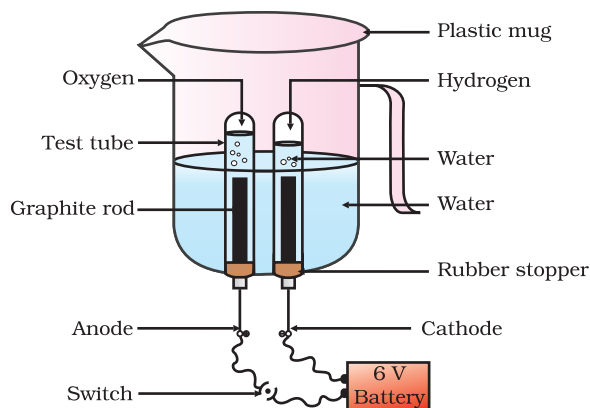

Figure 1.6
Electrolysis of water

Activity 1.8

- Take about 2 g silver chloride in a china dish.
- What is its colour?
- Place this china dish in sunlight for some time (Fig. 1.7).
- Observe the colour of the silver chloride after some time.

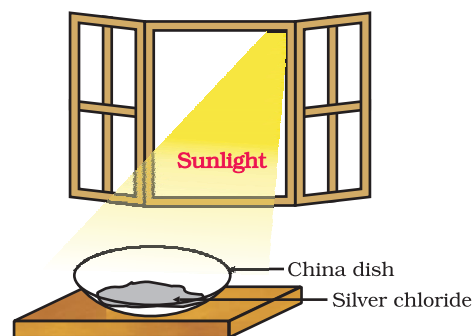

Figure 1.7
Silver chloride turns grey in sunlight to form silver metal

You will see that white silver chloride turns grey in sunlight. This is due to the decomposition of silver chloride into silver and chlorine by light.



Silver bromide also behaves in the same way.



The above reactions are used in black and white photography. What form of energy is causing these decomposition reactions?

We have seen that the decomposition reactions require energy either in the form of heat, light or electricity for breaking down the reactants. Reactions in which energy is absorbed are known as endothermic reactions.

Carry out the following Activity

Take about 2 g barium hydroxide in a test tube. Add 1 g of ammonium chloride and mix with the help of a glass rod. Touch the bottom of the test tube with your palm. What do you feel? Is this an exothermic or endothermic reaction?

Q U E S T I O N S

1. A solution of a substance 'X' is used for whitewashing.
 - (i) Name the substance 'X' and write its formula.
 - (ii) Write the reaction of the substance 'X' named in (i) above with water.
2. Why is the amount of gas collected in one of the test tubes in Activity 1.7 double of the amount collected in the other? Name this gas.



1.2.3 Displacement Reaction

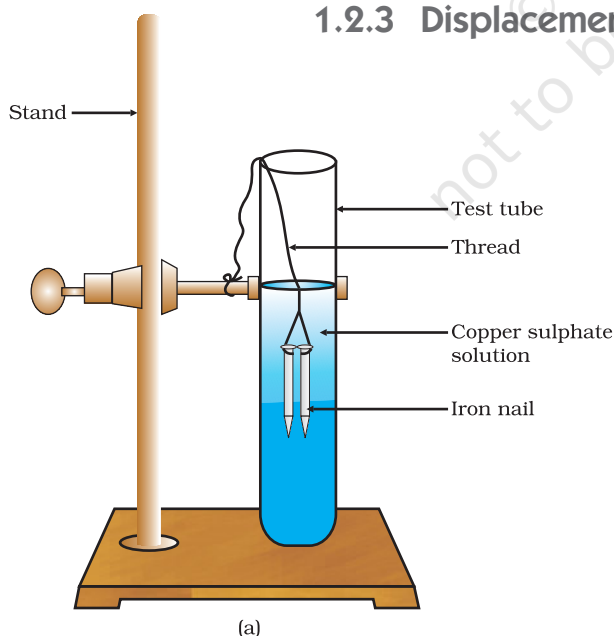

Figure 1.8
(a) Iron nails dipped in copper sulphate solution

Activity 1.9

- Take three iron nails and clean them by rubbing with sand paper.
- Take two test tubes marked as (A) and (B). In each test tube, take about 10 mL copper sulphate solution.
- Tie two iron nails with a thread and immerse them carefully in the copper sulphate solution in test tube B for about 20 minutes [Fig. 1.8 (a)]. Keep one iron nail aside for comparison.
- After 20 minutes, take out the iron nails from the copper sulphate solution.
- Compare the intensity of the blue colour of copper sulphate solutions in test tubes (A) and (B) [Fig. 1.8 (b)].
- Also, compare the colour of the iron nails dipped in the copper sulphate solution with the one kept aside [Fig. 1.8 (b)].

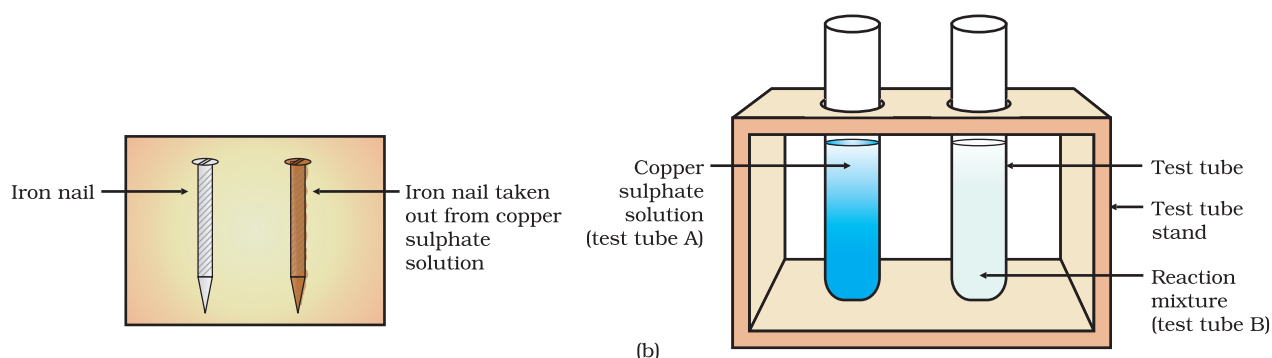
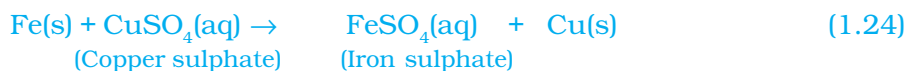

Figure 1.8 (b) Iron nails and copper sulphate solutions compared before and after the experiment

Why does the iron nail become brownish in colour and the blue colour of copper sulphate solution fades?

The following chemical reaction takes place in this Activity–



In this reaction, iron has displaced or removed another element, copper, from copper sulphate solution. This reaction is known as displacement reaction.

Other examples of displacement reactions are

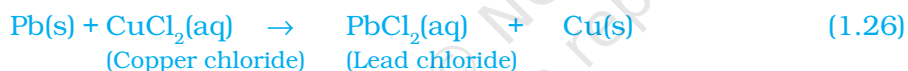
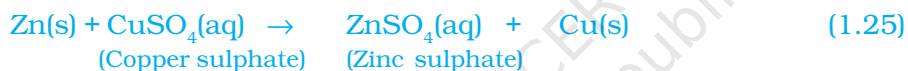

Zinc and lead are more reactive elements than copper. They displace copper from its compounds.

1.2.4 Double Displacement Reaction

Activity 1.10

- Take about 3 mL of sodium sulphate solution in a test tube.
- In another test tube, take about 3 mL of barium chloride solution.
- Mix the two solutions (Fig. 1.9).
- What do you observe?

You will observe that a white substance, which is insoluble in water, is formed. This insoluble substance formed is known as a precipitate. Any reaction that produces a precipitate can be called a precipitation reaction.

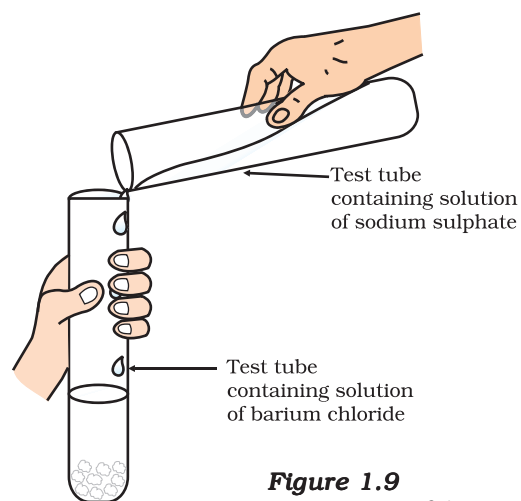
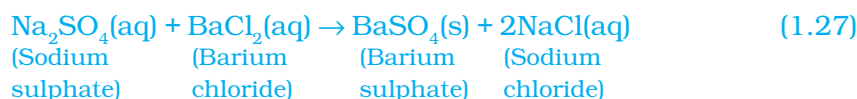

Figure 1.9
Formation of barium sulphate and sodium chloride

What causes this? The white precipitate of BaSO_4 is formed by the reaction of SO_4^{2-} and Ba^{2+} . The other product formed is sodium chloride which remains in the solution. Such reactions in which there is an exchange of ions between the reactants are called double displacement reactions.

Recall Activity 1.2, where you have mixed the solutions of lead(II) nitrate and potassium iodide.

- What was the colour of the precipitate formed? Can you name the compound precipitated?
- Write the balanced chemical equation for this reaction.
- Is this also a double displacement reaction?

1.2.5 Oxidation and Reduction

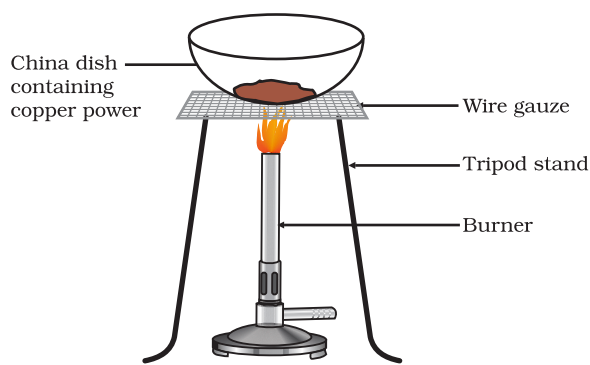

Figure 1.10
Oxidation of copper to copper oxide

Activity 1.11

- Heat a china dish containing about 1 g copper powder (Fig. 1.10).
- What do you observe?

The surface of copper powder becomes coated with black copper(II) oxide. Why has this black substance formed?

This is because oxygen is added to copper and copper oxide is formed.



If hydrogen gas is passed over this heated material (CuO), the black coating on the surface turns brown as the reverse reaction takes place and copper is obtained.



If a substance gains oxygen during a reaction, it is said to be oxidised. If a substance loses oxygen during a reaction, it is said to be reduced.

During this reaction (1.29), the copper(II) oxide is losing oxygen and is being reduced. The hydrogen is gaining oxygen and is being oxidised. In other words, one reactant gets oxidised while the other gets reduced during a reaction. Such reactions are called oxidation-reduction reactions or redox reactions.



Some other examples of redox reactions are:



In reaction (1.31) carbon is oxidised to CO and ZnO is reduced to Zn. In reaction (1.32) HCl is oxidised to Cl₂ whereas MnO₂ is reduced to MnCl₂.

From the above examples we can say that if a substance gains oxygen or loses hydrogen during a reaction, it is oxidised. If a substance loses oxygen or gains hydrogen during a reaction, it is reduced.

Recall Activity 1.1, where a magnesium ribbon burns with a dazzling flame in air (oxygen) and changes into a white substance, magnesium oxide. Is magnesium being oxidised or reduced in this reaction?

1.3 HAVE YOU OBSERVED THE EFFECTS OF OXIDATION REACTIONS IN EVERYDAY LIFE?

1.3.1 Corrosion

You must have observed that iron articles are shiny when new, but get coated with a reddish brown powder when left for some time. This process is commonly known as rusting of iron. Some other metals also get tarnished in this manner. Have you noticed the colour of the coating formed on copper and silver? When a metal is attacked by substances around it such as moisture, acids, etc., it is said to corrode and this process is called corrosion. The black coating on silver and the green coating on copper are other examples of corrosion.

Corrosion causes damage to car bodies, bridges, iron railings, ships and to all objects made of metals, specially those of iron. Corrosion of iron is a serious problem. Every year an enormous amount of money is spent to replace damaged iron. You will learn more about corrosion in Chapter 3.

1.3.2 Rancidity

Have you ever tasted or smelt the fat/oil containing food materials left for a long time?

When fats and oils are oxidised, they become rancid and their smell and taste change. Usually substances which prevent oxidation (antioxidants) are added to foods containing fats and oil. Keeping food in air tight containers helps to slow down oxidation. Do you know that chips manufacturers usually flush bags of chips with gas such as nitrogen to prevent the chips from getting oxidised ?

Q U E S T I O N S

1. Why does the colour of copper sulphate solution change when an iron nail is dipped in it?
2. Give an example of a double displacement reaction other than the one given in Activity 1.10.
3. Identify the substances that are oxidised and the substances that are reduced in the following reactions.
 - (i) $4\text{Na(s)} + \text{O}_2\text{(g)} \rightarrow 2\text{Na}_2\text{O(s)}$
 - (ii) $\text{CuO(s)} + \text{H}_2\text{(g)} \rightarrow \text{Cu(s)} + \text{H}_2\text{O(l)}$



What you have learnt

- A complete chemical equation represents the reactants, products and their physical states symbolically.
- A chemical equation is balanced so that the numbers of atoms of each type involved in a chemical reaction are the same on the reactant and product sides of the equation. Equations must always be balanced.
- In a combination reaction two or more substances combine to form a new single substance.
- Decomposition reactions are opposite to combination reactions. In a decomposition reaction, a single substance decomposes to give two or more substances.
- Reactions in which heat is given out along with the products are called exothermic reactions.
- Reactions in which energy is absorbed are known as endothermic reactions.
- When an element displaces another element from its compound, a displacement reaction occurs.
- Two different atoms or groups of atoms (ions) are exchanged in double displacement reactions.
- Precipitation reactions produce insoluble salts.
- Reactions also involve the gain or loss of oxygen or hydrogen by substances. Oxidation is the gain of oxygen or loss of hydrogen. Reduction is the loss of oxygen or gain of hydrogen.

EXERCISES

1. Which of the statements about the reaction below are incorrect?

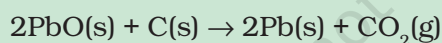

- (a) Lead is getting reduced.
- (b) Carbon dioxide is getting oxidised.
- (c) Carbon is getting oxidised.
- (d) Lead oxide is getting reduced.
 - (i) (a) and (b)
 - (ii) (a) and (c)
 - (iii) (a), (b) and (c)
 - (iv) all

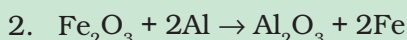

The above reaction is an example of a

- (a) combination reaction.
- (b) double displacement reaction.

- (c) decomposition reaction.
- (d) displacement reaction.
3. What happens when dilute hydrochloric acid is added to iron fillings? Tick the correct answer.
- (a) Hydrogen gas and iron chloride are produced.
- (b) Chlorine gas and iron hydroxide are produced.
- (c) No reaction takes place.
- (d) Iron salt and water are produced.
4. What is a balanced chemical equation? Why should chemical equations be balanced?
5. Translate the following statements into chemical equations and then balance them.
- (a) Hydrogen gas combines with nitrogen to form ammonia.
- (b) Hydrogen sulphide gas burns in air to give water and sulphur dioxide.
- (c) Barium chloride reacts with aluminium sulphate to give aluminium chloride and a precipitate of barium sulphate.
- (d) Potassium metal reacts with water to give potassium hydroxide and hydrogen gas.
6. Balance the following chemical equations.
- (a) $\text{HNO}_3 + \text{Ca}(\text{OH})_2 \rightarrow \text{Ca}(\text{NO}_3)_2 + \text{H}_2\text{O}$
- (b) $\text{NaOH} + \text{H}_2\text{SO}_4 \rightarrow \text{Na}_2\text{SO}_4 + \text{H}_2\text{O}$
- (c) $\text{NaCl} + \text{AgNO}_3 \rightarrow \text{AgCl} + \text{NaNO}_3$
- (d) $\text{BaCl}_2 + \text{H}_2\text{SO}_4 \rightarrow \text{BaSO}_4 + \text{HCl}$
7. Write the balanced chemical equations for the following reactions.
- (a) Calcium hydroxide + Carbon dioxide \rightarrow Calcium carbonate + Water
- (b) Zinc + Silver nitrate \rightarrow Zinc nitrate + Silver
- (c) Aluminium + Copper chloride \rightarrow Aluminium chloride + Copper
- (d) Barium chloride + Potassium sulphate \rightarrow Barium sulphate + Potassium chloride
8. Write the balanced chemical equation for the following and identify the type of reaction in each case.
- (a) Potassium bromide(aq) + Barium iodide(aq) \rightarrow Potassium iodide(aq) + Barium bromide(s)
- (b) Zinc carbonate(s) \rightarrow Zinc oxide(s) + Carbon dioxide(g)
- (c) Hydrogen(g) + Chlorine(g) \rightarrow Hydrogen chloride(g)
- (d) Magnesium(s) + Hydrochloric acid(aq) \rightarrow Magnesium chloride(aq) + Hydrogen(g)
9. What does one mean by exothermic and endothermic reactions? Give examples.
10. Why is respiration considered an exothermic reaction? Explain.
11. Why are decomposition reactions called the opposite of combination reactions? Write equations for these reactions.

12. Write one equation each for decomposition reactions where energy is supplied in the form of heat, light or electricity.
13. What is the difference between displacement and double displacement reactions? Write equations for these reactions.
14. In the refining of silver, the recovery of silver from silver nitrate solution involved displacement by copper metal. Write down the reaction involved.
15. What do you mean by a precipitation reaction? Explain by giving examples.
16. Explain the following in terms of gain or loss of oxygen with two examples each.
 - (a) Oxidation
 - (b) Reduction
17. A shiny brown coloured element 'X' on heating in air becomes black in colour. Name the element 'X' and the black coloured compound formed.
18. Why do we apply paint on iron articles?
19. Oil and fat containing food items are flushed with nitrogen. Why?
20. Explain the following terms with one example each.
 - (a) Corrosion
 - (b) Rancidity

Group Activity

Perform the following activity.

- Take four beakers and label them as A, B, C and D.
- Put 25 mL of water in A, B and C beakers and copper sulphate solution in beaker D.
- Measure and record the temperature of each liquid contained in the beakers above.
- Add two spatulas of potassium sulphate, ammonium nitrate, anhydrous copper sulphate and fine iron fillings to beakers A, B, C and D respectively and stir.
- Finally measure and record the temperature of each of the mixture above.

Find out which reactions are exothermic and which ones are endothermic in nature.

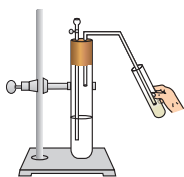

CHAPTER 2

Acids, Bases and Salts



1064CH02

You have learnt in your previous classes that the sour and bitter tastes of food are due to acids and bases, respectively, present in them.

If someone in the family is suffering from a problem of acidity after overeating, which of the following would you suggest as a remedy—lemon juice, vinegar or baking soda solution?

- Which property did you think of while choosing the remedy?
Surely you must have used your knowledge about the ability of acids and bases to nullify each other's effect.
- Recall how we tested sour and bitter substances without tasting them.

You already know that acids are sour in taste and change the colour of blue litmus to red, whereas, bases are bitter and change the colour of the red litmus to blue. Litmus is a natural indicator, turmeric is another such indicator. Have you noticed that a stain of curry on a white cloth becomes reddish-brown when soap, which is basic in nature, is scrubbed on it? It turns yellow again when the cloth is washed with plenty of water. You can also use synthetic indicators such as methyl orange and phenolphthalein to test for acids and bases.

In this Chapter, we will study the reactions of acids and bases, how acids and bases cancel out each other's effects and many more interesting things that we use and see in our day-to-day life.

Do You Know?

Litmus solution is a purple dye, which is extracted from lichen, a plant belonging to the division Thallophyta, and is commonly used as an indicator. When the litmus solution is neither acidic nor basic, its colour is purple. There are many other natural materials like red cabbage leaves, turmeric, coloured petals of some flowers such as *Hydrangea*, *Petunia* and *Geranium*, which indicate the presence of acid or base in a solution. These are called acid-base indicators or sometimes simply indicators.

Q U E S T I O N

1. You have been provided with three test tubes. One of them contains distilled water and the other two contain an acidic solution and a basic solution, respectively. If you are given only red litmus paper, how will you identify the contents of each test tube?



2.1 UNDERSTANDING THE CHEMICAL PROPERTIES OF ACIDS AND BASES

2.1.1 Acids and Bases in the Laboratory

Activity 2.1

- Collect the following solutions from the science laboratory—hydrochloric acid (HCl), sulphuric acid (H_2SO_4), nitric acid (HNO_3), acetic acid (CH_3COOH), sodium hydroxide (NaOH), calcium hydroxide [$\text{Ca}(\text{OH})_2$], potassium hydroxide (KOH), magnesium hydroxide [$\text{Mg}(\text{OH})_2$], and ammonium hydroxide (NH_4OH).
- Put a drop of each of the above solutions on a watch-glass one by one and test with a drop of the indicators shown in Table 2.1.
- What change in colour did you observe with red litmus, blue litmus, phenolphthalein and methyl orange solutions for each of the solutions taken?
- Tabulate your observations in Table 2.1.

Table 2.1

Sample solution	Red litmus solution	Blue litmus solution	Phenolphthalein solution	Methyl orange solution

These indicators tell us whether a substance is acidic or basic by change in colour. There are some substances whose odour changes in acidic or basic media. These are called olfactory indicators. Let us try out some of these indicators.

Activity 2.2

- Take some finely chopped onions in a plastic bag along with some strips of clean cloth. Tie up the bag tightly and leave overnight in the fridge. The cloth strips can now be used to test for acids and bases.
- Take two of these cloth strips and check their odour.
- Keep them on a clean surface and put a few drops of dilute HCl solution on one strip and a few drops of dilute NaOH solution on the other.

- Rinse both cloth strips with water and again check their odour.
- Note your observations.
- Now take some dilute vanilla essence and clove oil and check their odour.
- Take some dilute HCl solution in one test tube and dilute NaOH solution in another. Add a few drops of dilute vanilla essence to both test tubes and shake well. Check the odour once again and record changes in odour, if any.
- Similarly, test the change in the odour of clove oil with dilute HCl and dilute NaOH solutions and record your observations.

Which of these – vanilla, onion and clove, can be used as olfactory indicators on the basis of your observations?

Let us do some more activities to understand the chemical properties of acids and bases.

2.1.2 How do Acids and Bases React with Metals?

Activity 2.3

CAUTION: This activity needs the teacher's assistance.

- Set the apparatus as shown in Fig. 2.1.
- Take about 5 mL of dilute sulphuric acid in a test tube and add a few pieces of zinc granules to it.
- What do you observe on the surface of zinc granules?
- Pass the gas being evolved through the soap solution.
- Why are bubbles formed in the soap solution?
- Take a burning candle near a gas filled bubble.
- What do you observe?
- Repeat this Activity with some more acids like HCl, HNO₃ and CH₃COOH.
- Are the observations in all the cases the same or different?

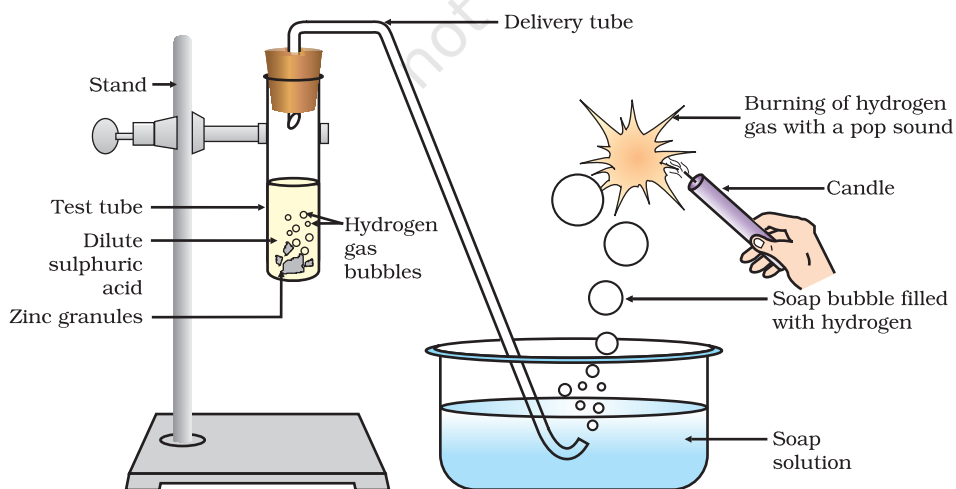

Figure 2.1 Reaction of zinc granules with dilute sulphuric acid and testing hydrogen gas by burning

Note that the metal in the above reactions displaces hydrogen atoms from the acids as hydrogen gas and forms a compound called a salt. Thus, the reaction of a metal with an acid can be summarised as –



Can you now write the equations for the reactions you have observed?

Activity 2.4

- Place a few pieces of granulated zinc metal in a test tube.
- Add 2 mL of sodium hydroxide solution and warm the contents of the test tube.
- Repeat the rest of the steps as in Activity 2.3 and record your observations.

The reaction that takes place can be written as follows.

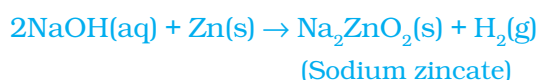

You find again that hydrogen is formed in the reaction. However, such reactions are not possible with all metals.

2.1.3 How do Metal Carbonates and Metal Hydrogencarbonates React with Acids?

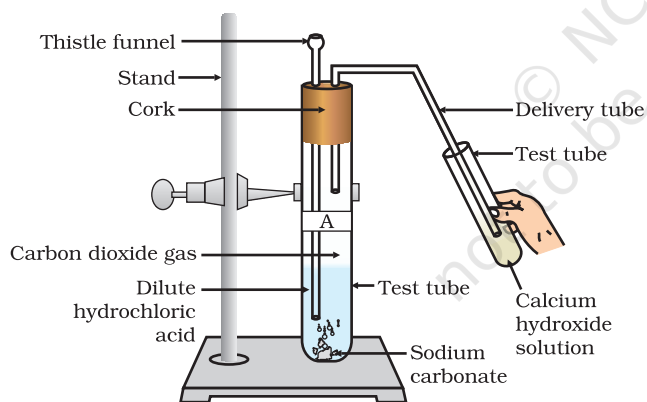

Figure 2.2
Passing carbon dioxide gas through calcium hydroxide solution

Activity 2.5

- Take two test tubes, label them as A and B.
- Take about 0.5 g of sodium carbonate (Na_2CO_3) in test tube A and about 0.5 g of sodium hydrogencarbonate (NaHCO_3) in test tube B.
- Add about 2 mL of dilute HCl to both the test tubes.
- What do you observe?
- Pass the gas produced in each case through lime water (calcium hydroxide solution) as shown in Fig. 2.2 and record your observations.

The reactions occurring in the above Activity are written as –



On passing the carbon dioxide gas evolved through lime water,

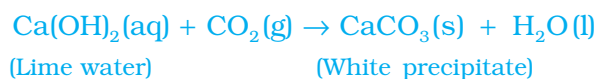

On passing excess carbon dioxide the following reaction takes place:

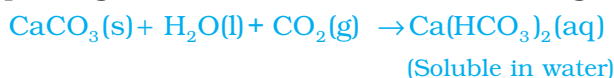

Limestone, chalk and marble are different forms of calcium carbonate. All metal carbonates and hydrogencarbonates react with acids to give a corresponding salt, carbon dioxide and water.

Thus, the reaction can be summarised as –



2.1.4 How do Acids and Bases React with each other?

Activity 2.6

- Take about 2 mL of dilute NaOH solution in a test tube and add two drops of phenolphthalein solution.
- What is the colour of the solution?
- Add dilute HCl solution to the above solution drop by drop.
- Is there any colour change for the reaction mixture?
- Why did the colour of phenolphthalein change after the addition of an acid?
- Now add a few drops of NaOH to the above mixture.
- Does the pink colour of phenolphthalein reappear?
- Why do you think this has happened?

In the above Activity, we have observed that the effect of a base is nullified by an acid and vice-versa. The reaction taking place is written as –

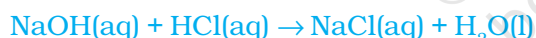

The reaction between an acid and a base to give a salt and water is known as a neutralisation reaction. In general, a neutralisation reaction can be written as –



2.1.5 Reaction of Metallic Oxides with Acids

Activity 2.7

- Take a small amount of copper oxide in a beaker and add dilute hydrochloric acid slowly while stirring.
- Note the colour of the solution. What has happened to the copper oxide?

You will notice that the colour of the solution becomes blue-green and the copper oxide dissolves. The blue-green colour of the solution is due to the formation of copper(II) chloride in the reaction. The general reaction between a metal oxide and an acid can be written as –



Now write and balance the equation for the above reaction. Since metallic oxides react with acids to give salts and water, similar to the reaction of a base with an acid, metallic oxides are said to be basic oxides.

2.1.6 Reaction of a Non-metallic Oxide with Base

You saw the reaction between carbon dioxide and calcium hydroxide (lime water) in Activity 2.5. Calcium hydroxide, which is a base, reacts with carbon dioxide to produce a salt and water. Since this is similar to the reaction between a base and an acid, we can conclude that non-metallic oxides are acidic in nature.

Q U E S T I O N S

1. Why should curd and sour substances not be kept in brass and copper vessels?
2. Which gas is usually liberated when an acid reacts with a metal? Illustrate with an example. How will you test for the presence of this gas?
3. Metal compound A reacts with dilute hydrochloric acid to produce effervescence. The gas evolved extinguishes a burning candle. Write a balanced chemical equation for the reaction if one of the compounds formed is calcium chloride.



2.2 WHAT DO ALL ACIDS AND ALL BASES HAVE IN COMMON?

In Section 2.1 we have seen that all acids have similar chemical properties. What leads to this similarity in properties? We saw in Activity 2.3 that all acids generate hydrogen gas on reacting with metals, so hydrogen seems to be common to all acids. Let us perform an Activity to investigate whether all compounds containing hydrogen are acidic.

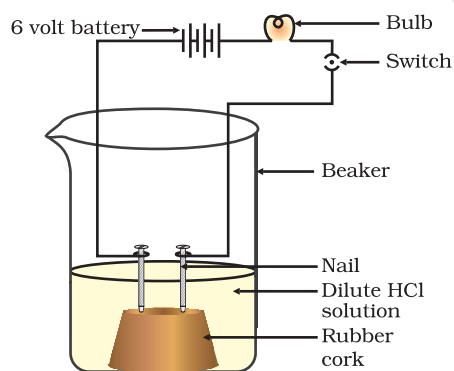

Figure 2.3
Acid solution in water conducts electricity

Activity 2.8

- Take solutions of glucose, alcohol, hydrochloric acid, sulphuric acid, etc.
- Fix two nails on a cork, and place the cork in a 100 mL beaker.
- Connect the nails to the two terminals of a 6 volt battery through a bulb and a switch, as shown in Fig. 2.3.
- Now pour some dilute HCl in the beaker and switch on the current.
- Repeat with dilute sulphuric acid.
- What do you observe?
- Repeat the experiment separately with glucose and alcohol solutions. What do you observe now?
- Does the bulb glow in all cases?

The bulb will start glowing in the case of acids, as shown in Fig. 2.3. But you will observe that glucose and alcohol solutions do not conduct electricity. Glowing of the bulb indicates that there is a flow of electric current through the solution. The electric current is carried through the acidic solution by ions.

Acids contain H^+ ion as cation and anion such as Cl^- in HCl , NO_3^- in HNO_3 , SO_4^{2-} in H_2SO_4 , CH_3COO^- in CH_3COOH . Since the cation present in acids is H^+ , this suggests that acids produce hydrogen ions, $H^+(aq)$, in solution, which are responsible for their acidic properties.

Repeat the same Activity using alkalis such as sodium hydroxide, calcium hydroxide, etc. What can you conclude from the results of this Activity?

2.2.1 What Happens to an Acid or a Base in a Water Solution?

Do acids produce ions only in aqueous solution? Let us test this.

Activity 2.9

- Take about 1g solid $NaCl$ in a clean and dry test tube and set up the apparatus as shown in Fig. 2.4.
- Add some concentrated sulphuric acid to the test tube.
- What do you observe? Is there a gas coming out of the delivery tube?
- Test the gas evolved successively with dry and wet blue litmus paper.
- In which case does the litmus paper change colour?
- On the basis of the above Activity, what do you infer about the acidic character of:
 - (i) dry HCl gas
 - (ii) HCl solution?

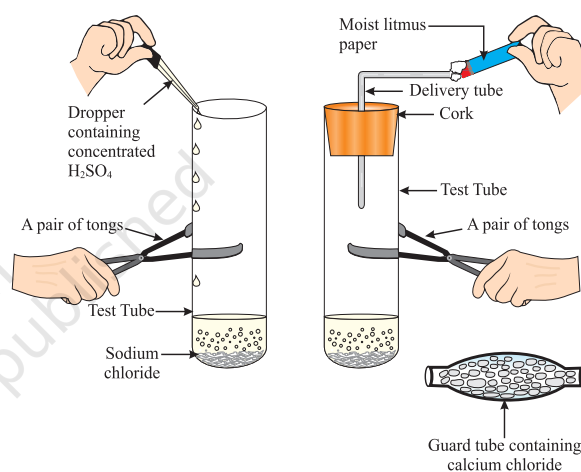

Figure 2.4 Preparation of HCl gas

Note to teachers: If the climate is very humid, you will have to pass the gas produced through a guard tube (drying tube) containing calcium chloride to dry the gas.

This experiment suggests that hydrogen ions in HCl are produced in the presence of water. The separation of H^+ ion from HCl molecules cannot occur in the absence of water.



Hydrogen ions cannot exist alone, but they exist after combining with water molecules. Thus hydrogen ions must always be shown as $H^+(aq)$ or hydronium ion (H_3O^+).



We have seen that acids give H_3O^+ or $H^+(aq)$ ion in water. Let us see what happens when a base is dissolved in water.





Bases generate hydroxide (OH⁻) ions in water. Bases which are soluble in water are called alkalis.

Do You Know?

All bases do not dissolve in water. An alkali is a base that dissolves in water. They are soapy to touch, bitter and corrosive. Never taste or touch them as they may cause harm. Which of the bases in the Table 2.1 are alkalis?

Now as we have identified that all acids generate H⁺(aq) and all bases generate OH⁻(aq), we can view the neutralisation reaction as follows –

Acid + Base → Salt + Water



Let us see what is involved when water is mixed with an acid or a base.



Figure 2.5
Warning sign displayed on containers containing concentrated acids and bases

Activity 2.10

- Take 10 mL water in a beaker.
- Add a few drops of concentrated H₂SO₄ to it and swirl the beaker slowly.
- Touch the base of the beaker.
- Is there a change in temperature?
- Is this an exothermic or endothermic process?
- Repeat the above Activity with sodium hydroxide pellets and record your observations.

The process of dissolving an acid or a base in water is a highly exothermic one. Care must be taken while mixing concentrated nitric acid or sulphuric acid with water. The acid must always be added slowly to water with constant stirring. If water is added to a concentrated acid, the heat generated may cause the mixture to splash out and cause burns. The glass container may also break due to excessive local heating. Look out for the warning sign (shown in Fig. 2.5) on the can of concentrated sulphuric acid and on the bottle of sodium hydroxide pellets.

Mixing an acid or base with water results in decrease in the concentration of ions (H₃O⁺/OH⁻) per unit volume. Such a process is called dilution and the acid or the base is said to be diluted.

Q U E S T I O N S

1. Why do HCl, HNO₃, etc., show acidic characters in aqueous solutions while solutions of compounds like alcohol and glucose do not show acidic character?
2. Why does an aqueous solution of an acid conduct electricity?
3. Why does dry HCl gas not change the colour of the dry litmus paper?
4. While diluting an acid, why is it recommended that the acid should be added to water and not water to the acid?
5. How is the concentration of hydronium ions (H₃O⁺) affected when a solution of an acid is diluted?
6. How is the concentration of hydroxide ions (OH⁻) affected when excess base is dissolved in a solution of sodium hydroxide?



2.3 HOW STRONG ARE ACID OR BASE SOLUTIONS?

We know how acid-base indicators can be used to distinguish between an acid and a base. We have also learnt in the previous section about dilution and decrease in concentration of H⁺ or OH⁻ ions in solutions. Can we quantitatively find the amount of these ions present in a solution? Can we judge how strong a given acid or base is?

We can do this by making use of a universal indicator, which is a mixture of several indicators. The universal indicator shows different colours at different concentrations of hydrogen ions in a solution.

A scale for measuring hydrogen ion concentration in a solution, called pH scale has been developed. The p in pH stands for '*potenz*' in German, meaning power. On the pH scale we can measure pH generally from 0 (very acidic) to 14 (very alkaline). pH should be thought of simply as a number which indicates the acidic or basic nature of a solution. Higher the hydronium ion concentration, lower is the pH value.

The pH of a neutral solution is 7. Values less than 7 on the pH scale represent an acidic solution. As the pH value increases from 7 to 14, it represents an increase in OH⁻ ion concentration in the solution, that is, increase in the strength of alkali (Fig. 2.6). Generally paper impregnated with the universal indicator is used for measuring pH.

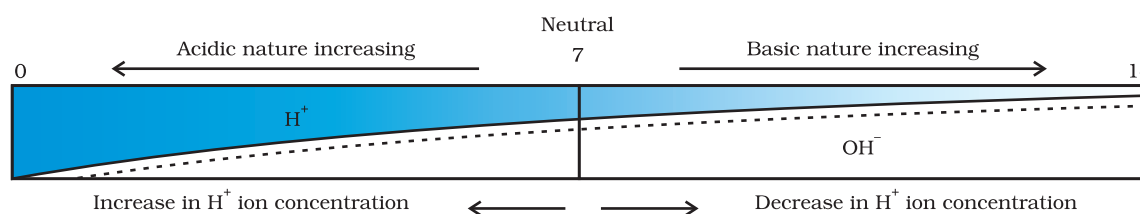

Figure 2.6 Variation of pH with the change in concentration of H⁺(aq) and OH⁻(aq) ions

Activity 2.11

- Test the pH values of solutions given in Table 2.2.
- Record your observations.
- What is the nature of each substance on the basis of your observations?

Table 2.2

S. No.	Solution	Colour of pH paper	Approximate pH value	Nature of substance
1	Saliva (before meal)			
2	Saliva (after meal)			
3	Lemon juice			
4	Colourless aerated drink			
5	Carrot juice			
6	Coffee			
7	Tomato juice			
8	Tap water			
9	1M NaOH			
10	1M HCl			

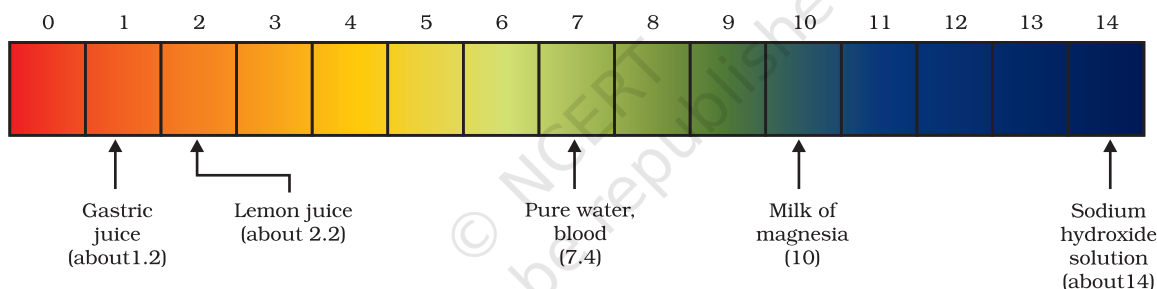

Figure 2.7 pH of some common substances shown on a pH paper (colours are only a rough guide)

The strength of acids and bases depends on the number of H^+ ions and OH^- ions produced, respectively. If we take hydrochloric acid and acetic acid of the same concentration, say one molar, then these produce different amounts of hydrogen ions. Acids that give rise to more H^+ ions are said to be strong acids, and acids that give less H^+ ions are said to be weak acids. Can you now say what weak and strong bases are?

2.3.1 Importance of pH in Everyday Life

Are plants and animals pH sensitive?

Our body works within the pH range of 7.0 to 7.8. Living organisms can survive only in a narrow range of pH change. When pH of rain water is less than 5.6, it is called acid rain. When acid rain flows into the rivers, it lowers the pH of the river water. The survival of aquatic life in such rivers becomes difficult.

Acids in other planets

The atmosphere of venus is made up of thick white and yellowish clouds of sulphuric acid. Do you think life can exist on this planet?

What is the pH of the soil in your backyard?

Plants require a specific pH range for their healthy growth. To find out the pH required for the healthy growth of a plant, you can collect the soil from various places and check the pH in the manner described below in Activity 2.12. Also, you can note down which plants are growing in the region from which you have collected the soil.

Activity 2.12

- Put about 2 g soil in a test tube and add 5 mL water to it.
- Shake the contents of the test tube.
- Filter the contents and collect the filtrate in a test tube.
- Check the pH of this filtrate with the help of universal indicator paper.
- What can you conclude about the ideal soil pH for the growth of plants in your region?

pH in our digestive system

It is very interesting to note that our stomach produces hydrochloric acid. It helps in the digestion of food without harming the stomach. During indigestion the stomach produces too much acid and this causes pain and irritation. To get rid of this pain, people use bases called antacids. One such remedy must have been suggested by you at the beginning of this Chapter. These antacids neutralise the excess acid. Magnesium hydroxide (Milk of magnesia), a mild base, is often used for this purpose.

pH change as the cause of tooth decay

Tooth decay starts when the pH of the mouth is lower than 5.5. Tooth enamel, made up of calcium hydroxyapatite (a crystalline form of calcium phosphate) is the hardest substance in the body. It does not dissolve in water, but is corroded when the pH in the mouth is below 5.5. Bacteria present in the mouth produce acids by degradation of sugar and food particles remaining in the mouth after eating. The best way to prevent this is to clean the mouth after eating food. Using toothpastes, which are generally basic, for cleaning the teeth can neutralise the excess acid and prevent tooth decay.

Self defence by animals and plants through chemical warfare

Have you ever been stung by a honey-bee? Bee-sting leaves an acid which causes pain and irritation. Use of a mild base like baking soda on the stung area gives relief. Stinging hair of nettle leaves inject methanoic acid causing burning pain.

Do You Know?



Nature provides neutralisation options

Nettle is a herbaceous plant which grows in the wild. Its leaves have stinging hair, which cause painful stings when touched accidentally. This is due to the methanoic acid secreted by them. A traditional remedy is rubbing the area with the leaf of the dock plant, which often grows beside the nettle in the wild. Can you guess the nature of the dock plant? So next time you know what to look out for if you accidentally touch a nettle plant while trekking. Are you aware of any other effective traditional remedies for such stings?

Table 2.3 Some naturally occurring acids

Natural source	Acid	Natural source	Acid
Vinegar	Acetic acid	Sour milk (Curd)	Lactic acid
Orange	Citric acid	Lemon	Citric acid
Tamarind	Tartaric acid	Ant sting	Methanoic acid
Tomato	Oxalic acid	Nettle sting	Methanoic acid

Q U E S T I O N S

1. You have two solutions, A and B. The pH of solution A is 6 and pH of solution B is 8. Which solution has more hydrogen ion concentration? Which of this is acidic and which one is basic?
2. What effect does the concentration of $H^+(aq)$ ions have on the nature of the solution?
3. Do basic solutions also have $H^+(aq)$ ions? If yes, then why are these basic?
4. Under what soil condition do you think a farmer would treat the soil of his fields with quick lime (calcium oxide) or slaked lime (calcium hydroxide) or chalk (calcium carbonate)?



2.4 MORE ABOUT SALTS

In the previous sections we have seen the formation of salts during various reactions. Let us understand more about their preparation, properties and uses.

2.4.1 Family of Salts

Activity 2.13

- Write the chemical formulae of the salts given below. Potassium sulphate, sodium sulphate, calcium sulphate, magnesium sulphate, copper sulphate, sodium chloride, sodium nitrate, sodium carbonate and ammonium chloride.

- Identify the acids and bases from which the above salts may be obtained.
- Salts having the same positive or negative radicals are said to belong to a family. For example, NaCl and Na₂SO₄ belong to the family of sodium salts. Similarly, NaCl and KCl belong to the family of chloride salts. How many families can you identify among the salts given in this Activity?

2.4.2 pH of Salts

Activity 2.14

- Collect the following salt samples – sodium chloride, potassium nitrate, aluminium chloride, zinc sulphate, copper sulphate, sodium acetate, sodium carbonate and sodium hydrogencarbonate (some other salts available can also be taken).
- Check their solubility in water (use distilled water only).
- Check the action of these solutions on litmus and find the pH using a pH paper.
- Which of the salts are acidic, basic or neutral?
- Identify the acid or base used to form the salt.
- Report your observations in Table 2.4.

Salts of a strong acid and a strong base are neutral with pH value of 7. On the other hand, salts of a strong acid and weak base are acidic with pH value less than 7 and those of a strong base and weak acid are basic in nature, with pH value more than 7.

Table 2.4

Salt	pH	Acid used	Base used

2.4.3 Chemicals from Common Salt

By now you have learnt that the salt formed by the combination of hydrochloric acid and sodium hydroxide solution is called sodium chloride. This is the salt that you use in food. You must have observed in the above Activity that it is a neutral salt.

Seawater contains many salts dissolved in it. Sodium chloride is separated from these salts. Deposits of solid salt are also found in several parts of the world. These large crystals are often brown due to impurities. This is called rock salt. Beds of rock salt were formed when seas of bygone ages dried up. Rock salt is mined like coal.

You must have heard about Mahatma Gandhi's *Dandi March*. Did you know that sodium chloride was such an important symbol in our struggle for freedom?



Common salt — A raw material for chemicals

The common salt thus obtained is an important raw material for various materials of daily use, such as sodium hydroxide, baking soda, washing soda, bleaching powder and many more. Let us see how one substance is used for making all these different substances.

Sodium hydroxide

When electricity is passed through an aqueous solution of sodium chloride (called brine), it decomposes to form sodium hydroxide. The process is called the chlor-alkali process because of the products formed—chlor for chlorine and alkali for sodium hydroxide.



Chlorine gas is given off at the anode, and hydrogen gas at the cathode. Sodium hydroxide solution is formed near the cathode. The three products produced in this process are all useful. Figure 2.8 shows the different uses of these products.

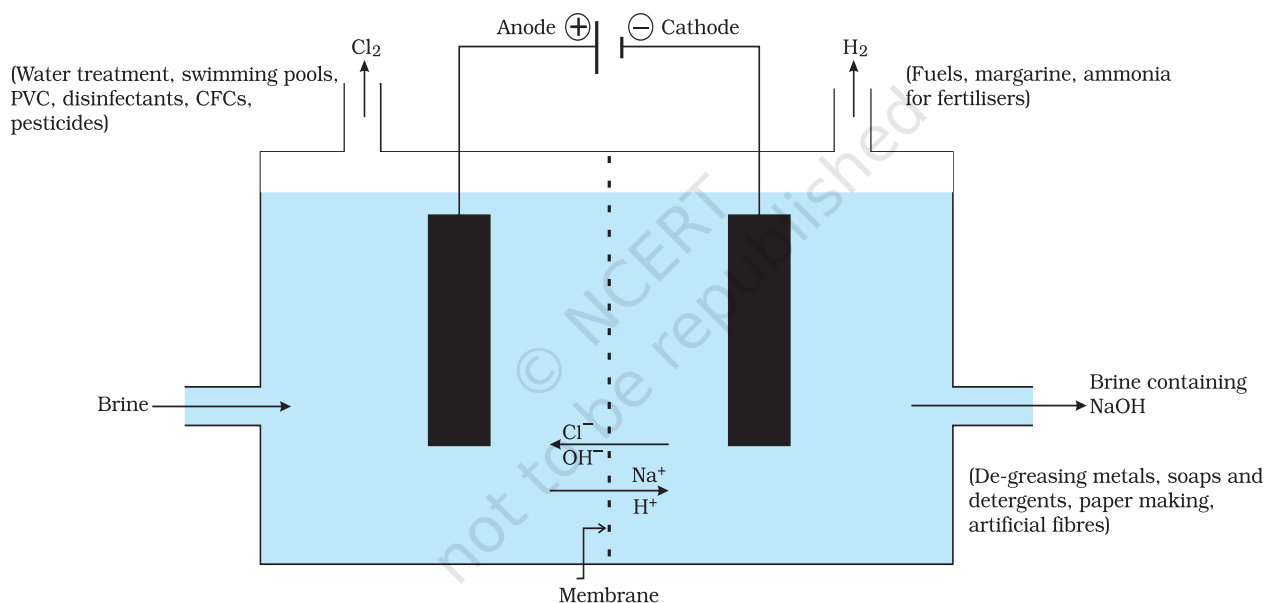

Figure 2.8 Important products from the chlor-alkali process

Bleaching powder

You have already come to know that chlorine is produced during the electrolysis of aqueous sodium chloride (brine). This chlorine gas is used for the manufacture of bleaching powder. Bleaching powder is produced by the action of chlorine on dry slaked lime [$\text{Ca}(\text{OH})_2$]. Bleaching powder is represented as CaOCl_2 , though the actual composition is quite complex.



Bleaching powder is used –

- (i) for bleaching cotton and linen in the textile industry, for bleaching wood pulp in paper factories and for bleaching washed clothes in laundry;
- (ii) as an oxidising agent in many chemical industries; and
- (iii) to make drinking water free from germs.

Baking soda

The baking soda is commonly used in the kitchen for making tasty crispy pakoras, etc. Sometimes it is added for faster cooking. The chemical name of the compound is sodium hydrogencarbonate (NaHCO_3). It is produced using sodium chloride as one of the raw materials.

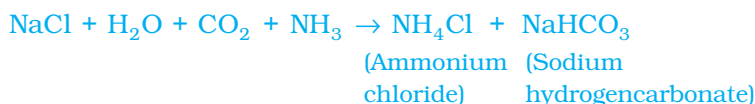

Did you check the pH of sodium hydrogencarbonate in Activity 2.14? Can you correlate why it can be used to neutralise an acid? It is a mild non-corrosive basic salt. The following reaction takes place when it is heated during cooking –

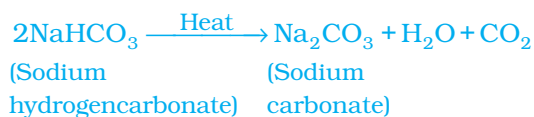

Sodium hydrogencarbonate has got various uses in the household.

Uses of Baking soda

- (i) For making baking powder, which is a mixture of baking soda (sodium hydrogencarbonate) and a mild edible acid such as tartaric acid. When baking powder is heated or mixed in water, the following reaction takes place –

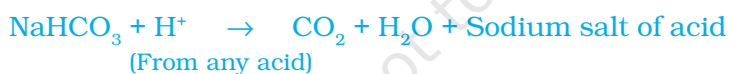

Carbon dioxide produced during the reaction can cause bread or cake to rise making them soft and spongy.

- (ii) Sodium hydrogencarbonate is also an ingredient in antacids. Being alkaline, it neutralises excess acid in the stomach and provides relief.
- (iii) It is also used in soda-acid fire extinguishers.

Washing soda

Another chemical that can be obtained from sodium chloride is $\text{Na}_2\text{CO}_3 \cdot 10\text{H}_2\text{O}$ (washing soda). You have seen above that sodium carbonate can be obtained by heating baking soda; recrystallisation of sodium carbonate gives washing soda. It is also a basic salt.

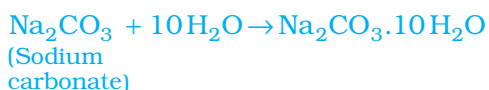

What does $10\text{H}_2\text{O}$ signify? Does it make Na_2CO_3 wet? We will address this question in the next section.

Sodium carbonate and sodium hydrogencarbonate are useful chemicals for many industrial processes as well.

Uses of washing soda

- (i) Sodium carbonate (washing soda) is used in glass, soap and paper industries.
- (ii) It is used in the manufacture of sodium compounds such as borax.
- (iii) Sodium carbonate can be used as a cleaning agent for domestic purposes.
- (iv) It is used for removing permanent hardness of water.

2.4.4 Are the Crystals of Salts really Dry?

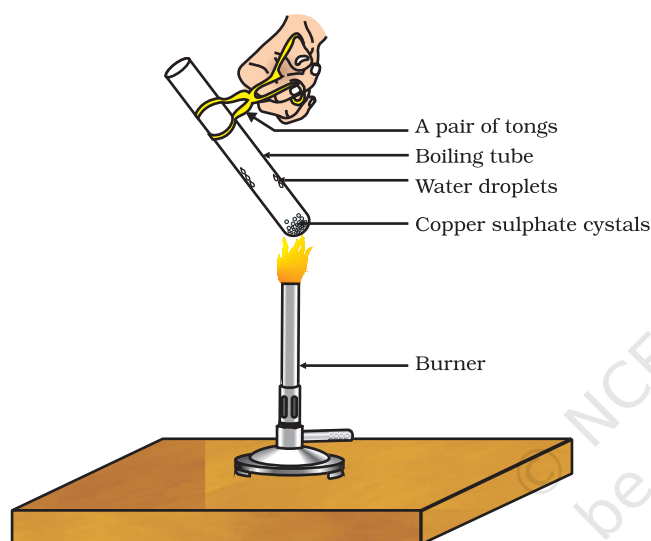

Figure 2.9
Removing water
of crystallisation

Copper sulphate crystals which seem to be dry contain water of crystallisation. When we heat the crystals, this water is removed and the salt turns white.

If you moisten the crystals again with water, you will find that blue colour of the crystals reappears.

Water of crystallisation is the fixed number of water molecules present in one formula unit of a salt. Five water molecules are present in one formula unit of copper sulphate. Chemical formula for hydrated copper sulphate is $\text{CuSO}_4 \cdot 5\text{H}_2\text{O}$. Now you would be able to answer the question whether the molecule of $\text{Na}_2\text{CO}_3 \cdot 10\text{H}_2\text{O}$ is wet.

One other salt, which possesses water of crystallisation is gypsum. It has two water molecules as water of crystallisation. It has the chemical formula $\text{CaSO}_4 \cdot 2\text{H}_2\text{O}$. Let us look into the use of this salt.

Plaster of Paris

On heating gypsum at 373 K, it loses water molecules and becomes calcium sulphate hemihydrate ($\text{CaSO}_4 \cdot \frac{1}{2} \text{H}_2\text{O}$). This is called Plaster of

Activity 2.15

- Heat a few crystals of copper sulphate in a dry boiling tube.
- What is the colour of the copper sulphate after heating?
- Do you notice water droplets in the boiling tube? Where have these come from?
- Add 2-3 drops of water on the sample of copper sulphate obtained after heating.
- What do you observe? Is the blue colour of copper sulphate restored?

Paris, the substance which doctors use as plaster for supporting fractured bones in the right position. Plaster of Paris is a white powder and on mixing with water, it changes to gypsum once again giving a hard solid mass.

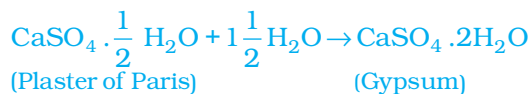

Note that only half a water molecule is shown to be attached as water of crystallisation. How can you get half a water molecule? It is written in this form because two formula units of CaSO_4 share one molecule of water. Plaster of Paris is used for making toys, materials for decoration and for making surfaces smooth. Try to find out why is calcium sulphate hemihydrate called 'Plaster of Paris' ?

Q U E S T I O N S

1. What is the common name of the compound CaOCl_2 ?
2. Name the substance which on treatment with chlorine yields bleaching powder.
3. Name the sodium compound which is used for softening hard water.
4. What will happen if a solution of sodium hydrocarbonate is heated? Give the equation of the reaction involved.
5. Write an equation to show the reaction between Plaster of Paris and water.



What you have learnt

- Acid-base indicators are dyes or mixtures of dyes which are used to indicate the presence of acids and bases.
- Acidic nature of a substance is due to the formation of $\text{H}^+(\text{aq})$ ions in solution. Formation of $\text{OH}^-(\text{aq})$ ions in solution is responsible for the basic nature of a substance.
- When an acid reacts with a metal, hydrogen gas is evolved and a corresponding salt is formed.
- When a base reacts with a metal, along with the evolution of hydrogen gas a salt is formed which has a negative ion composed of the metal and oxygen.
- When an acid reacts with a metal carbonate or metal hydrogencarbonate, it gives the corresponding salt, carbon dioxide gas and water.
- Acidic and basic solutions in water conduct electricity because they produce hydrogen and hydroxide ions respectively.

- The strength of an acid or an alkali can be tested by using a scale called the pH scale (0-14) which gives the measure of hydrogen ion concentration in a solution.
- A neutral solution has a pH of exactly 7, while an acidic solution has a pH less than 7 and a basic solution a pH more than 7.
- Living beings carry out their metabolic activities within an optimal pH range.
- Mixing concentrated acids or bases with water is a highly exothermic process.
- Acids and bases neutralise each other to form corresponding salts and water.
- Water of crystallisation is the fixed number of water molecules present in one formula unit of a salt.
- Salts have various uses in everyday life and in industries.

E X E R C I S E S

1. A solution turns red litmus blue, its pH is likely to be
(a) 1 (b) 4 (c) 5 (d) 10
2. A solution reacts with crushed egg-shells to give a gas that turns lime-water milky. The solution contains
(a) NaCl (b) HCl (c) LiCl (d) KCl
3. 10 mL of a solution of NaOH is found to be completely neutralised by 8 mL of a given solution of HCl. If we take 20 mL of the same solution of NaOH, the amount HCl solution (the same solution as before) required to neutralise it will be
(a) 4 mL (b) 8 mL (c) 12 mL (d) 16 mL
4. Which one of the following types of medicines is used for treating indigestion?
(a) Antibiotic
(b) Analgesic
(c) Antacid
(d) Antiseptic
5. Write word equations and then balanced equations for the reaction taking place when –
(a) dilute sulphuric acid reacts with zinc granules.
(b) dilute hydrochloric acid reacts with magnesium ribbon.
(c) dilute sulphuric acid reacts with aluminium powder.
(d) dilute hydrochloric acid reacts with iron filings.
6. Compounds such as alcohols and glucose also contain hydrogen but are not categorised as acids. Describe an Activity to prove it.
7. Why does distilled water not conduct electricity, whereas rain water does?

8. Why do acids not show acidic behaviour in the absence of water?
9. Five solutions A,B,C,D and E when tested with universal indicator showed pH as 4, 1, 11, 7 and 9, respectively. Which solution is
- neutral?
 - strongly alkaline?
 - strongly acidic?
 - weakly acidic?
 - weakly alkaline?
- Arrange the pH in increasing order of hydrogen-ion concentration.
10. Equal lengths of magnesium ribbons are taken in test tubes A and B. Hydrochloric acid (HCl) is added to test tube A, while acetic acid (CH_3COOH) is added to test tube B. Amount and concentration taken for both the acids are same. In which test tube will the fizzing occur more vigorously and why?
11. Fresh milk has a pH of 6. How do you think the pH will change as it turns into curd? Explain your answer.
12. A milkman adds a very small amount of baking soda to fresh milk.
- Why does he shift the pH of the fresh milk from 6 to slightly alkaline?
 - Why does this milk take a long time to set as curd?
13. Plaster of Paris should be stored in a moisture-proof container. Explain why?
14. What is a neutralisation reaction? Give two examples.
15. Give two important uses of washing soda and baking soda.

Group Activity

(I) Prepare your own indicator

- Crush beetroot in a mortar.
- Add sufficient water to obtain the extract.
- Filter the extract by the procedure learnt by you in earlier classes.
- Collect the filtrate to test the substances you may have tasted earlier.
- Arrange four test tubes in a test tube stand and label them as A,B,C and D. Pour 2 mL each of lemon juice solution, soda-water, vinegar and baking soda solution in them respectively.
- Put 2-3 drops of the beetroot extract in each test tube and note the colour change if any. Write your observation in a Table.
- You can prepare indicators by using other natural materials like extracts of red cabbage leaves, coloured petals of some flowers such as *Petunia*, *Hydrangea* and *Geranium*.

(II) Preparing a soda-acid fire extinguisher

The reaction of acids with metal hydrogencarbonates is used in the fire extinguishers which produce carbon dioxide.

- Take 20 mL of sodium hydrogencarbonate (NaHCO_3) solution in a wash-bottle.
- Suspend an ignition tube containing dilute sulphuric acid in the wash-bottle (Fig. 2.10).
- Close the mouth of the wash-bottle.
- Tilt the wash-bottle so that the acid from the ignition tube mixes with the sodium hydrogencarbonate solution below.
- You will notice discharge coming out of the nozzle.
- Direct this discharge on a burning candle. What happens?

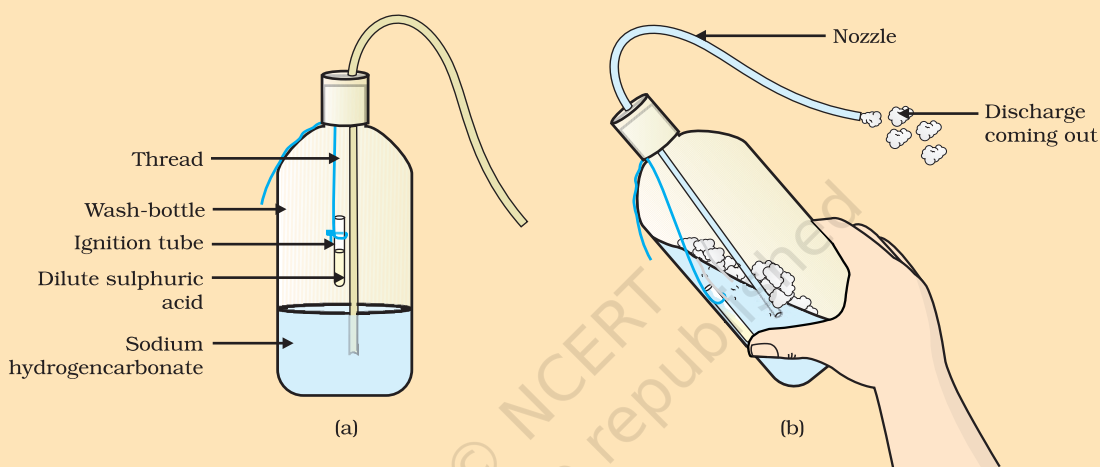
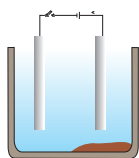

Figure 2.10 (a) Ignition tube containing dilute sulphuric acid suspended in a wash-bottle containing sodium hydrogencarbonate, (b) Discharge coming out of the nozzle

CHAPTER 3



Metals and Non-metals



1064CH03

In Class IX you have learnt about various elements. You have seen that elements can be classified as metals or non-metals on the basis of their properties.

- Think of some uses of metals and non-metals in your daily life.
- What properties did you think of while categorising elements as metals or non-metals?
- How are these properties related to the uses of these elements?

Let us look at some of these properties in detail.

3.1 PHYSICAL PROPERTIES

3.1.1 Metals

The easiest way to start grouping substances is by comparing their physical properties. Let us study this with the help of the following activities. For performing Activities 3.1 to 3.6, collect the samples of following metals – iron, copper, aluminium, magnesium, sodium, lead, zinc and any other metal that is easily available.

Activity 3.1

- Take samples of iron, copper, aluminium and magnesium. Note the appearance of each sample.
- Clean the surface of each sample by rubbing them with sand paper and note their appearance again.

Metals, in their pure state, have a shining surface. This property is called metallic lustre.

Activity 3.2

- Take small pieces of iron, copper, aluminium, and magnesium. Try to cut these metals with a sharp knife and note your observations.
- Hold a piece of sodium metal with a pair of tongs. **CAUTION:** Always handle sodium metal with care. Dry it by pressing between the folds of a filter paper.
- Put it on a watch-glass and try to cut it with a knife.
- What do you observe?

You will find that metals are generally hard. The hardness varies from metal to metal.

Activity 3.3

- Take pieces of iron, zinc, lead and copper.
- Place any one metal on a block of iron and strike it four or five times with a hammer. What do you observe?
- Repeat with other metals.
- Record the change in the shape of these metals.

You will find that some metals can be beaten into thin sheets. This property is called malleability. Did you know that gold and silver are the most malleable metals?

Activity 3.4

- List the metals whose wires you have seen in daily life.

The ability of metals to be drawn into thin wires is called ductility. Gold is the most ductile metal. You will be surprised to know that a wire of about 2 km length can be drawn from one gram of gold.

It is because of their malleability and ductility that metals can be given different shapes according to our needs.

Can you name some metals that are used for making cooking vessels? Do you know why these metals are used for making vessels? Let us do the following Activity to find out the answer.

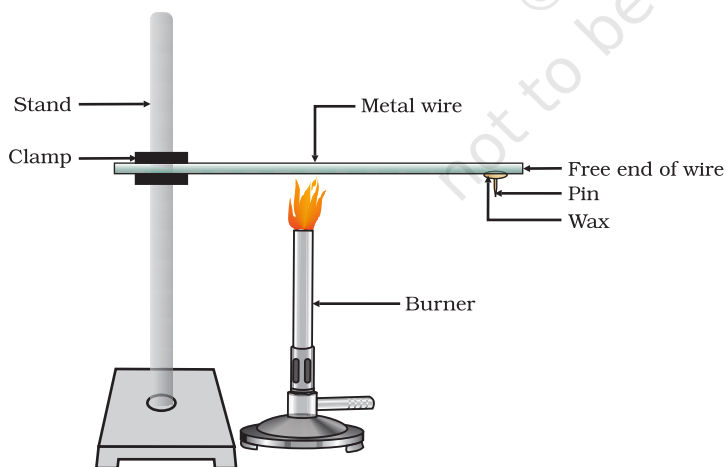

Figure 3.1
Metals are good conductors of heat.

Activity 3.5

- Take an aluminium or copper wire. Clamp this wire on a stand, as shown in Fig. 3.1.
- Fix a pin to the free end of the wire using wax.
- Heat the wire with a spirit lamp, candle or a burner near the place where it is clamped.
- What do you observe after some time?
- Note your observations. Does the metal wire melt?

The above activity shows that metals are good conductors of heat and have high melting points. The best conductors of heat are silver and copper. Lead and mercury are comparatively poor conductors of heat.

Do metals also conduct electricity? Let us find out.

Activity 3.6

- Set up an electric circuit as shown in Fig. 3.2.
- Place the metal to be tested in the circuit between terminals A and B as shown.
- Does the bulb glow? What does this indicate?

You must have seen that the wires that carry current in your homes have a coating of polyvinylchloride (PVC) or a rubber-like material. Why are electric wires coated with such substances?

What happens when metals strike a hard surface? Do they produce a sound? The metals that produce a sound on striking a hard surface are said to be sonorous. Can you now say why school bells are made of metals?

3.1.2 Non-metals

In the previous Class you have learnt that there are very few non-metals as compared to metals. Some of the examples of non-metals are carbon, sulphur, iodine, oxygen, hydrogen, etc. The non-metals are either solids or gases except bromine which is a liquid.

Do non-metals also have physical properties similar to that of metals? Let us find out.

Activity 3.7

- Collect samples of carbon (coal or graphite), sulphur and iodine.
- Carry out the Activities 3.1 to 3.4 and 3.6 with these non-metals and record your observations.

Compile your observations regarding metals and non-metals in Table 3.1.

Table 3.1

Element	Symbol	Type of surface	Hardness	Malleability	Ductility	Conducts Electricity	Sonority

On the bases of the observations recorded in Table 3.1, discuss the general physical properties of metals and non-metals in the class. You must have concluded that we cannot group elements according to their physical properties alone, as there are many exceptions. For example –

- All metals except mercury exist as solids at room temperature. In Activity 3.5, you have observed that metals have high melting

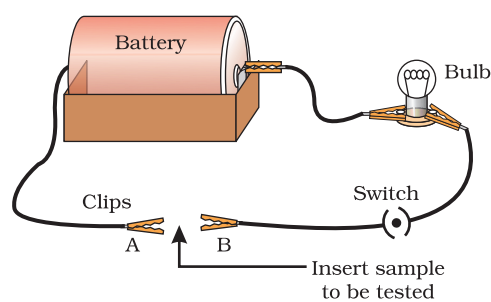

Figure 3.2
Metals are good conductors of electricity.

points but gallium and caesium have very low melting points. These two metals will melt if you keep them on your palm.

- (ii) Iodine is a non-metal but it is lustrous.
- (iii) Carbon is a non-metal that can exist in different forms. Each form is called an allotrope. Diamond, an allotrope of carbon, is the hardest natural substance known and has a very high melting and boiling point. Graphite, another allotrope of carbon, is a conductor of electricity.
- (iv) Alkali metals (lithium, sodium, potassium) are so soft that they can be cut with a knife. They have low densities and low melting points.

Elements can be more clearly classified as metals and non-metals on the basis of their chemical properties.

Activity 3.8

- Take a magnesium ribbon and some sulphur powder.
- Burn the magnesium ribbon. Collect the ashes formed and dissolve them in water.
- Test the resultant solution with both red and blue litmus paper.
- Is the product formed on burning magnesium acidic or basic?
- Now burn sulphur powder. Place a test tube over the burning sulphur to collect the fumes produced.
- Add some water to the above test tube and shake.
- Test this solution with blue and red litmus paper.
- Is the product formed on burning sulphur acidic or basic?
- Can you write equations for these reactions?

Most non-metals produce acidic oxides when dissolve in water. On the other hand, most metals, give rise to basic oxides. You will be learning more about these metal oxides in the next section.

Q U E S T I O N S

1. Give an example of a metal which
 - (i) is a liquid at room temperature.
 - (ii) can be easily cut with a knife.
 - (iii) is the best conductor of heat.
 - (iv) is a poor conductor of heat.
2. Explain the meanings of malleable and ductile.



3.2 CHEMICAL PROPERTIES OF METALS

We will learn about the chemical properties of metals in the following Sections 3.2.1 to 3.2.4. For this, collect the samples of following metals – aluminium, copper, iron, lead, magnesium, zinc and sodium.

3.2.1 What happens when Metals are burnt in Air?

You have seen in Activity 3.8 that magnesium burns in air with a dazzling white flame. Do all metals react in the same manner? Let us check by performing the following Activity.

Activity 3.9

CAUTION: The following activity needs the teacher's assistance. It would be better if students wear eye protection.

- Hold any of the samples taken above with a pair of tongs and try burning over a flame. Repeat with the other metal samples.
- Collect the product if formed.
- Let the products and the metal surface cool down.
- Which metals burn easily?
- What flame colour did you observe when the metal burnt?
- How does the metal surface appear after burning?
- Arrange the metals in the decreasing order of their reactivity towards oxygen.
- Are the products soluble in water?

Almost all metals combine with oxygen to form metal oxides.

Metal + Oxygen → Metal oxide

For example, when copper is heated in air, it combines with oxygen to form copper(II) oxide, a black oxide.

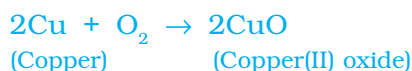

Similarly, aluminium forms aluminium oxide.

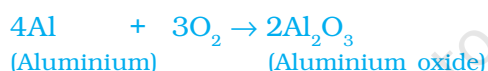

Recall from Chapter 2, how copper oxide reacts with hydrochloric acid. We have learnt that metal oxides are basic in nature. But some metal oxides, such as aluminium oxide, zinc oxide show both acidic as well as basic behaviour. Such metal oxides which react with both acids as well as bases to produce salts and water are known as amphoteric oxides. Aluminium oxide reacts in the following manner with acids and bases –

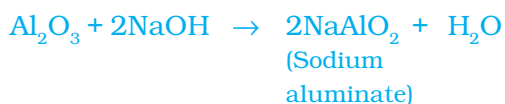

Most metal oxides are insoluble in water but some of these dissolve in water to form alkalis. Sodium oxide and potassium oxide dissolve in water to produce alkalis as follows –



We have observed in Activity 3.9 that all metals do not react with oxygen at the same rate. Different metals show different reactivities towards oxygen. Metals such as potassium and sodium react so vigorously that they catch fire if kept in the open. Hence, to protect them and to prevent accidental fires, they are kept immersed in kerosene oil. At ordinary temperature, the surfaces of metals such as magnesium, aluminium, zinc, lead, etc., are covered with a thin layer of oxide. The protective oxide layer prevents the metal from further oxidation. Iron does not burn on heating but iron filings burn vigorously when sprinkled in the flame of the burner. Copper does not burn, but the hot metal is coated with a black coloured layer of copper(II) oxide. Silver and gold do not react with oxygen even at high temperatures.

Do You Know?

Anodising is a process of forming a thick oxide layer of aluminium. Aluminium develops a thin oxide layer when exposed to air. This aluminium oxide coat makes it resistant to further corrosion. The resistance can be improved further by making the oxide layer thicker. During anodising, a clean aluminium article is made the anode and is electrolysed with dilute sulphuric acid. The oxygen gas evolved at the anode reacts with aluminium to make a thicker protective oxide layer. This oxide layer can be dyed easily to give aluminium articles an attractive finish.

After performing Activity 3.9, you must have observed that sodium is the most reactive of the samples of metals taken here. The reaction of magnesium is less vigorous implying that it is not as reactive as sodium. But burning in oxygen does not help us to decide about the reactivity of zinc, iron, copper or lead. Let us see some more reactions to arrive at a conclusion about the order of reactivity of these metals.

3.2.2 What happens when Metals react with Water?

Activity 3.10

CAUTION: This Activity needs the teacher's assistance.

- Collect the samples of the same metals as in Activity 3.9.
- Put small pieces of the samples separately in beakers half-filled with cold water.
- Which metals reacted with cold water? Arrange them in the increasing order of their reactivity with cold water.
- Did any metal produce fire on water?
- Does any metal start floating after some time?
- Put the metals that did not react with cold water in beakers half-filled with hot water.
- For the metals that did not react with hot water, arrange the apparatus as shown in Fig. 3.3 and observe their reaction with steam.
- Which metals did not react even with steam?
- Arrange the metals in the decreasing order of reactivity with water.

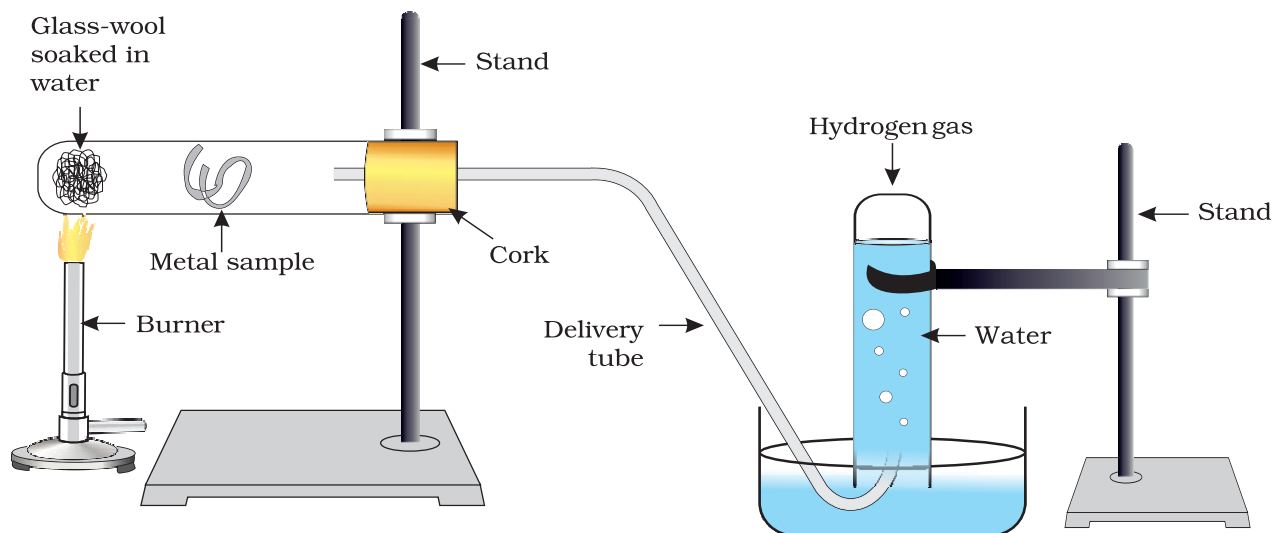
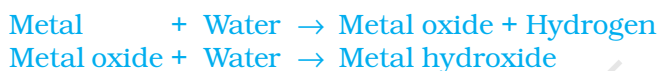
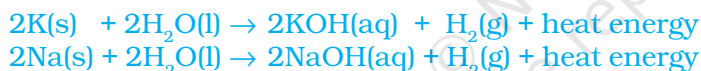

Figure 3.3 Action of steam on a metal

Metals react with water and produce a metal oxide and hydrogen gas. Metal oxides that are soluble in water dissolve in it to further form metal hydroxide. But all metals do not react with water.



Metals like potassium and sodium react violently with cold water. In case of sodium and potassium, the reaction is so violent and exothermic that the evolved hydrogen immediately catches fire.



The reaction of calcium with water is less violent. The heat evolved is not sufficient for the hydrogen to catch fire.



Calcium starts floating because the bubbles of hydrogen gas formed stick to the surface of the metal.

Magnesium does not react with cold water. It reacts with hot water to form magnesium hydroxide and hydrogen. It also starts floating due to the bubbles of hydrogen gas sticking to its surface.

Metals like aluminium, iron and zinc do not react either with cold or hot water. But they react with steam to form the metal oxide and hydrogen.

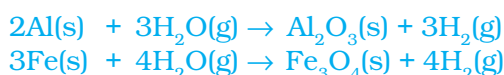

Metals such as lead, copper, silver and gold do not react with water at all.

3.2.3 What happens when Metals react with Acids?

You have already learnt that metals react with acids to give a salt and hydrogen gas.

Metal + Dilute acid → Salt + Hydrogen

But do all metals react in the same manner? Let us find out.

Activity 3.11

- Collect all the metal samples except sodium and potassium again. If the samples are tarnished, rub them clean with sand paper. CAUTION: Do not take sodium and potassium as they react vigorously even with cold water.
- Put the samples separately in test tubes containing dilute hydrochloric acid.
- Suspend thermometers in the test tubes, so that their bulbs are dipped in the acid.
- Observe the rate of formation of bubbles carefully.
- Which metals reacted vigorously with dilute hydrochloric acid?
- With which metal did you record the highest temperature?
- Arrange the metals in the decreasing order of reactivity with dilute acids.

Write equations for the reactions of magnesium, aluminium, zinc and iron with dilute hydrochloric acid.

Hydrogen gas is not evolved when a metal reacts with nitric acid. It is because HNO_3 is a strong oxidising agent. It oxidises the H_2 produced to water and itself gets reduced to any of the nitrogen oxides (N_2O , NO , NO_2). But magnesium (Mg) and manganese (Mn) react with very dilute HNO_3 to evolve H_2 gas.

You must have observed in Activity 3.11, that the rate of formation of bubbles was the fastest in the case of magnesium. The reaction was also the most exothermic in this case. The reactivity decreases in the order $\text{Mg} > \text{Al} > \text{Zn} > \text{Fe}$. In the case of copper, no bubbles were seen and the temperature also remained unchanged. This shows that copper does not react with dilute HCl.

Do You Know?

Aqua regia, (Latin for 'royal water') is a freshly prepared mixture of concentrated hydrochloric acid and concentrated nitric acid in the ratio of 3:1. It can dissolve gold, even though neither of these acids can do so alone. *Aqua regia* is a highly corrosive, fuming liquid. It is one of the few reagents that is able to dissolve gold and platinum.

3.2.4 How do Metals react with Solutions of other Metal Salts?

Activity 3.12

- Take a clean wire of copper and an iron nail.
- Put the copper wire in a solution of iron sulphate and the iron nail in a solution of copper sulphate taken in test tubes (Fig. 3.4).
- Record your observations after 20 minutes.

- In which test tube did you find that a reaction has occurred?
- On what basis can you say that a reaction has actually taken place?
- Can you correlate your observations for the Activities 3.9, 3.10 and 3.11?
- Write a balanced chemical equation for the reaction that has taken place.
- Name the type of reaction.

Reactive metals can displace less reactive metals from their compounds in solution or molten form.

We have seen in the previous sections that all metals are not equally reactive. We checked the reactivity of various metals with oxygen, water and acids. But all metals do not react with these reagents. So we were not able to put all the metal samples we had collected in decreasing order of their reactivity. Displacement reactions studied in Chapter 1 give better evidence about the reactivity of metals. It is simple and easy if metal A displaces metal B from its solution, it is more reactive than B.



Which metal, copper or iron, is more reactive according to your observations in Activity 3.12?

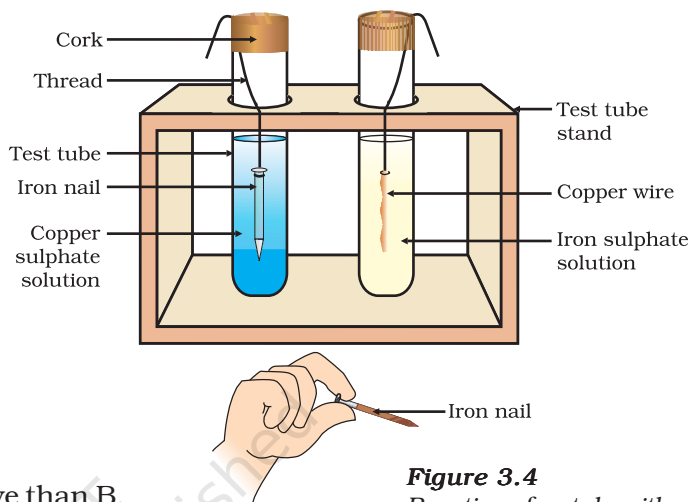

Figure 3.4
Reaction of metals with salt solutions

3.2.5 The Reactivity Series

The reactivity series is a list of metals arranged in the order of their decreasing activities. After performing displacement experiments (Activities 1.9 and 3.12), the following series, (Table 3.2) known as the reactivity or activity series has been developed.

Table 3.2 Activity series : Relative reactivities of metals

K	Potassium	↓	Most reactive
Na	Sodium		
Ca	Calcium		
Mg	Magnesium		
Al	Aluminium		
Zn	Zinc		Reactivity decreases
Fe	Iron		
Pb	Lead		
[H]	[Hydrogen]		
Cu	Copper		
Hg	Mercury		
Ag	Silver		
Au	Gold		Least reactive

Q U E S T I O N S

1. Why is sodium kept immersed in kerosene oil?
2. Write equations for the reactions of
 - (i) iron with steam
 - (ii) calcium and potassium with water
3. Samples of four metals A, B, C and D were taken and added to the following solution one by one. The results obtained have been tabulated as follows.



Metal	Iron(II) sulphate	Copper(II) sulphate	Zinc sulphate	Silver nitrate
A	No reaction	Displacement		
B	Displacement		No reaction	
C	No reaction	No reaction	No reaction	Displacement
D	No reaction	No reaction	No reaction	No reaction

Use the Table above to answer the following questions about metals A, B, C and D.

- (i) Which is the most reactive metal?
 - (ii) What would you observe if B is added to a solution of Copper(II) sulphate?
 - (iii) Arrange the metals A, B, C and D in the order of decreasing reactivity.
4. Which gas is produced when dilute hydrochloric acid is added to a reactive metal? Write the chemical reaction when iron reacts with dilute H_2SO_4 .
 5. What would you observe when zinc is added to a solution of iron(II) sulphate? Write the chemical reaction that takes place.

3.3 HOW DO METALS AND NON-METALS REACT?

In the above activities, you saw the reactions of metals with a number of reagents. Why do metals react in this manner? Let us recall what we learnt about the electronic configuration of elements in Class IX. We learnt that noble gases, which have a completely filled valence shell, show little chemical activity. We, therefore, explain the reactivity of elements as a tendency to attain a completely filled valence shell.

Let us have a look at the electronic configuration of noble gases and some metals and non-metals.

We can see from Table 3.3 that a sodium atom has one electron in its outermost shell. If it loses the electron from its M shell then its L shell now becomes the outermost shell and that has a stable octet. The nucleus of this atom still has 11 protons but the number of electrons has become 10, so there is a net positive charge giving us a sodium cation Na^+ . On the other hand chlorine has seven electrons in its outermost shell

Table 3.3 Electronic configurations of some elements

Type of element	Element	Atomic number	Number of electrons in shells			
			K	L	M	N
Noble gases	Helium (He)	2	2			
	Neon (Ne)	10	2	8		
	Argon (Ar)	18	2	8	8	
Metals	Sodium (Na)	11	2	8	1	
	Magnesium (Mg)	12	2	8	2	
	Aluminium (Al)	13	2	8	3	
	Potassium (K)	19	2	8	8	1
	Calcium (Ca)	20	2	8	8	2
Non-metals	Nitrogen (N)	7	2	5		
	Oxygen (O)	8	2	6		
	Fluorine (F)	9	2	7		
	Phosphorus (P)	15	2	8	5	
	Sulphur (S)	16	2	8	6	
	Chlorine (Cl)	17	2	8	7	

and it requires one more electron to complete its octet. If sodium and chlorine were to react, the electron lost by sodium could be taken up by chlorine. After gaining an electron, the chlorine atom gets a unit negative charge, because its nucleus has 17 protons and there are 18 electrons in its K, L and M shells. This gives us a chloride anion Cl^- . So both these elements can have a give-and-take relation between them as follows (Fig. 3.5).

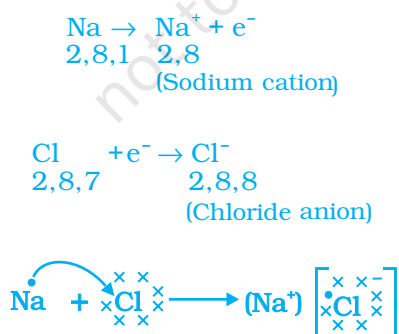
**Figure 3.5** Formation of sodium chloride

Sodium and chloride ions, being oppositely charged, attract each other and are held by strong electrostatic forces of attraction to exist as sodium chloride (NaCl). It should be noted that sodium chloride does not exist as molecules but aggregates of oppositely charged ions.

Let us see the formation of one more ionic compound, magnesium chloride (Fig. 3.6).

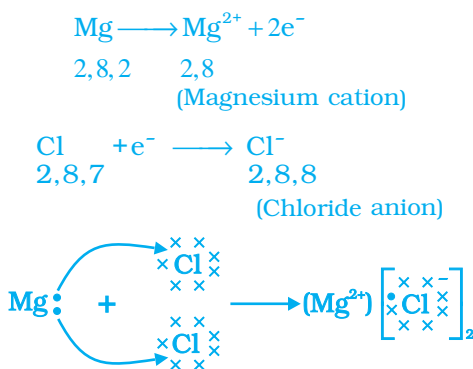

Figure 3.6 Formation of magnesium chloride

The compounds formed in this manner by the transfer of electrons from a metal to a non-metal are known as ionic compounds or electrovalent compounds. Can you name the cation and anion present in MgCl_2 ?

3.3.1 Properties of Ionic Compounds

To learn about the properties of ionic compounds, let us perform the following Activity:

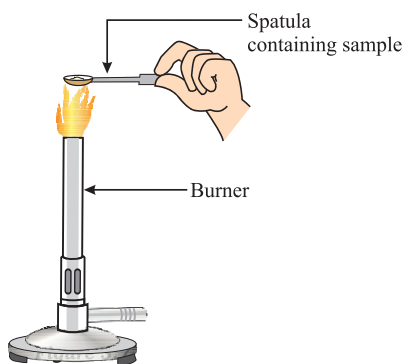

Figure 3.7
Heating a salt sample on a spatula

Activity 3.13

- Take samples of sodium chloride, potassium iodide, barium chloride or any other salt from the science laboratory.
- What is the physical state of these salts?
- Take a small amount of a sample on a metal spatula and heat directly on the flame (Fig. 3.7). Repeat with other samples.
- What did you observe? Did the samples impart any colour to the flame? Do these compounds melt?
- Try to dissolve the samples in water, petrol and kerosene. Are they soluble?
- Make a circuit as shown in Fig. 3.8 and insert the electrodes into a solution of one salt. What did you observe? Test the other salt samples too in this manner.
- What is your inference about the nature of these compounds?

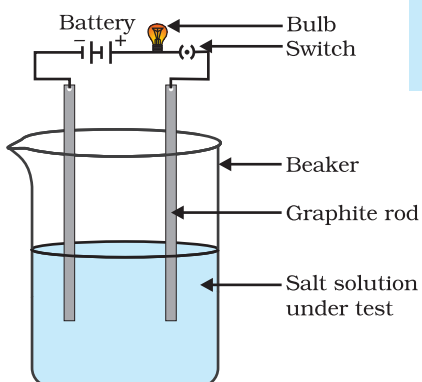

Figure 3.8
Testing the conductivity of a salt solution

Table 3.4 Melting and boiling points of some ionic compounds

Ionic compound	Melting point (K)	Boiling point (K)
NaCl	1074	1686
LiCl	887	1600
CaCl_2	1045	1900
CaO	2850	3120
MgCl_2	981	1685

You may have observed the following general properties for ionic compounds—

- (i) *Physical nature*: Ionic compounds are solids and are somewhat hard because of the strong force of attraction between the positive and negative ions. These compounds are generally brittle and break into pieces when pressure is applied.
- (ii) *Melting and Boiling points*: Ionic compounds have high melting and boiling points (see Table 3.4). This is because a considerable amount of energy is required to break the strong inter-ionic attraction.
- (iii) *Solubility*: Electrovalent compounds are generally soluble in water and insoluble in solvents such as kerosene, petrol, etc.
- (iv) *Conduction of Electricity*: The conduction of electricity through a solution involves the movement of charged particles. A solution of an ionic compound in water contains ions, which move to the opposite electrodes when electricity is passed through the solution. Ionic compounds in the solid state do not conduct electricity because movement of ions in the solid is not possible due to their rigid structure. But ionic compounds conduct electricity in the molten state. This is possible in the molten state since the electrostatic forces of attraction between the oppositely charged ions are overcome due to the heat. Thus, the ions move freely and conduct electricity.

Q U E S T I O N S

1.
 - (i) Write the electron-dot structures for sodium, oxygen and magnesium.
 - (ii) Show the formation of Na_2O and MgO by the transfer of electrons.
 - (iii) What are the ions present in these compounds?
2. Why do ionic compounds have high melting points?



3.4 OCCURRENCE OF METALS

The earth's crust is the major source of metals. Seawater also contains some soluble salts such as sodium chloride, magnesium chloride, etc. The elements or compounds, which occur naturally in the earth's crust, are known as minerals. At some places, minerals contain a very high percentage of a particular metal and the metal can be profitably extracted from it. These minerals are called ores.

3.4.1 Extraction of Metals

You have learnt about the reactivity series of metals. Having this knowledge, you can easily understand how a metal is extracted from its ore. Some metals are found in the earth's crust in the free state. Some are found in the form of their compounds. The metals at the bottom of the activity series are the least reactive. They are often found in a free

K	Electrolysis
Na	
Ca	
Mg	
Al	
Zn	Reduction using carbon
Fe	
Pb	
Cu	
Ag	Found in native state
Au	

state. For example, gold, silver, platinum and copper are found in the free state. Copper and silver are also found in the combined state as their sulphide or oxide ores. The metals at the top of the activity series (K, Na, Ca, Mg and Al) are so reactive that they are never found in nature as free elements. The metals in the middle of the activity series (Zn, Fe, Pb, etc.) are moderately reactive. They are found in the earth's crust mainly as oxides, sulphides or carbonates. You will find that the ores of many metals are oxides. This is because oxygen is a very reactive element and is very abundant on the earth.

Thus on the basis of reactivity, we can group the metals into the following three categories (Fig. 3.9) – (i) Metals of low reactivity; (ii) Metals of medium reactivity; (iii) Metals of high reactivity. Different techniques are to be used for obtaining the metals falling in each category.

Several steps are involved in the extraction of pure metal from ores. A summary of these steps is given in Fig.3.10. Each step is explained in detail in the following sections.

Figure 3.9
Activity series and related metallurgy

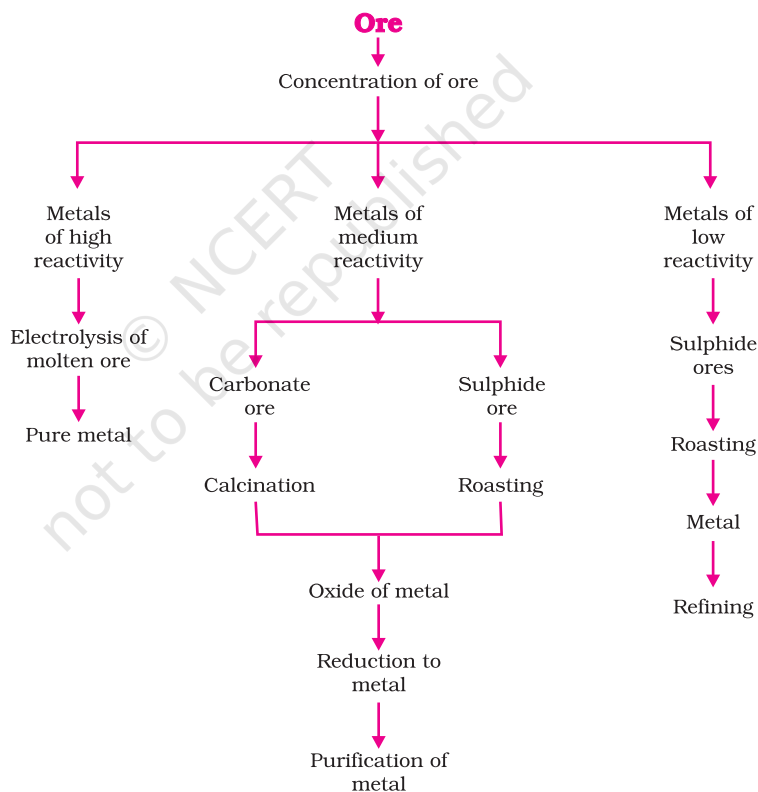

Figure 3.10 Steps involved in the extraction of metals from ores

3.4.2 Enrichment of Ores

Ores mined from the earth are usually contaminated with large amounts of impurities such as soil, sand, etc., called gangue. The impurities must be removed from the ore prior to the extraction of the metal. The processes

used for removing the gangue from the ore are based on the differences between the physical or chemical properties of the gangue and the ore. Different separation techniques are accordingly employed.

3.4.3 Extracting Metals Low in the Activity Series

Metals low in the activity series are very unreactive. The oxides of these metals can be reduced to metals by heating alone. For example, cinnabar (HgS) is an ore of mercury. When it is heated in air, it is first converted into mercuric oxide (HgO). Mercuric oxide is then reduced to mercury on further heating.



Similarly, copper which is found as Cu_2S in nature can be obtained from its ore by just heating in air.



3.4.4 Extracting Metals in the Middle of the Activity Series

The metals in the middle of the activity series such as iron, zinc, lead, copper, are moderately reactive. These are usually present as sulphides or carbonates in nature. It is easier to obtain a metal from its oxide, as compared to its sulphides and carbonates. Therefore, prior to reduction, the metal sulphides and carbonates must be converted into metal oxides. The sulphide ores are converted into oxides by heating strongly in the presence of excess air. This process is known as roasting. The carbonate ores are changed into oxides by heating strongly in limited air. This process is known as calcination. The chemical reaction that takes place during roasting and calcination of zinc ores can be shown as follows –

Roasting



Calcination



The metal oxides are then reduced to the corresponding metals by using suitable reducing agents such as carbon. For example, when zinc oxide is heated with carbon, it is reduced to metallic zinc.



You are already familiar with the process of oxidation and reduction explained in the first Chapter. Obtaining metals from their compounds is also a reduction process.

Besides using carbon (coke) to reduce metal oxides to metals, sometimes displacement reactions can also be used. The highly reactive metals such as sodium, calcium, aluminium, etc., are used as reducing

agents because they can displace metals of lower reactivity from their compounds. For example, when manganese dioxide is heated with aluminium powder, the following reaction takes place –

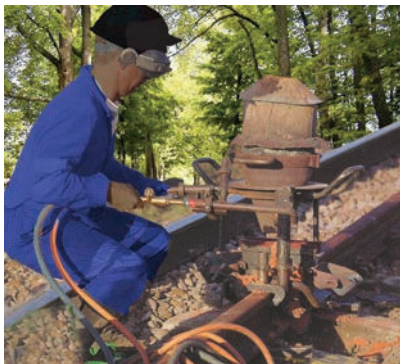

Figure 3.11
Thermit process for joining railway tracks

Can you identify the substances that are getting oxidised and reduced?

These displacement reactions are highly exothermic. The amount of heat evolved is so large that the metals are produced in the molten state. In fact, the reaction of iron(III) oxide (Fe_2O_3) with aluminium is used to join railway tracks or cracked machine parts. This reaction is known as the thermit reaction.



3.4.5 Extracting Metals towards the Top of the Activity Series

The metals high up in the reactivity series are very reactive. They cannot be obtained from their compounds by heating with carbon. For example, carbon cannot reduce the oxides of sodium, magnesium, calcium, aluminium, etc., to the respective metals. This is because these metals have more affinity for oxygen than carbon. These metals are obtained by electrolytic reduction. For example, sodium, magnesium and calcium are obtained by the electrolysis of their molten chlorides. The metals are deposited at the cathode (the negatively charged electrode), whereas, chlorine is liberated at the anode (the positively charged electrode). The reactions are –



Similarly, aluminium is obtained by the electrolytic reduction of aluminium oxide.

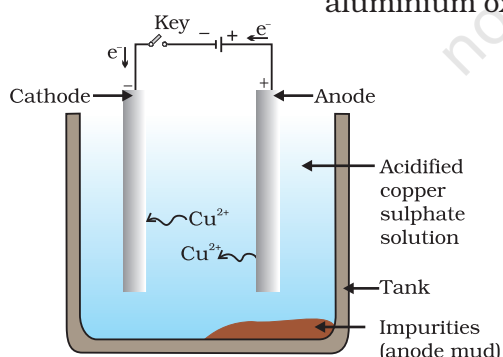

Figure 3.12
Electrolytic refining of copper. The electrolyte is a solution of acidified copper sulphate. The anode is impure copper, whereas, the cathode is a strip of pure copper. On passing electric current, pure copper is deposited on the cathode.

3.4.6 Refining of Metals

The metals produced by various reduction processes described above are not very pure. They contain impurities, which must be removed to obtain pure metals. The most widely used method for refining impure metals is electrolytic refining.

Electrolytic Refining: Many metals, such as copper, zinc, tin, nickel, silver, gold, etc., are refined electrolytically. In this process, the impure metal is made the anode and a thin strip of pure metal is made the cathode. A solution of the metal salt is used as an electrolyte. The apparatus is set up as shown in Fig. 3.12. On passing the current through the electrolyte, the pure metal from the anode dissolves into the electrolyte. An equivalent amount of pure

metal from the electrolyte is deposited on the cathode. The soluble impurities go into the solution, whereas, the insoluble impurities settle down at the bottom of the anode and are known as anode mud.

Q U E S T I O N S

1. Define the following terms.
 - (i) Mineral
 - (ii) Ore
 - (iii) Gangue
2. Name two metals which are found in nature in the free state.
3. What chemical process is used for obtaining a metal from its oxide?



3.5 CORROSION

You have learnt the following about corrosion in Chapter 1 –

- Silver articles become black after some time when exposed to air. This is because it reacts with sulphur in the air to form a coating of silver sulphide.
- Copper reacts with moist carbon dioxide in the air and slowly loses its shiny brown surface and gains a green coat. This green substance is basic copper carbonate.
- Iron when exposed to moist air for a long time acquires a coating of a brown flaky substance called rust.

Let us find out the conditions under which iron rusts.

Activity 3.14

- Take three test tubes and place clean iron nails in each of them.
- Label these test tubes A, B and C. Pour some water in test tube A and cork it.
- Pour boiled distilled water in test tube B, add about 1 mL of oil and cork it. The oil will float on water and prevent the air from dissolving in the water.
- Put some anhydrous calcium chloride in test tube C and cork it. Anhydrous calcium chloride will absorb the moisture, if any, from the air. Leave these test tubes for a few days and then observe (Fig. 3.13).

You will observe that iron nails rust in test tube A, but they do not rust in test tubes B and C. In the test tube A, the nails are exposed to both air and water. In the test tube B, the nails are exposed to only water, and the nails in test tube C are exposed to dry air. What does this tell us about the conditions under which iron articles rust?

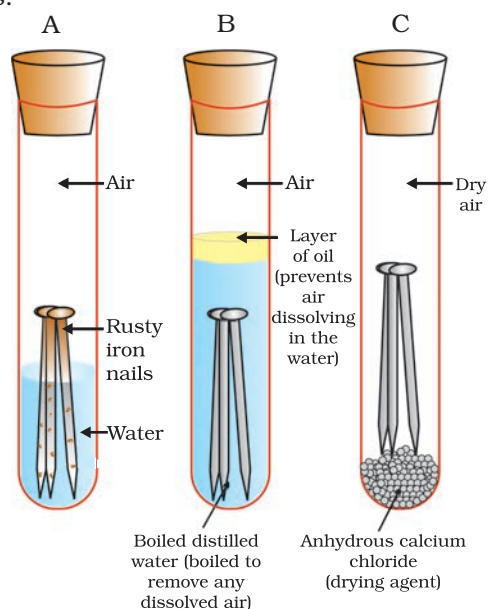

Figure 3.13

Investigating the conditions under which iron rusts. In tube A, both air and water are present. In tube B, there is no air dissolved in the water. In tube C, the air is dry.

3.5.1 Prevention of Corrosion

The rusting of iron can be prevented by painting, oiling, greasing, galvanising, chrome plating, anodising or making alloys.

Galvanisation is a method of protecting steel and iron from rusting by coating them with a thin layer of zinc. The galvanised article is protected against rusting even if the zinc coating is broken. Can you reason this out?

Alloying is a very good method of improving the properties of a metal. We can get the desired properties by this method. For example, iron is the most widely used metal. But it is never used in its pure state. This is because pure iron is very soft and stretches easily when hot. But, if it is mixed with a small amount of carbon (about 0.05 %), it becomes hard and strong. When iron is mixed with nickel and chromium, we get stainless steel, which is hard and does not rust. Thus, if iron is mixed with some other substance, its properties change. In fact, the properties of any metal can be changed if it is mixed with some other substance. The substance added may be a metal or a non-metal. An alloy is a homogeneous mixture of two or more metals, or a metal and a non-metal. It is prepared by first melting the primary metal, and then, dissolving the other elements in it in definite proportions. It is then cooled to room temperature.

Do You Know?

Pure gold, known as 24 carat gold, is very soft. It is, therefore, not suitable for making jewellery. It is alloyed with either silver or copper to make it hard. Generally, in India, 22 carat gold is used for making ornaments. It means that 22 parts of pure gold is alloyed with 2 parts of either copper or silver.

If one of the metals is mercury, then the alloy is known as an amalgam. The electrical conductivity and melting point of an alloy is less than that of pure metals. For example, brass, an alloy of copper and zinc (Cu and Zn), and bronze, an alloy of copper and tin (Cu and Sn), are not good conductors of electricity whereas copper is used for making electrical circuits. Solder, an alloy of lead and tin (Pb and Sn), has a low melting point and is used for welding electrical wires together.



Iron pillar at Delhi

More to Know!

The wonder of ancient Indian metallurgy

The iron pillar near the Qutub Minar in Delhi was built more than 1600 years ago by the iron workers of India. They had developed a process which prevented iron from rusting. For its quality of rust resistance it has been examined by scientists from all parts of the world. The iron pillar is 8 m high and weighs 6 tonnes (6000 kg).

Q U E S T I O N S

1. Metallic oxides of zinc, magnesium and copper were heated with the following metals.

Metal	Zinc	Magnesium	Copper
Zinc oxide			
Magnesium oxide			
Copper oxide			



In which cases will you find displacement reactions taking place?

2. Which metals do not corrode easily?
3. What are alloys?

What you have learnt

- Elements can be classified as metals and non-metals.
- Metals are lustrous, malleable, ductile and are good conductors of heat and electricity. They are solids at room temperature, except mercury which is a liquid.
- Metals can form positive ions by losing electrons to non-metals.
- Metals combine with oxygen to form basic oxides. Aluminium oxide and zinc oxide show the properties of both basic as well as acidic oxides. These oxides are known as amphoteric oxides.
- Different metals have different reactivities with water and dilute acids.
- A list of common metals arranged in order of their decreasing reactivity is known as an activity series.
- Metals above hydrogen in the Activity series can displace hydrogen from dilute acids.
- A more reactive metal displaces a less reactive metal from its salt solution.
- Metals occur in nature as free elements or in the form of their compounds.
- The extraction of metals from their ores and then refining them for use is known as metallurgy.
- An alloy is a homogeneous mixture of two or more metals, or a metal and a non-metal.
- The surface of some metals, such as iron, is corroded when they are exposed to moist air for a long period of time. This phenomenon is known as corrosion.
- Non-metals have properties opposite to that of metals. They are neither malleable nor ductile. They are bad conductors of heat and electricity, except for graphite, which conducts electricity.

- Non-metals form negatively charged ions by gaining electrons when reacting with metals.
- Non-metals form oxides which are either acidic or neutral.
- Non-metals do not displace hydrogen from dilute acids. They react with hydrogen to form hydrides.

E X E R C I S E S

1. Which of the following pairs will give displacement reactions?
 - (a) NaCl solution and copper metal
 - (b) MgCl_2 solution and aluminium metal
 - (c) FeSO_4 solution and silver metal
 - (d) AgNO_3 solution and copper metal.
2. Which of the following methods is suitable for preventing an iron frying pan from rusting?
 - (a) Applying grease
 - (b) Applying paint
 - (c) Applying a coating of zinc
 - (d) All of the above.
3. An element reacts with oxygen to give a compound with a high melting point. This compound is also soluble in water. The element is likely to be
 - (a) calcium
 - (b) carbon
 - (c) silicon
 - (d) iron.
4. Food cans are coated with tin and not with zinc because
 - (a) zinc is costlier than tin.
 - (b) zinc has a higher melting point than tin.
 - (c) zinc is more reactive than tin.
 - (d) zinc is less reactive than tin.
5. You are given a hammer, a battery, a bulb, wires and a switch.
 - (a) How could you use them to distinguish between samples of metals and non-metals?
 - (b) Assess the usefulness of these tests in distinguishing between metals and non-metals.
6. What are amphoteric oxides? Give two examples of amphoteric oxides.
7. Name two metals which will displace hydrogen from dilute acids, and two metals which will not.

8. In the electrolytic refining of a metal M, what would you take as the anode, the cathode and the electrolyte?
9. Pratyush took sulphur powder on a spatula and heated it. He collected the gas evolved by inverting a test tube over it, as shown in figure below.
 - (a) What will be the action of gas on
 - (i) dry litmus paper?
 - (ii) moist litmus paper?
 - (b) Write a balanced chemical equation for the reaction taking place.
10. State two ways to prevent the rusting of iron.
11. What type of oxides are formed when non-metals combine with oxygen?
12. Give reasons
 - (a) Platinum, gold and silver are used to make jewellery.
 - (b) Sodium, potassium and lithium are stored under oil.
 - (c) Aluminium is a highly reactive metal, yet it is used to make utensils for cooking.
 - (d) Carbonate and sulphide ores are usually converted into oxides during the process of extraction.
13. You must have seen tarnished copper vessels being cleaned with lemon or tamarind juice. Explain why these sour substances are effective in cleaning the vessels.
14. Differentiate between metal and non-metal on the basis of their chemical properties.
15. A man went door to door posing as a goldsmith. He promised to bring back the glitter of old and dull gold ornaments. An unsuspecting lady gave a set of gold bangles to him which he dipped in a particular solution. The bangles sparkled like new but their weight was reduced drastically. The lady was upset but after a futile argument the man beat a hasty retreat. Can you play the detective to find out the nature of the solution he had used?
16. Give reasons why copper is used to make hot water tanks and not steel (an alloy of iron).

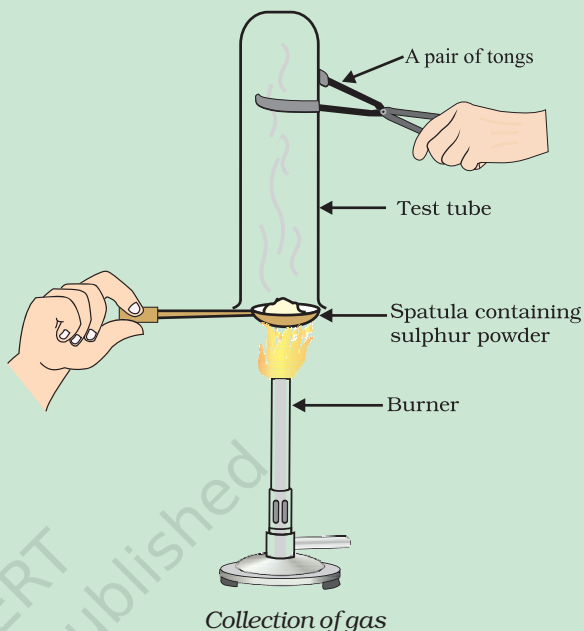



1064CH04

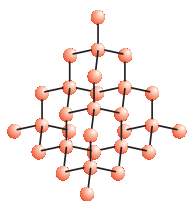

CHAPTER 4

Carbon and its Compounds

In the last Chapter, we came to know many compounds of importance to us. In this Chapter we will study about some more interesting compounds and their properties. Also, we shall be learning about carbon, an element which is of immense significance to us in both its elemental form and in the combined form.

Activity 4.1

- Make a list of ten things you have used or consumed since the morning.
- Compile this list with the lists made by your classmates and then sort the items into the adjacent Table.
- If there are items which are made up of more than one material, put them into both the relevant columns of the table.

Things made of metal	Things made of glass/clay	Others

Look at the items that come in the last column of the above table filled by you – your teacher will be able to tell you that most of them are made up of compounds of carbon. Can you think of a method to test this? What would be the product if a compound containing carbon is burnt? Do you know of any test to confirm this?

Food, clothes, medicines, books, or many of the things that you listed are all based on this versatile element carbon. In addition, all living structures are carbon based. The amount of carbon present in the earth's crust and in the atmosphere is quite meagre. The earth's crust has only 0.02% carbon in the form of minerals (like carbonates, hydrogen-carbonates, coal and petroleum) and the atmosphere has 0.03% of carbon dioxide. In spite of this small amount of carbon available in nature, the importance of carbon seems to be immense. In this Chapter, we will know about the properties of carbon which make carbon so important to us.

4.1 BONDING IN CARBON – THE COVALENT BOND

In the previous Chapter, we have studied the properties of ionic compounds. We saw that ionic compounds have high melting and boiling points and conduct electricity in solution or in the molten state. We also

saw how the nature of bonding in ionic compounds explains these properties. Let us now study the properties of some carbon compounds.

Most carbon compounds are poor conductors of electricity as we have seen in Chapter 2. From the data given in Table 4.1 on the boiling and melting points of the carbon compounds, we find that these compounds have low melting and boiling points as compared to ionic compounds (Chapter 3). We can conclude that the forces of attraction between the molecules are not very strong. Since these compounds are largely non-conductors of electricity, we can conclude that the bonding in these compounds does not give rise to any ions.

In Class IX, we learnt about the combining capacity of various elements and how it depends on the number of valence electrons. Let us now look at the electronic configuration of carbon. The atomic number of carbon is 6. What would be the distribution of electrons in various shells of carbon? How many valence electrons will carbon have?

We know that the reactivity of elements is explained as their tendency to attain a completely filled outer shell, that is, attain noble gas configuration. Elements forming ionic compounds achieve this by either gaining or losing electrons from the outermost shell. In the case of carbon, it has four electrons in its outermost shell and needs to gain or lose four electrons to attain noble gas configuration. If it were to gain or lose electrons –

- (i) It could gain four electrons forming C^{4-} anion. But it would be difficult for the nucleus with six protons to hold on to ten electrons, that is, four extra electrons.
- (ii) It could lose four electrons forming C^{4+} cation. But it would require a large amount of energy to remove four electrons leaving behind a carbon cation with six protons in its nucleus holding on to just two electrons.

Carbon overcomes this problem by sharing its valence electrons with other atoms of carbon or with atoms of other elements. Not just carbon, but many other elements form molecules by sharing electrons in this manner. The shared electrons 'belong' to the outermost shells of both the atoms and lead to both atoms attaining the noble gas configuration. Before going on to compounds of carbon, let us look at some simple molecules formed by the sharing of valence electrons.

The simplest molecule formed in this manner is that of hydrogen. As you have learnt earlier, the atomic number of hydrogen is 1. Hence hydrogen has one electron in its K shell and it requires one more electron to fill the K shell. So two hydrogen atoms share their electrons to form a molecule of hydrogen, H_2 . This allows each hydrogen atom to attain the

Table 4.1 Melting points and boiling points of some compounds of carbon

Compound	Melting point (K)	Boiling point (K)
Acetic acid (CH_3COOH)	290	391
Chloroform ($CHCl_3$)	209	334
Ethanol (CH_3CH_2OH)	156	351
Methane (CH_4)	90	111

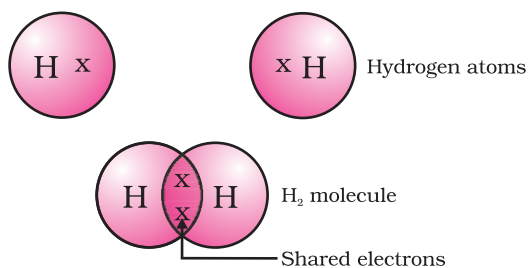

Figure 4.1
A molecule of hydrogen

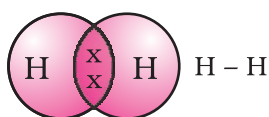

Figure 4.2
Single bond between two hydrogen atoms

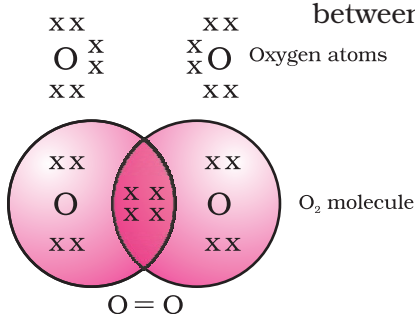

Figure 4.3
Double bond between two oxygen atoms

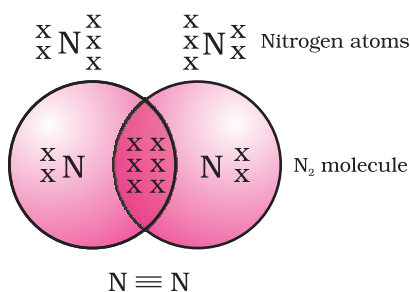

Figure 4.4
Triple bond between two nitrogen atoms

electronic configuration of the nearest noble gas, helium, which has two electrons in its K shell. We can depict this using dots or crosses to represent valence electrons (Fig. 4.1).

The shared pair of electrons is said to constitute a single covalent bond between the two hydrogen atoms. A single covalent bond is also represented by a line between the two atoms, as shown in Fig. 4.2.

The atomic number of chlorine is 17. What would be its electronic configuration and its valency? Chlorine forms a diatomic molecule, Cl_2 . Can you draw the electron dot structure for this molecule? Note that only the valence shell electrons need to be depicted.

In the case of oxygen, we see the formation of a double bond between two oxygen atoms. This is because an atom of oxygen has six electrons in its L shell (the atomic number of oxygen is eight) and it requires two more electrons to complete its octet. So each atom of oxygen shares two electrons with another atom of oxygen to give us the structure shown in Fig. 4.3. The two electrons contributed by each oxygen atom give rise to two shared pairs of electrons. This is said to constitute a double bond between the two atoms.

Can you now depict a molecule of water showing the nature of bonding between one oxygen atom and two hydrogen atoms? Does the molecule have single bonds or double bonds?

What would happen in the case of a diatomic molecule of nitrogen? Nitrogen has the atomic number 7. What would be its electronic configuration and its combining capacity? In order to attain an octet, each nitrogen atom in a molecule of nitrogen contributes three electrons giving rise to three shared pairs of electrons. This is said to constitute a triple bond between the two atoms. The electron dot structure of N_2 and its triple bond can be depicted as in Fig. 4.4.

A molecule of ammonia has the formula NH_3 . Can you draw the electron dot structure for this molecule showing how all four atoms achieve noble gas configuration? Will the molecule have single, double or triple bonds?

Let us now take a look at methane, which is a compound of carbon. Methane is widely used as a fuel and is a major component of bio-gas and Compressed Natural Gas (CNG). It is also one of the simplest compounds formed by carbon. Methane has a formula CH_4 . Hydrogen, as you know, has a valency of 1. Carbon is tetravalent because it has four valence electrons. In order to achieve noble gas configuration, carbon shares these electrons with four atoms of hydrogen as shown in Fig. 4.5.

Such bonds which are formed by the sharing of an electron pair between two atoms are known as covalent bonds. Covalently bonded molecules are seen to have strong bonds within the molecule, but inter-molecular forces are weak. This gives rise to the low melting and boiling

points of these compounds. Since the electrons are shared between atoms and no charged particles are formed, such covalent compounds are generally poor conductors of electricity.

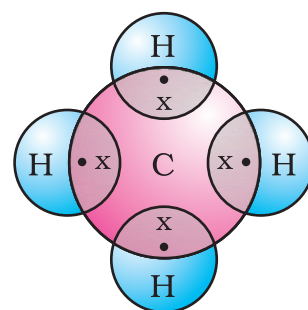
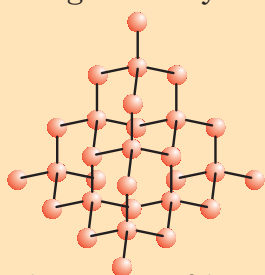

Figure 4.5
Electron dot structure for methane

Allotropes of carbon

The element carbon occurs in different forms in nature with widely varying physical properties. Both diamond and graphite are formed by carbon atoms, the difference lies in the manner in which the carbon atoms are bonded to one another. In diamond, each carbon atom is bonded to four other carbon atoms forming a rigid three-dimensional structure. In graphite, each carbon atom is bonded to three other carbon atoms in the same plane giving a hexagonal array. One of these bonds is a double-bond, and thus the valency of carbon is satisfied. Graphite structure is formed by the hexagonal arrays being placed in layers one above the other.



The structure of diamond

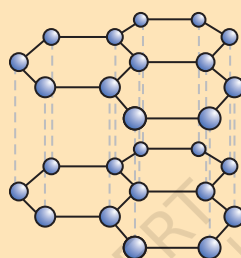

The structure of graphite

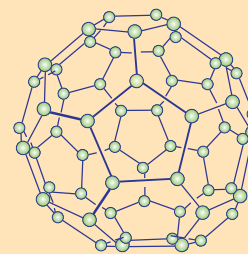
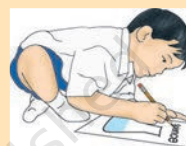

The structure of C-60 Buckminsterfullerene

These two different structures result in diamond and graphite having very different physical properties even though their chemical properties are the same. Diamond is the hardest substance known while graphite is smooth and slippery. Graphite is also a very good conductor of electricity unlike other non-metals that you studied in the previous Chapter.

Diamonds can be synthesised by subjecting pure carbon to very high pressure and temperature. These synthetic diamonds are small but are otherwise indistinguishable from natural diamonds.

Fullerenes form another class of carbon allotropes. The first one to be identified was C-60 which has carbon atoms arranged in the shape of a football. Since this looked like the geodesic dome designed by the US architect Buckminster Fuller, the molecule was named fullerene.

More to Know!

Q U E S T I O N S

1. What would be the electron dot structure of carbon dioxide which has the formula CO_2 ?
2. What would be the electron dot structure of a molecule of sulphur which is made up of eight atoms of sulphur? (**Hint** – The eight atoms of sulphur are joined together in the form of a ring.)



4.2 VERSATILE NATURE OF CARBON

We have seen the formation of covalent bonds by the sharing of electrons in various elements and compounds. We have also seen the structure of a simple carbon compound, methane. In the beginning of the Chapter, we saw how many things we use contain carbon. In fact, we ourselves are made up of carbon compounds. The numbers of carbon compounds whose formulae are known to chemists was recently estimated to be in millions! This outnumbers by a large margin the compounds formed by all the other elements put together. Why is it that this property is seen in carbon and no other element? The nature of the covalent bond enables carbon to form a large number of compounds. Two factors noticed in the case of carbon are –

- (i) Carbon has the unique ability to form bonds with other atoms of carbon, giving rise to large molecules. This property is called catenation. These compounds may have long chains of carbon, branched chains of carbon or even carbon atoms arranged in rings. In addition, carbon atoms may be linked by single, double or triple bonds. Compounds of carbon, which are linked by only single bonds between the carbon atoms are called saturated compounds. Compounds of carbon having double or triple bonds between their carbon atoms are called unsaturated compounds.

No other element exhibits the property of catenation to the extent seen in carbon compounds. Silicon forms compounds with hydrogen which have chains of upto seven or eight atoms, but these compounds are very reactive. The carbon-carbon bond is very strong and hence stable. This gives us the large number of compounds with many carbon atoms linked to each other.

- (ii) Since carbon has a valency of four, it is capable of bonding with four other atoms of carbon or atoms of some other mono-valent element. Compounds of carbon are formed with oxygen, hydrogen, nitrogen, sulphur, chlorine and many other elements giving rise to compounds with specific properties which depend on the elements other than carbon present in the molecule.

Again the bonds that carbon forms with most other elements are very strong making these compounds exceptionally stable. One reason for the formation of strong bonds by carbon is its small size. This enables the nucleus to hold on to the shared pairs of electrons strongly. The bonds formed by elements having bigger atoms are much weaker.

Organic compounds

The two characteristic features seen in carbon, that is, tetravalency and catenation, put together give rise to a large number of compounds. Many have the same non-carbon atom or group of atoms attached to different carbon chains. These compounds were initially extracted from natural substances and it was thought that these carbon compounds or organic compounds could only be formed within a living system. That is, it was postulated that a 'vital force' was necessary for their synthesis. Friedrich Wöhler disproved this in 1828 by preparing urea from ammonium cyanate. But carbon compounds, except for carbides, oxides of carbon, carbonate and hydrogencarbonate salts continue to be studied under organic chemistry.

4.2.1 Saturated and Unsaturated Carbon Compounds

We have already seen the structure of methane. Another compound formed between carbon and hydrogen is ethane with a formula of C_2H_6 . In order to arrive at the structure of simple carbon compounds, the first step is to link the carbon atoms together with a single bond (Fig. 4.6a) and then use the hydrogen atoms to satisfy the remaining valencies of carbon (Fig. 4.6b). For example, the structure of ethane is arrived in the following steps –



Step 1

Figure 4.6 (a) Carbon atoms linked together with a single bond

Three valencies of each carbon atom remain unsatisfied, so each is bonded to three hydrogen atoms giving:

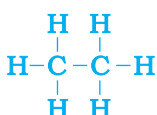

Step 2

Figure 4.6 (b) Each carbon atom bonded to three hydrogen atoms

The electron dot structure of ethane is shown in Fig. 4.6(c).

Can you draw the structure of propane, which has the molecular formula C_3H_8 in a similar manner? You will see that the valencies of all the atoms are satisfied by single bonds between them. Such carbon compounds are called saturated compounds. These compounds are normally not very reactive.

However, another compound of carbon and hydrogen has the formula C_2H_4 and is called ethene. How can this molecule be depicted? We follow the same step-wise approach as above.

Carbon-carbon atoms linked together with a single bond (Step 1).

We see that one valency per carbon atom remains unsatisfied (Step 2). This can be satisfied only if there is a double bond between the two carbons (Step 3).

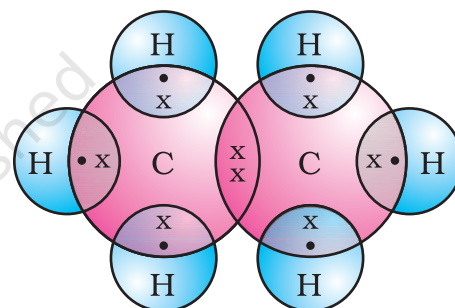
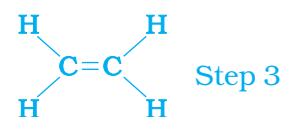
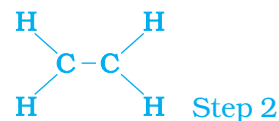

Figure 4.6
(c) Electron dot structure of ethane



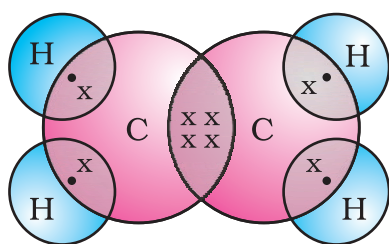

Figure 4.7
Structure of ethene

The electron dot structure for ethene is given in Fig. 4.7. Yet another compound of hydrogen and carbon has the formula C_2H_2 and is called ethyne. Can you draw the electron dot structure for ethyne? How many bonds are necessary between the two carbon atoms in order to satisfy their valencies? Such compounds of carbon having double or triple bonds between the carbon atoms are known as unsaturated carbon compounds and they are more reactive than the saturated carbon compounds.

4.2.2 Chains, Branches and Rings

In the earlier section, we mentioned the carbon compounds methane, ethane and propane, containing respectively 1, 2 and 3 carbon atoms. Such 'chains' of carbon atoms can contain many more carbon atoms. The names and structures of six of these are given in Table 4.2.

Table 4.2 Formulae and structures of saturated compounds of carbon and hydrogen

No. of C atoms	Name	Formula	Structure
1	Methane	CH_4	$\begin{array}{c} H \\ \\ H-C-H \\ \\ H \end{array}$
2	Ethane	C_2H_6	$\begin{array}{c} H & H \\ & \\ H-C & -C-H \\ & \\ H & H \end{array}$
3	Propane	C_3H_8	$\begin{array}{c} H & H & H \\ & & \\ H-C & -C & -C-H \\ & & \\ H & H & H \end{array}$
4	Butane	C_4H_{10}	$\begin{array}{c} H & H & H & H \\ & & & \\ H-C & -C & -C & -C-H \\ & & & \\ H & H & H & H \end{array}$
5	Pentane	C_5H_{12}	$\begin{array}{c} H & H & H & H & H \\ & & & & \\ H-C & -C & -C & -C & -C-H \\ & & & & \\ H & H & H & H & H \end{array}$
6	Hexane	C_6H_{14}	$\begin{array}{c} H & H & H & H & H & H \\ & & & & & \\ H-C & -C & -C & -C & -C & -C-H \\ & & & & & \\ H & H & H & H & H & H \end{array}$

But, let us take another look at butane. If we make the carbon 'skeleton' with four carbon atoms, we see that two different possible 'skeletons' are –

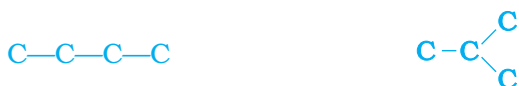

Figure 4.8 (a) Two possible carbon-skeletons

Filling the remaining valencies with hydrogen gives us –

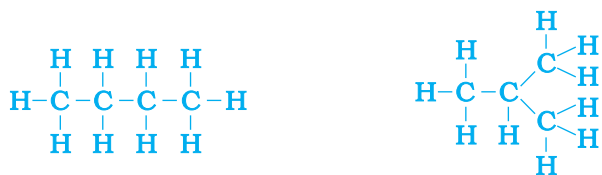

Figure 4.8 (b) Complete molecules for two structures with formula C_4H_{10}

We see that both these structures have the same formula C_4H_{10} . Such compounds with identical molecular formula but different structures are called structural isomers.

In addition to straight and branched carbon chains, some compounds have carbon atoms arranged in the form of a ring. For example, cyclohexane has the formula C_6H_{12} and the following structure –

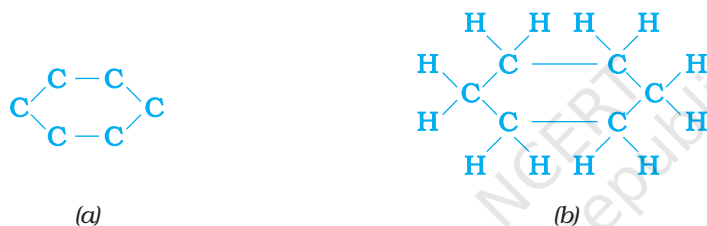

Figure 4.9 Structure of cyclohexane (a) carbon skeleton (b) complete molecule

Can you draw the electron dot structure for cyclohexane? Straight chain, branched chain and cyclic carbon compounds, all may be saturated or unsaturated. For example, benzene, C_6H_6 , has the following structure –

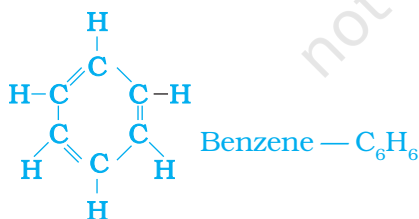

Figure 4.10 Structure of benzene

All these carbon compounds which contain only carbon and hydrogen are called hydrocarbons. Among these, the saturated hydrocarbons are called alkanes. The unsaturated hydrocarbons which contain one or more double bonds are called alkenes. Those containing one or more triple bonds are called alkynes.

4.2.3 Will you be my Friend?

Carbon seems to be a very friendly element. So far we have been looking at compounds containing carbon and hydrogen only. But carbon also forms

bonds with other elements such as halogens, oxygen, nitrogen and sulphur. In a hydrocarbon chain, one or more hydrogens can be replaced by these elements, such that the valency of carbon remains satisfied. In such compounds, the element replacing hydrogen is referred to as a heteroatom. These heteroatoms are also present in some groups as given in Table 4.3.

Table 4.3 Some functional groups in carbon compounds

Hetero atom	Class of compounds	Formula of functional group
Cl/Br	Halo- (Chloro/bromo) alkane	—Cl, —Br (substitutes for hydrogen atom)
Oxygen	1. Alcohol	—OH
	2. Aldehyde	$\begin{array}{c} \text{H} \\ \\ \text{—C—} \\ \\ \text{O} \end{array}$
	3. Ketone	$\begin{array}{c} \text{—C—} \\ \\ \text{O} \end{array}$
	4. Carboxylic acid	$\begin{array}{c} \text{O} \\ \\ \text{—C—OH} \end{array}$

These heteroatoms and the group containing these confer specific properties to the compound, regardless of the length and nature of the carbon chain and hence are called functional groups. Some important functional groups are given in the Table 4.3. Free valency or valencies of the group are shown by the single line. The functional group is attached to the carbon chain through this valency by replacing one hydrogen atom or atoms.

4.2.4 Homologous Series

You have seen that carbon atoms can be linked together to form chains of varying lengths. These chains can be branched also. In addition, hydrogen atom or other atoms on these carbon chains can be replaced by any of the functional groups that we saw above. The presence of a functional group such as alcohol decides the properties of the carbon compound, regardless of the length of the carbon chain. For example, the chemical properties of CH_3OH , $\text{C}_2\text{H}_5\text{OH}$, $\text{C}_3\text{H}_7\text{OH}$ and $\text{C}_4\text{H}_9\text{OH}$ are all very similar. Hence, such a series of compounds in which the same functional group substitutes for hydrogen in a carbon chain is called a homologous series.

Let us look at the homologous series that we saw earlier in Table 4.2. If we look at the formulae of successive compounds, say –

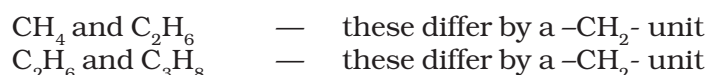

What is the difference between the next pair – propane and butane (C_4H_{10})?

Can you find out the difference in molecular masses between these pairs (the atomic mass of carbon is 12 u and the atomic mass of hydrogen is 1 u)?

Similarly, take the homologous series for alkenes. The first member of the series is ethene which we have already come across in Section 4.2.1. What is the formula for ethene? The succeeding members have the formula C_3H_6 , C_4H_8 and C_5H_{10} . Do these also differ by a $\text{—CH}_2\text{—}$

unit? Do you see any relation between the number of carbon and hydrogen atoms in these compounds? The general formula for alkenes can be written as C_nH_{2n} , where $n = 2, 3, 4$. Can you similarly generate the general formula for alkanes and alkynes?

As the molecular mass increases in any homologous series, a gradation in physical properties is seen. This is because the melting and boiling points increase with increasing molecular mass. Other physical properties such as solubility in a particular solvent also show a similar gradation. But the chemical properties, which are determined solely by the functional group, remain similar in a homologous series.

Activity 4.2

- Calculate the difference in the formulae and molecular masses for (a) CH_3OH and C_2H_5OH (b) C_2H_5OH and C_3H_7OH , and (c) C_3H_7OH and C_4H_9OH .
- Is there any similarity in these three?
- Arrange these alcohols in the order of increasing carbon atoms to get a family. Can we call this family a homologous series?
- Generate the homologous series for compounds containing up to four carbons for the other functional groups given in Table 4.3.

4.2.5 Nomenclature of Carbon Compounds

The names of compounds in a homologous series are based on the name of the basic carbon chain modified by a “prefix” “phrase before” or “suffix” “phrase after” indicating the nature of the functional group. For example, the names of the alcohols taken in Activity 4.2 are methanol, ethanol, propanol and butanol.

Naming a carbon compound can be done by the following method –

- Identify the number of carbon atoms in the compound. A compound having three carbon atoms would have the name propane.
- In case a functional group is present, it is indicated in the name of the compound with either a prefix or a suffix (as given in Table 4.4).
- If the name of the functional group is to be given as a suffix, and the suffix of the functional group begins with a vowel a, e, i, o, u, then the name of the carbon chain is modified by deleting the final ‘e’ and adding the appropriate suffix. For example, a three-carbon chain with a ketone group would be named in the following manner –
Propane – ‘e’ = propan + ‘one’ = propanone.
- If the carbon chain is unsaturated, then the final ‘ane’ in the name of the carbon chain is substituted by ‘ene’ or ‘yne’ as given in Table 4.4. For example, a three-carbon chain with a double bond would be called propene and if it has a triple bond, it would be called propyne.

Table 4.4 Nomenclature of organic compounds

Class of compounds	Prefix/Suffix	Example
1. Halo alkane	Prefix-chloro, bromo, etc.	$\begin{array}{c} \text{H} \quad \text{H} \quad \text{H} \\ \quad \quad \\ \text{H}-\text{C}-\text{C}-\text{C}-\text{Cl} \\ \quad \quad \\ \text{H} \quad \text{H} \quad \text{H} \end{array}$ Chloropropane
		$\begin{array}{c} \text{H} \quad \text{H} \quad \text{H} \\ \quad \quad \\ \text{H}-\text{C}-\text{C}-\text{C}-\text{Br} \\ \quad \quad \\ \text{H} \quad \text{H} \quad \text{H} \end{array}$ Bromopropane
2. Alcohol	Suffix - ol	$\begin{array}{c} \text{H} \quad \text{H} \quad \text{H} \\ \quad \quad \\ \text{H}-\text{C}-\text{C}-\text{C}-\text{OH} \\ \quad \quad \\ \text{H} \quad \text{H} \quad \text{H} \end{array}$ Propanol
3. Aldehyde	Suffix - al	$\begin{array}{c} \text{H} \quad \text{H} \quad \text{H} \\ \quad \quad \\ \text{H}-\text{C}-\text{C}-\text{C}=\text{O} \\ \quad \\ \text{H} \quad \text{H} \end{array}$ Propanal
4. Ketone	Suffix - one	$\begin{array}{c} \text{H} \quad \quad \text{H} \\ \quad \quad \\ \text{H}-\text{C}-\text{C}-\text{C}-\text{H} \\ \quad \quad \\ \text{H} \quad \text{O} \quad \text{H} \end{array}$ Propanone
5. Carboxylic acid	Suffix - oic acid	$\begin{array}{c} \text{H} \quad \text{H} \quad \text{O} \\ \quad \quad \\ \text{H}-\text{C}-\text{C}-\text{C}-\text{OH} \\ \quad \\ \text{H} \quad \text{H} \end{array}$ Propanoic acid
6. Alkenes	Suffix - ene	$\begin{array}{c} \text{H} \quad \text{H} \\ \quad \\ \text{H}-\text{C}-\text{C}=\text{C} \\ \quad \quad \\ \text{H} \quad \quad \text{H} \end{array}$ Propene
7. Alkynes	Suffix - yne	$\begin{array}{c} \text{H} \\ \\ \text{H}-\text{C}-\text{C}\equiv\text{C}-\text{H} \\ \\ \text{H} \end{array}$ Propyne

Q U E S T I O N S

- How many structural isomers can you draw for pentane?
- What are the two properties of carbon which lead to the huge number of carbon compounds we see around us?
- What will be the formula and electron dot structure of cyclopentane?

4. Draw the structures for the following compounds.
- (i) Ethanoic acid (ii) Bromopentane*
- (iii) Butanone (iv) Hexanal.

*Are structural isomers possible for bromopentane?

5. How would you name the following compounds?

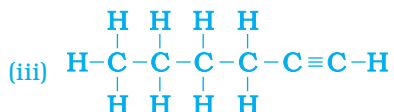

4.3 CHEMICAL PROPERTIES OF CARBON COMPOUNDS

In this section we will be studying about some of the chemical properties of carbon compounds. Since most of the fuels we use are either carbon or its compounds, we shall first study combustion.

4.3.1 Combustion

Carbon, in all its allotropic forms, burns in oxygen to give carbon dioxide along with the release of heat and light. Most carbon compounds also release a large amount of heat and light on burning. These are the oxidation reactions that you learnt about in the first Chapter –

- (i) $\text{C} + \text{O}_2 \rightarrow \text{CO}_2 + \text{heat and light}$
- (ii) $\text{CH}_4 + \text{O}_2 \rightarrow \text{CO}_2 + \text{H}_2\text{O} + \text{heat and light}$
- (iii) $\text{CH}_3\text{CH}_2\text{OH} + \text{O}_2 \rightarrow \text{CO}_2 + \text{H}_2\text{O} + \text{heat and light}$

Balance the latter two reactions like you learnt in the first Chapter.

Activity 4.3

CAUTION: This Activity needs the teacher's assistance.

- Take some carbon compounds (naphthalene, camphor, alcohol) one by one on a spatula and burn them.
- Observe the nature of the flame and note whether smoke is produced.
- Place a metal plate above the flame. Is there a deposition on the plate in case of any of the compounds?

Activity 4.4

- Light a bunsen burner and adjust the air hole at the base to get different types of flames/presence of smoke.
- When do you get a yellow, sooty flame?
- When do you get a blue flame?

Saturated hydrocarbons will generally give a clean flame while unsaturated carbon compounds will give a yellow flame with lots of black smoke. This results in a sooty deposit on the metal plate in Activity 4.3. However, limiting the supply of air results in incomplete combustion of even saturated hydrocarbons giving a sooty flame. The gas/kerosene stove used at home has inlets for air so that a sufficiently oxygen-rich

mixture is burnt to give a clean blue flame. If you observe the bottoms of cooking vessels getting blackened, it means that the air holes are blocked and fuel is getting wasted. Fuels such as coal and petroleum have some amount of nitrogen and sulphur in them. Their combustion results in the formation of oxides of sulphur and nitrogen which are major pollutants in the environment.

Do You Know?

Why do substances burn with or without a flame?

Have you ever observed either a coal or a wood fire? If not, the next time you get a chance, take close note of what happens when the wood or coal starts to burn. You have seen above that a candle or the LPG in the gas stove burns with a flame. However, you will observe the coal or charcoal in an 'angithi' sometimes just glows red and gives out heat without a flame. This is because a flame is only produced when gaseous substances burn. When wood or charcoal is ignited, the volatile substances present vapourise and burn with a flame in the beginning.

A luminous flame is seen when the atoms of the gaseous substance are heated and start to glow. The colour produced by each element is a characteristic property of that element. Try and heat a copper wire in the flame of a gas stove and observe its colour. You have seen that incomplete combustion gives soot which is carbon. On this basis, what will you attribute the yellow colour of a candle flame to?

More to Know!

Formation of coal and petroleum

Coal and petroleum have been formed from biomass which has been subjected to various biological and geological processes. Coal is the remains of trees, ferns, and other plants that lived millions of years ago. These were crushed into the earth, perhaps by earthquakes or volcanic eruptions. They were pressed down by layers of earth and rock. They slowly decayed into coal. Oil and gas are the remains of millions of tiny plants and animals that lived in the sea. When they died, their bodies sank to the sea bed and were covered by silt. Bacteria attacked the dead remains, turning them into oil and gas under the high pressures they were being subjected to. Meanwhile, the silt was slowly compressed into rock. The oil and gas seeped into the porous parts of the rock, and got trapped like water in a sponge. Can you guess why coal and petroleum are called fossil fuels?

4.3.2 Oxidation

Activity 4.5

- Take about 3 mL of ethanol in a test tube and warm it gently in a water bath.
- Add a 5% solution of alkaline potassium permanganate drop by drop to this solution.
- Does the colour of potassium permanganate persist when it is added initially?
- Why does the colour of potassium permanganate not disappear when excess is added?

You have learnt about oxidation reactions in the first Chapter. Carbon compounds can be easily oxidised on combustion. In addition to this complete oxidation, we have reactions in which alcohols are converted to carboxylic acids –



We see that some substances are capable of adding oxygen to others. These substances are known as oxidising agents.

Alkaline potassium permanganate or acidified potassium dichromate are oxidising alcohols to acids, that is, adding oxygen to the starting material. Hence they are known as oxidising agents.

4.3.3 Addition Reaction

Unsaturated hydrocarbons add hydrogen in the presence of catalysts such as palladium or nickel to give saturated hydrocarbons. Catalysts are substances that cause a reaction to occur or proceed at a different rate without the reaction itself being affected. This reaction is commonly used in the hydrogenation of vegetable oils using a nickel catalyst. Vegetable oils generally have long unsaturated carbon chains while animal fats have saturated carbon chains.

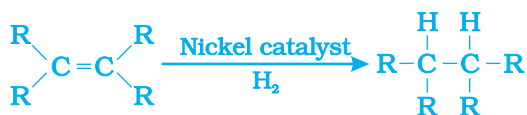

You must have seen advertisements stating that some vegetable oils are 'healthy'. Animal fats generally contain saturated fatty acids which are said to be harmful for health. Oils containing unsaturated fatty acids should be chosen for cooking.

4.3.4 Substitution Reaction

Saturated hydrocarbons are fairly unreactive and are inert in the presence of most reagents. However, in the presence of sunlight, chlorine is added to hydrocarbons in a very fast reaction. Chlorine can replace the hydrogen atoms one by one. It is called a substitution reaction because one type of atom or a group of atoms takes the place of another. A number of products are usually formed with the higher homologues of alkanes.



Q U E S T I O N S

1. Why is the conversion of ethanol to ethanoic acid an oxidation reaction?
2. A mixture of oxygen and ethyne is burnt for welding. Can you tell why a mixture of ethyne and air is not used?



4.4 SOME IMPORTANT CARBON COMPOUNDS – ETHANOL AND ETHANOIC ACID

Many carbon compounds are invaluable to us. But here we shall study the properties of two commercially important compounds – ethanol and ethanoic acid.

4.4.1 Properties of Ethanol

Ethanol is a liquid at room temperature (refer to Table 4.1 for the melting and boiling points of ethanol). Ethanol is commonly called alcohol and is the active ingredient of all alcoholic drinks. In addition, because it is a good solvent, it is also used in medicines such as tincture iodine, cough syrups, and many tonics. Ethanol is also soluble in water in all proportions. Consumption of small quantities of dilute ethanol causes drunkenness. Even though this practice is condemned, it is a socially widespread practice. However, intake of even a small quantity of pure ethanol (called absolute alcohol) can be lethal. Also, long-term consumption of alcohol leads to many health problems.

Reactions of Ethanol

(i) Reaction with sodium –

Activity 4.6

Teacher's demonstration –

- Drop a small piece of sodium, about the size of a couple of grains of rice, into ethanol (absolute alcohol).
- What do you observe?
- How will you test the gas evolved?

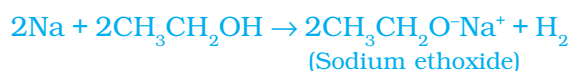

Alcohols react with sodium leading to the evolution of hydrogen. With ethanol, the other product is sodium ethoxide. Can you recall which other substances produce hydrogen on reacting with metals?

(ii) Reaction to give unsaturated hydrocarbon: Heating ethanol at 443 K with excess concentrated sulphuric acid results in the dehydration of ethanol to give ethene –



The concentrated sulphuric acid can be regarded as a dehydrating agent which removes water from ethanol.

Do You Know?

How do alcohols affect living beings?

When large quantities of ethanol are consumed, it tends to slow metabolic processes and to depress the central nervous system. This results in lack of coordination, mental confusion, drowsiness, lowering of the normal inhibitions, and finally stupor. The individual may feel relaxed without realising that his sense of judgement, sense of timing, and muscular coordination have been seriously impaired.

Unlike ethanol, intake of methanol in very small quantities can cause death. Methanol is oxidised to methanal in the liver. Methanal reacts rapidly with the components of cells. It coagulates the protoplasm, in much the same way an egg is coagulated by cooking. Methanol also affects the optic nerve, causing blindness.

Ethanol is an important industrial solvent. To prevent the misuse of ethanol produced for industrial use, it is made unfit for drinking by adding poisonous substances like methanol to it. Dyes are also added to colour the alcohol blue so that it can be identified easily. This is called denatured alcohol.

Alcohol as a fuel

Sugarcane plants are one of the most efficient converters of sunlight into chemical energy. Sugarcane juice can be used to prepare molasses which is fermented to give alcohol (ethanol). Some countries now use alcohol as an additive in petrol since it is a cleaner fuel which gives rise to only carbon dioxide and water on burning in sufficient air (oxygen).

4.4.2 Properties of Ethanoic Acid

Ethanoic acid is commonly called acetic acid and belongs to a group of acids called carboxylic acids. 5-8% solution of acetic acid in water is called vinegar and is used widely as a preservative in pickles. The melting point of pure ethanoic acid is 290 K and hence it often freezes during winter in cold climates. This gave rise to its name glacial acetic acid.

The group of organic compounds called carboxylic acids are obviously characterised by their acidic nature. However, unlike mineral acids like HCl, which are completely ionised, carboxylic acids are weak acids.

Activity 4.8

- Take 1 mL ethanol (absolute alcohol) and 1 mL glacial acetic acid along with a few drops of concentrated sulphuric acid in a test tube.
- Warm in a water-bath for at least five minutes as shown in Fig. 4.11.
- Pour into a beaker containing 20-50 mL of water and smell the resulting mixture.

Reactions of ethanoic acid:

- (i) *Esterification reaction*: Esters are most commonly formed by reaction of an acid and an alcohol. Ethanoic acid reacts with absolute ethanol in the presence of an acid catalyst to give an ester –

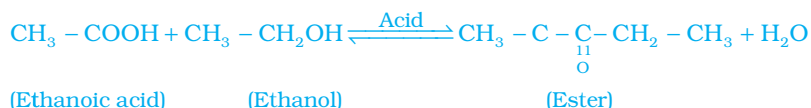

Generally, esters are sweet-smelling substances. These are used in making perfumes and as flavouring agents. On treating with sodium hydroxide, which is an alkali, the ester is converted back to alcohol and sodium salt of carboxylic acid. This reaction is known as saponification because it is used in the preparation of soap. Soaps are sodium or potassium salts of long chain carboxylic acid.

Activity 4.7

- Compare the pH of dilute acetic acid and dilute hydrochloric acid using both litmus paper and universal indicator.
- Are both acids indicated by the litmus test?
- Does the universal indicator show them as equally strong acids?

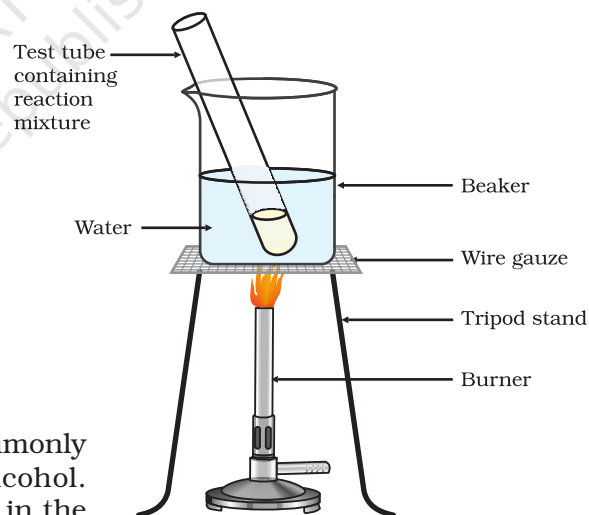
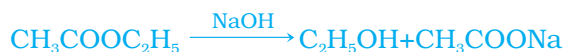

Figure 4.11
Formation of ester



- (ii) *Reaction with a base:* Like mineral acids, ethanoic acid reacts with a base such as sodium hydroxide to give a salt (sodium ethanoate or commonly called sodium acetate) and water:



How does ethanoic acid react with carbonates and hydrogencarbonates?

Let us perform an activity to find out.

Activity 4.9

- Set up the apparatus as shown in Chapter 2, Activity 2.5.
- Take a spatula full of sodium carbonate in a test tube and add 2 mL of dilute ethanoic acid.
- What do you observe?
- Pass the gas produced through freshly prepared lime-water. What do you observe?
- Can the gas produced by the reaction between ethanoic acid and sodium carbonate be identified by this test?
- Repeat this Activity with sodium hydrogencarbonate instead of sodium carbonate.

- (iii) *Reaction with carbonates and hydrogencarbonates:* Ethanoic acid reacts with carbonates and hydrogencarbonates to give rise to a salt, carbon dioxide and water. The salt produced is commonly called sodium acetate.



Q U E S T I O N S

1. How would you distinguish experimentally between an alcohol and a carboxylic acid?
2. What are oxidising agents?



4.5 SOAPS AND DETERGENTS

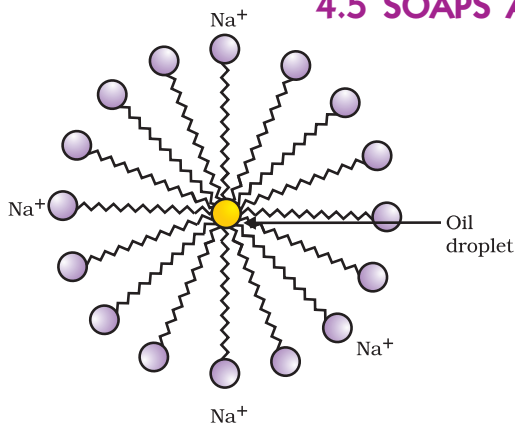

Figure 4.12
Formation of micelles

Activity 4.10

- Take about 10 mL of water each in two test tubes.
- Add a drop of oil (cooking oil) to both the test tubes and label them as A and B.
- To test tube B, add a few drops of soap solution.
- Now shake both the test tubes vigorously for the same period of time.
- Can you see the oil and water layers separately in both the test tubes immediately after you stop shaking them?
- Leave the test tubes undisturbed for some time and observe. Does the oil layer separate out? In which test tube does this happen first?

This activity demonstrates the effect of soap in cleaning. Most dirt is oily in nature and as you know, oil does not dissolve in water. The molecules of soap are sodium or potassium salts of long-chain carboxylic acids. The ionic-end of soap interacts with water while the carbon chain interacts with oil. The soap molecules, thus form structures called micelles (see Fig. 4.12) where one end of the molecules is towards the oil droplet while the ionic-end faces outside. This forms an emulsion in water. The soap micelle thus helps in pulling out the dirt in water and we can wash our clothes clean (Fig. 4.13).

Can you draw the structure of the micelle that would be formed if you dissolve soap in a hydrocarbon?

More to Know!

Micelles

Soaps are molecules in which the two ends have differing properties, one is hydrophilic, that is, it interacts with water, while the other end is hydrophobic, that is, it interacts with hydrocarbons. When soap is at the surface of water, the hydrophobic 'tail' of soap will not be soluble in water and the soap will align along the surface of water with the ionic end in water and the hydrocarbon 'tail' protruding out of water. Inside water,

these molecules have a unique orientation that keeps the hydrocarbon portion out of the water. Thus, clusters of molecules in which the hydrophobic tails are in the interior of the cluster and the ionic ends are on the surface of the cluster. This formation is called a micelle. Soap in the form of a micelle is able to clean, since the oily dirt will be collected in the centre of the micelle. The micelles stay in solution as a colloid and will not come together to precipitate because of ion-ion repulsion. Thus, the dirt suspended in the micelles is also easily rinsed away. The soap micelles are large enough to scatter light. Hence a soap solution appears cloudy.

Figure 4.13 Effect of soap in cleaning

Activity 4.11

- Take about 10 mL of distilled water (or rain water) and 10 mL of hard water (from a tubewell or hand-pump) in separate test tubes.
- Add a couple of drops of soap solution to both.
- Shake the test tubes vigorously for an equal period of time and observe the amount of foam formed.
- In which test tube do you get more foam?
- In which test tube do you observe a white curdy precipitate?

Note for the teacher: If hard water is not available in your locality, prepare some hard water by dissolving hydrogencarbonates/sulphates/chlorides of calcium or magnesium in water.

Activity 4.12

- Take two test tubes with about 10 mL of hard water in each.
- Add five drops of soap solution to one and five drops of detergent solution to the other.
- Shake both test tubes for the same period.
- Do both test tubes have the same amount of foam?
- In which test tube is a curdy solid formed?

Have you ever observed while bathing that foam is formed with difficulty and an insoluble substance (scum) remains after washing with water? This is caused by the reaction of soap with the calcium and magnesium salts, which cause the hardness of water. Hence you need to use a larger amount of soap. This problem is overcome by using another class of compounds called detergents as cleansing agents. Detergents are generally sodium salts of sulphonic acids or ammonium salts with chlorides or bromides ions, etc. Both have long hydrocarbon chain. The charged ends of these compounds do not form insoluble precipitates with the calcium and magnesium ions in hard water. Thus, they remain effective in hard water. Detergents are usually used to make shampoos and products for cleaning clothes.

Q U E S T I O N S

1. Would you be able to check if water is hard by using a detergent?
2. People use a variety of methods to wash clothes. Usually after adding the soap, they 'beat' the clothes on a stone, or beat it with a paddle, scrub with a brush or the mixture is agitated in a washing machine. Why is agitation necessary to get clean clothes?



What you have learnt

- Carbon is a versatile element that forms the basis for all living organisms and many of the things we use.
- This large variety of compounds is formed by carbon because of its tetravalency and the property of catenation that it exhibits.
- Covalent bonds are formed by the sharing of electrons between two atoms so that both can achieve a completely filled outermost shell.
- Carbon forms covalent bonds with itself and other elements such as hydrogen, oxygen, sulphur, nitrogen and chlorine.
- Carbon also forms compounds containing double and triple bonds between carbon atoms. These carbon chains may be in the form of straight chains, branched chains or rings.
- The ability of carbon to form chains gives rise to a homologous series of compounds in which the same functional group is attached to carbon chains of different lengths.
- The functional groups such as alcohols, aldehydes, ketones and carboxylic acids bestow characteristic properties to the carbon compounds that contain them.
- Carbon and its compounds are some of our major sources of fuels.
- Ethanol and ethanoic acid are carbon compounds of importance in our daily lives.
- The action of soaps and detergents is based on the presence of both hydrophobic and hydrophilic groups in the molecule and this helps to emulsify the oily dirt and hence its removal.

EXERCISES

1. Ethane, with the molecular formula C_2H_6 has
 - (a) 6 covalent bonds.
 - (b) 7 covalent bonds.
 - (c) 8 covalent bonds.
 - (d) 9 covalent bonds.
2. Butanone is a four-carbon compound with the functional group
 - (a) carboxylic acid.
 - (b) aldehyde.
 - (c) ketone.
 - (d) alcohol.
3. While cooking, if the bottom of the vessel is getting blackened on the outside, it means that
 - (a) the food is not cooked completely.
 - (b) the fuel is not burning completely.
 - (c) the fuel is wet.
 - (d) the fuel is burning completely.

4. Explain the nature of the covalent bond using the bond formation in CH_3Cl .
5. Draw the electron dot structures for
 - (a) ethanoic acid.
 - (b) H_2S .
 - (c) propanone.
 - (d) F_2 .
6. What is an homologous series? Explain with an example.
7. How can ethanol and ethanoic acid be differentiated on the basis of their physical and chemical properties?
8. Why does micelle formation take place when soap is added to water? Will a micelle be formed in other solvents such as ethanol also?
9. Why are carbon and its compounds used as fuels for most applications?
10. Explain the formation of scum when hard water is treated with soap.
11. What change will you observe if you test soap with litmus paper (red and blue)?
12. What is hydrogenation? What is its industrial application?
13. Which of the following hydrocarbons undergo addition reactions:
 C_2H_6 , C_3H_8 , C_3H_6 , C_2H_2 and CH_4 .
14. Give a test that can be used to differentiate between saturated and unsaturated hydrocarbons.
15. Explain the mechanism of the cleaning action of soaps.

Group Activity

- I Use molecular model kits to make models of the compounds you have learnt in this Chapter.
- II
 - Take about 20 mL of castor oil/cotton seed oil/linseed oil/soyabean oil in a beaker. Add 30 mL of 20 % sodium hydroxide solution. Heat the mixture with continuous stirring for a few minutes till the mixture thickens. Add 5-10 g of common salt to this. Stir the mixture well and allow it to cool.
 - You can cut out the soap in fancy shapes. You can also add perfume to the soap before it sets.



CHAPTER 5

Periodic Classification of Elements



1064CH05

In Class IX we have learnt that matter around us is present in the form of elements, compounds and mixtures and the elements contain atoms of only one type. Do you know how many elements are known till date? At present, 118 elements are known to us. All these have different properties. Out of these 118, only 94 are naturally occurring.

As different elements were being discovered, scientists gathered more and more information about the properties of these elements. They found it difficult to organise all that was known about the elements. They started looking for some pattern in their properties, on the basis of which they could study such a large number of elements with ease.

5.1 MAKING ORDER OUT OF CHAOS – EARLY ATTEMPTS AT THE CLASSIFICATION OF ELEMENTS

We have been learning how various things or living beings can be classified on the basis of their properties. Even in other situations, we come across instances of organisation based on some properties. For example, in a shop, soaps are kept together at one place while biscuits are kept together elsewhere. Even among soaps, bathing soaps are stacked separately from washing soaps. Similarly, scientists made several attempts to classify elements according to their properties and obtain an orderly arrangement out of chaos.

The earliest attempt to classify the elements resulted in grouping the then known elements as metals and non-metals. Later further classifications were tried out as our knowledge of elements and their properties increased.

5.1.1 Döbereiner's Triads

In the year 1817, Johann Wolfgang Döbereiner, a German chemist, tried to arrange the elements with similar properties into groups. He identified some groups having three elements each. So he called these groups 'triads'. Döbereiner showed that when the three elements in a



Figure 5.1

Imagine you and your friends have found pieces of an old map to reach a treasure. Would it be easy or chaotic to find the way to the treasure? Similar chaos was there in Chemistry as elements were known but there was no clue as to how to classify and study about them.

triad were written in the order of increasing atomic masses; the atomic mass of the middle element was roughly the average of the atomic masses of the other two elements.

For example, take the triad consisting of lithium (Li), sodium (Na) and potassium (K) with the respective atomic masses 6.9, 23.0 and 39.0. What is the average of the atomic masses of Li and K? How does this compare with the atomic mass of Na?

Given below (Table 5.1) are some groups of three elements. These elements are arranged downwards in order of increasing atomic masses. Can you find out which of these groups form Döbereiner triads?

Table 5.1

Group A element	Atomic mass	Group B element	Atomic mass	Group C elements	Atomic mass
N	14.0	Ca	40.1	Cl	35.5
P	31.0	Sr	87.6	Br	79.9
As	74.9	Ba	137.3	I	126.9

You will find that groups B and C form Döbereiner triads. Döbereiner could identify only three triads from the elements known at that time (Table 5.2). Hence, this system of classification into triads was not found to be useful.

Table 5.2
Döbereiner's triads

Li	Ca	Cl
Na	Sr	Br
K	Ba	I

Johann Wolfgang Döbereiner (1780-1849)

Johann Wolfgang Döbereiner studied as a pharmacist at Münchberg in Germany, and then studied chemistry at Strasbourg. Eventually he became a professor of chemistry and pharmacy at the University of Jena. Döbereiner made the first observations on platinum as a catalyst and discovered similar triads of elements which led to the development of the Periodic Table of elements.



5.1.2 Newlands' Law of Octaves

The attempts of Döbereiner encouraged other chemists to correlate the properties of elements with their atomic masses. In 1866, John Newlands, an English scientist, arranged the then known elements in the order of increasing atomic masses. He started with the element having the lowest atomic mass (hydrogen) and ended at thorium which was the 56th element. He found that every eighth element had properties similar to that of the first. He compared this to the octaves found in music. Therefore, he called it the 'Law of Octaves'. It is known as 'Newlands' Law of Octaves'. In Newlands' Octaves, the properties of lithium and sodium were found to be the same. Sodium is the eighth element after lithium. Similarly, beryllium and magnesium resemble each other. A part of the original form of Newlands' Octaves is given in Table 5.3.

Table 5.3 Newlands' Octaves

Notes of music:	sa (do)	re (re)	ga (mi)	ma (fa)	pa (so)	da (la)	ni (ti)
	H	Li	Be	B	C	N	O
	F	Na	Mg	Al	Si	P	S
	Cl	K	Ca	Cr	Ti	Mn	Fe
	Co and Ni	Cu	Zn	Y	In	As	Se
	Br	Rb	Sr	Ce and La	Zr	—	—

Do You Know?**Are you familiar with musical notes?**

In the Indian system of music, there are seven musical notes in a scale – *sa, re, ga, ma, pa, da, ni*. In the west, they use the notations – *do, re, mi, fa, so, la, ti*. The notes in a scale are separated by whole and half-step frequency intervals of tones and semitones. A musician uses these notes for composing the music of a song. Naturally, there must be some repetition of notes. Every eighth note is similar to the first one and it is the first note of the next scale.

- It was found that the Law of Octaves was applicable only upto calcium, as after calcium every eighth element did not possess properties similar to that of the first.
- It was assumed by Newlands that only 56 elements existed in nature and no more elements would be discovered in the future. But, later on, several new elements were discovered, whose properties did not fit into the Law of Octaves.
- In order to fit elements into his Table, Newlands adjusted two elements in the same slot, but also put some unlike elements under the same note. Can you find examples of these from Table 5.3? Note that cobalt and nickel are in the same slot and these are placed in the same column as fluorine, chlorine and bromine which have very different properties than these elements. Iron, which resembles cobalt and nickel in properties, has been placed far away from these elements. With the discovery of noble gases, the Law of Octaves became irrelevant. Thus, Newlands' Law of Octaves worked well with lighter elements only.

Q U E S T I O N S

- Did Döbereiner's triads also exist in the columns of Newlands' Octaves? Compare and find out.
- What were the limitations of Döbereiner's classification?
- What were the limitations of Newlands' Law of Octaves?

**5.2 MAKING ORDER OUT OF CHAOS – MENDELÉEV'S PERIODIC TABLE**

Even after the rejection of Newlands' Law of Octaves, many scientists continued to search for a pattern that correlated the properties of elements with their atomic masses.

The main credit for classifying elements goes to Dmitri Ivanovich MendeléeV, a Russian chemist. He was the most important contributor to the early development of a Periodic Table of elements wherein the elements were arranged on the basis of their fundamental property, the atomic mass, and also on the similarity of chemical properties.

Dmitri Ivanovich MendeléeV (1834-1907)

Dmitri Ivanovich MendeléeV was born in Tobolsk in Western Siberia, Russia on 8 February 1834. After his early education, MendeléeV could join a university only due to the efforts of his mother. Dedicating his investigations to his mother he wrote, "She instructed with example, corrected with love and travelled with me to places spending her last resources and strength. She knew that with the



aid of science without violence, with love but firmness, all superstitions, untruth and errors can be removed." The arrangement of elements he proposed is called MendeléeV's Periodic Table. The Periodic Table proved to be the unifying principle in chemistry. It was the motivation for the discovery of some new elements.

When MendeléeV started his work, 63 elements were known. He examined the relationship between the atomic masses of the elements and their physical and chemical properties. Among chemical properties, MendeléeV concentrated on the compounds formed by elements with oxygen and hydrogen. He selected hydrogen and oxygen as they are very reactive and formed compounds with most elements. The formulae of the hydrides and oxides formed by an element were treated as one of the basic properties of an element for its classification. He then took 63 cards and on each card he wrote down the properties of one element. He sorted out the elements with similar properties and pinned the cards together on a wall. He observed that most of the elements got a place in a Periodic Table and were arranged in the order of their increasing atomic masses. It was also observed that there occurs a periodic recurrence of elements with similar physical and chemical properties. On this basis, MendeléeV formulated a Periodic Law, which states that 'the properties of elements are the periodic function of their atomic masses'.

MendeléeV's Periodic Table contains vertical columns called 'groups' and horizontal rows called 'periods' (Table 5.4).

Table 5.4 Mendeléev's Periodic Table

Group	I		II		III		IV		V		VI		VII		VIII		
Oxide Hydride	R ₂ O RH		RO RH ₂		R ₂ O ₃ RH ₃		RO ₂ RH ₄		R ₂ O ₅ RH ₃		RO ₃ RH ₂		R ₂ O ₇ RH		RO ₄		
Periods ↓	A	B	A	B	A	B	A	B	A	B	A	B	A	B	Transition series		
1	H 1.008																
2	Li 6.939		Be 9.012		B 10.81		C 12.011		N 14.007		O 15.999		F 18.998				
3	Na 22.99		Mg 24.31		Al 29.98		Si 28.09		P 30.974		S 32.06		Cl 35.453				
4 First series:	K 39.102		Ca 40.08		Sc 44.96		Ti 47.90		V 50.94		Cr 50.20		Mn 54.94		Fe 55.85	Co 58.93	Ni 58.71
Second series:	Cu 63.54		Zn 65.37		Ga 69.72		Ge 72.59		As 74.92		Se 78.96		Br 79.909				
5 First series:	Rb 85.47		Sr 87.62		Y 88.91		Zr 91.22		Nb 92.91		Mo 95.94		Tc 99		Ru 101.07	Rh 102.91	Pd 106.4
Second series:	Ag 107.87		Cd 112.40		In 114.82		Sn 118.69		Sb 121.75		Te 127.60		I 126.90				
6 First series:	Cs 132.90		Ba 137.34		La 138.91		Hf 178.49		Ta 180.95		W 183.85				Os 190.2	Ir 192.2	Pt 195.09
Second series:	Au 196.97		Hg 200.59		Tl 204.37		Pb 207.19		Bi 208.98								

Mendeléev's Periodic Table was published in a German journal in 1872. In the formula for oxides and hydrides at the top of the columns, the letter 'R' is used to represent any of the elements in the group. Note the way formulae are written. For example, the hydride of carbon, CH₄, is written as RH₄ and the oxide CO₂, as RO₂.

5.2.1 Achievements of Mendeléev's Periodic Table

While developing the Periodic Table, there were a few instances where Mendeléev had to place an element with a slightly greater atomic mass before an element with a slightly lower atomic mass. The sequence was inverted so that elements with similar properties could be grouped together. For example, cobalt (atomic mass 58.9) appeared before nickel (atomic mass 58.7). Looking at Table 5.4, can you find out one more such anomaly?

Further, Mendeléev left some gaps in his Periodic Table. Instead of looking upon these gaps as defects, Mendeléev boldly predicted the existence of some elements that had not been discovered at that time. Mendeléev named them by prefixing a Sanskrit numeral, *Eka* (one) to the name of preceding element in the same group. For instance, scandium, gallium and germanium, discovered later, have properties

similar to *Eka*-boron, *Eka*-aluminium and *Eka*-silicon, respectively. The properties of *Eka*-Aluminium predicted by Mendeléev and those of the element, gallium which was discovered later and replaced *Eka*-aluminium, are listed as follows (Table 5.5).

Table 5.5 Properties of *eka*-aluminium and gallium

Property	<i>Eka</i> -aluminium	Gallium
Atomic Mass	68	69.7
Formula of Oxide	E_2O_3	Ga_2O_3
Formula of Chloride	ECl_3	$GaCl_3$

This provided convincing evidence for both the correctness and usefulness of Mendeléev's Periodic Table. Further, it was the extraordinary success of Mendeléev's prediction that led chemists not only to accept his Periodic Table but also recognise him, as the originator of the concept on which it is based. Noble gases like helium (He), neon (Ne) and argon (Ar) have been mentioned in many a context before this. These gases were discovered very late because they are very inert and present in extremely low concentrations in our atmosphere. One of the strengths of Mendeléev's Periodic Table was that, when these gases were discovered, they could be placed in a new group without disturbing the existing order.

5.2.2 Limitations of Mendeléev's Classification

Electronic configuration of hydrogen resembles that of alkali metals. Like alkali metals, hydrogen combines with halogens, oxygen and sulphur to form compounds having similar formulae, as shown in the examples here.

Compounds of H	Compounds of Na
HCl	NaCl
H_2O	Na_2O
H_2S	Na_2S

On the other hand, just like halogens, hydrogen also exists as diatomic molecules and it combines with metals and non-metals to form covalent compounds.

Activity 5.1

- Looking at its resemblance to alkali metals and the halogen family, try to assign hydrogen a correct position in Mendeléev's Periodic Table.
- To which group and period should hydrogen be assigned?

Certainly, no fixed position can be given to hydrogen in the Periodic Table. This was the first limitation of Mendeléev's Periodic Table. He could not assign a correct position to hydrogen in his Table.

Isotopes were discovered long after Mendeléev had proposed his periodic classification of elements. Let us recall that isotopes of an element have similar chemical properties, but different atomic masses.

Activity 5.2

- Consider the isotopes of chlorine, Cl-35 and Cl-37.
- Would you place them in different slots because their atomic masses are different?
- Or would you place them in the same position because their chemical properties are the same?

Thus, isotopes of all elements posed a challenge to Mendeleev's Periodic Law. Another problem was that the atomic masses do not increase in a regular manner in going from one element to the next. So it was not possible to predict how many elements could be discovered between two elements — especially when we consider the heavier elements.

Q U E S T I O N S

1. Use Mendeléev's Periodic Table to predict the formulae for the oxides of the following elements:
K, C, Al, Si, Ba.
2. Besides gallium, which other elements have since been discovered that were left by Mendeléev in his Periodic Table? (any two)
3. What were the criteria used by Mendeléev in creating his Periodic Table?
4. Why do you think the noble gases are placed in a separate group?

5.3 MAKING ORDER OUT OF CHAOS – THE MODERN PERIODIC TABLE

In 1913, Henry Moseley showed that the atomic number (symbolised as Z) of an element is a more fundamental property than its atomic mass. Accordingly, Mendeléev's Periodic Law was modified and atomic number was adopted as the basis of Modern Periodic Table and the Modern Periodic Law can be stated as follows:

'Properties of elements are a periodic function of their atomic number.'

Let us recall that the atomic number gives us the number of protons in the nucleus of an atom and this number increases by one in going from one element to the next. Elements, when arranged in order of increasing atomic number, lead us to the classification known as the Modern Periodic Table (Table 5.6). Prediction of properties of elements could be made with more precision when elements were arranged on the basis of increasing atomic number.

Activity 5.3

- How were the positions of cobalt and nickel resolved in the Modern Periodic Table?
- How were the positions of isotopes of various elements decided in the Modern Periodic Table?
- Is it possible to have an element with atomic number 1.5 placed between hydrogen and helium?
- Where do you think should hydrogen be placed in the Modern Periodic Table?

Table 5.6 Modern Periodic Table

The zigzag line separates the metals from the non-metals.

Metals

Metalloids

Non-metals

GROUP NUMBER	1	2	GROUP NUMBER										17	18							
1	H Hydrogen 1.0	He Helium 4.0																			
2	3 Li Lithium 6.9	4 Be Beryllium 9.0	5 B Boron 10.8	6 C Carbon 12.0	7 N Nitrogen 14.0	8 O Oxygen 16.0	9 F Fluorine 19.0	10 Ne Neon 20.2	11 Na Sodium 23.0	12 Mg Magnesium 24.3	13 Al Aluminium 27.0	14 Si Silicon 28.1	15 P Phosphorus 31.0	16 S Sulphur 32.1	17 Cl Chlorine 35.5	18 Ar Argon 39.9					
3	21 Sc Scandium 45.0	22 Ti Titanium 47.8	23 V Vanadium 50.9	24 Cr Chromium 52.0	25 Mn Manganese 54.9	26 Fe Iron 55.9	27 Co Cobalt 58.9	28 Ni Nickel 58.7	29 Cu Copper 63.5	30 Zn Zinc 65.4	31 Ga Gallium 69.7	32 Ge Germanium 72.6	33 As Arsenic 74.9	34 Se Selenium 79.0	35 Br Bromine 79.9	36 Kr Krypton 83.8					
4	19 K Potassium 39.1	20 Ca Calcium 40.1	37 Rb Rubidium 85.5	38 Sr Strontium 87.6	39 Y Yttrium 88.9	40 Zr Zirconium 91.2	41 Nb Niobium 92.9	42 Mo Molybdenum 95.9	43 Tc Technetium (99)	44 Ru Ruthenium 101.1	45 Rh Rhodium 102.3	46 Pd Palladium 106.4	47 Ag Silver 107.9	48 Cd Cadmium 112.4	49 In Indium 114.8	50 Sn Tin 118.7	51 Sb Antimony 121.8	52 Te Tellurium 127.6	53 I Iodine 126.9	54 Xe Xenon 131.3	
5	55 Cs Caesium 132.9	56 Ba Barium 137.3	87 Fr Francium (223)	88 Ra Radium (226)	89 Ac Actinium (227)	90 Th Thorium 232.0	91 Pa Protactinium (231)	92 U Uranium 238.1	93 Np Neptunium (237)	94 Pu Plutonium (242)	95 Am Americium (243)	96 Cm Curium (247)	97 Bk Berkelium (245)	98 Cf Californium (251)	99 Es Einsteinium (254)	100 Fm Fermium (253)	101 Md Mendelevium (256)	102 No Nobelium (254)	103 Lr Lawrencium (257)		
6	57 La* Lanthanum 138.9	58 Ce Cerium 140.1	59 Pr Praseodymium 140.9	60 Nd Neodymium 144.2	61 Pm Promethium (145)	62 Sm Samarium 150.4	63 Eu Europium 152.0	64 Gd Gadolinium 157.3	65 Tb Terbium 158.9	66 Dy Dysprosium 162.5	67 Ho Holmium 164.9	68 Er Erbium 167.3	69 Tm Thulium 168.9	70 Yb Ytterbium 173.0	71 Lu Lutetium 175.5	81 Tl Thallium 204.4	82 Pb Lead 207.2	83 Bi Bismuth 209.0	84 Po Polonium (210)	85 At Astatine (210)	86 Rn Radon (222)
7	89 Ac** Actinium (227)	90 Th Thorium 232.0	91 Pa Protactinium (231)	92 U Uranium 238.1	93 Np Neptunium (237)	94 Pu Plutonium (242)	95 Am Americium (243)	96 Cm Curium (247)	97 Bk Berkelium (245)	98 Cf Californium (251)	99 Es Einsteinium (254)	100 Fm Fermium (253)	101 Md Mendelevium (256)	102 No Nobelium (254)	103 Lr Lawrencium (257)	113 Nh Nihonium (286)	114 Fl Flerovium (289)	115 Mc Moscovium (290)	116 Lv Livermorium (293)	117 Ts Tennessine (294)	118 Og Oganesson (294)

* Lanthanoides

** Actinoides

As we can see, the Modern Periodic Table takes care of three limitations of Mendl ev's Periodic Table. The anomalous position of hydrogen can be discussed after we see what are the bases on which the position of an element in the Modern Periodic Table depends.

5.3.1 Position of Elements in the Modern Periodic Table

The Modern Periodic Table has 18 vertical columns known as 'groups' and 7 horizontal rows known as 'periods'. Let us see what decides the placing of an element in a certain group and period.

Activity 5.4

- Look at the group 1 of the Modern Periodic Table, and name the elements present in it.
- Write down the electronic configuration of the first three elements of group 1.
- What similarity do you find in their electronic configurations?
- How many valence electrons are present in these three elements?

You will find that all these elements contain the same number of valence electrons. Similarly, you will find that the elements present in any one group have the same number of valence electrons. For example, elements fluorine (F) and chlorine (Cl), belong to group 17, how many electrons do fluorine and chlorine have in their outermost shells? Hence, we can say that groups in the Periodic Table signify an identical outer-shell electronic configuration. On the other hand, the number of shells increases as we go down the group.

There is an anomaly when it comes to the position of hydrogen because it can be placed either in group 1 or group 17 in the first period. Can you say why?

Activity 5.5

- If you look at the Modern Periodic Table (5.6), you will find that the elements Li, Be, B, C, N, O, F, and Ne are present in the second period. Write down their electronic configurations.
- Do these elements also contain the same number of valence electrons?
- Do they contain the same number of shells?

You will find that these elements of second period do not have the same number of valence electrons, but they contain the same number of shells. You also observe that the number of valence shell electrons increases by one unit, as the atomic number increases by one unit on moving from left to right in a period.

Or we can say that atoms of different elements with the same number of occupied shells are placed in the same period. Na, Mg, Al, Si, P, S, Cl and Ar belong to the third period of the Modern Periodic Table, since the electrons in the atoms of these elements are filled in K, L and M shells. Write the electronic configuration of these elements and confirm the above statement. Each period marks a new electronic shell getting filled.

How many elements are there in the first, second, third and fourth periods?

We can explain the number of elements in these periods based on how electrons are filled into various shells. You will study the details of this in higher classes. Recall that the maximum number of electrons that can be accommodated in a shell depends on the formula $2n^2$ where 'n' is the number of the given shell from the nucleus.

For example,

K Shell - $2 \times (1)^2 = 2$, hence the first period has 2 elements.

L Shell - $2 \times (2)^2 = 8$, hence the second period has 8 elements.

The third, fourth, fifth, sixth and seventh periods have 8, 18, 18, 32 and 32 elements respectively.

The reason for this you will study in higher classes.

The position of an element in the Periodic Table tells us about its chemical reactivity. As you have learnt, the valence electrons determine the kind and number of bonds formed by an element. Can you now say why MendeléeV's choice of formulae of compounds as the basis for deciding the position of an element in his Table was a good one? How would this lead to elements with similar chemical properties being placed in the same group?

5.3.2 Trends in the Modern Periodic Table

Valency : As you know, the valency of an element is determined by the number of valence electrons present in the outermost shell of its atom.

Activity 5.6

- How do you calculate the valency of an element from its electronic configuration?
- What is the valency of magnesium with atomic number 12 and sulphur with atomic number 16?
- Similarly find out the valencies of the first twenty elements.
- How does the valency vary in a period on going from left to right?
- How does the valency vary in going down a group?

Atomic size: The term atomic size refers to the radius of an atom. The atomic size may be visualised as the distance between the centre of the nucleus and the outermost shell of an isolated atom. The atomic radius of hydrogen atom is 37 pm (picometre, $1 \text{ pm} = 10^{-12}\text{m}$).

Let us study the variation of atomic size in a group and in a period.

Activity 5.7

- Atomic radii of the elements of the second period are given below:
Period II elements : B Be O N Li C
Atomic radius (pm) : 88 111 66 74 152 77
- Arrange them in decreasing order of their atomic radii.
- Are the elements now arranged in the pattern of a period in the Periodic Table?
- Which elements have the largest and the smallest atoms?
- How does the atomic radius change as you go from left to right in a period?

You will see that the atomic radius decreases in moving from left to right along a period. This is due to an increase in nuclear charge which tends to pull the electrons closer to the nucleus and reduces the size of the atom.

Activity 5.8

- Study the variation in the atomic radii of first group elements given below and arrange them in an increasing order.
Group 1 Elements : Na Li Rb Cs K
Atomic Radius (pm): 186 152 244 262 231
- Name the elements which have the smallest and the largest atoms.
- How does the atomic size vary as you go down a group?

You will see that the atomic size increases down the group. This is because new shells are being added as we go down the group. This increases the distance between the outermost electrons and the nucleus so that the atomic size increases in spite of the increase in nuclear charge.

Metallic and Non-metallic Properties

Activity 5.9

- Examine elements of the third period and classify them as metals and non-metals.
- On which side of the Periodic Table do you find the metals?
- On which side of the Periodic Table do you find the non-metals?

As we can see, the metals like Na and Mg are towards the left-hand side of the Periodic Table while the non-metals like sulphur and chlorine are found on the right-hand side. In the middle, we have silicon, which is classified as a semi-metal or metalloid because it exhibits some properties of both metals and non-metals.

In the Modern Periodic Table, a zig-zag line separates metals from non-metals. The borderline elements – boron, silicon, germanium, arsenic, antimony, tellurium and polonium – are intermediate in properties and are called metalloids or semi-metals.

As you have seen in Chapter 3, metals tend to lose electrons while forming bonds, that is, they are electropositive in nature.

Activity 5.10

- How do you think the tendency to lose electrons changes in a group?
- How will this tendency change in a period?

As the effective nuclear charge acting on the valence shell electrons increases across a period, the tendency to lose electrons will decrease. Down the group, the effective nuclear charge experienced by valence

electrons is decreasing because the outermost electrons are farther away from the nucleus. Therefore, these can be lost easily. Hence metallic character decreases across a period and increases down a group.

Non-metals, on the other hand, are electronegative. They tend to form bonds by gaining electrons. Let us learn about the variation of this property.

Activity 5.11

- How would the tendency to gain electrons change as you go from left to right across a period?
- How would the tendency to gain electrons change as you go down a group?

As the trends in the electronegativity show, non-metals are found on the right-hand side of the Periodic Table towards the top.

These trends also help us to predict the nature of oxides formed by the elements because it is known to you that the oxides of metals are basic and that of non-metals are acidic in general.

Q U E S T I O N S

1. How could the Modern Periodic Table remove various anomalies of MendeléeV's Periodic Table?
2. Name two elements you would expect to show chemical reactions similar to magnesium. What is the basis for your choice?
3. Name
 - (a) three elements that have a single electron in their outermost shells.
 - (b) two elements that have two electrons in their outermost shells.
 - (c) three elements with filled outermost shells.
4.
 - (a) Lithium, sodium, potassium are all metals that react with water to liberate hydrogen gas. Is there any similarity in the atoms of these elements?
 - (b) Helium is an unreactive gas and neon is a gas of extremely low reactivity. What, if anything, do their atoms have in common?
5. In the Modern Periodic Table, which are the metals among the first ten elements?
6. By considering their position in the Periodic Table, which one of the following elements would you expect to have maximum metallic characteristic?

Ga Ge As Se Be

What you have learnt

- Elements are classified on the basis of similarities in their properties.
- Döbereiner grouped the elements into triads and Newlands gave the Law of Octaves.
- Mendeléeiev arranged the elements in increasing order of their atomic masses and according to their chemical properties.
- Mendeléeiev even predicted the existence of some yet to be discovered elements on the basis of gaps in his Periodic Table.
- Anomalies in arrangement of elements based on increasing atomic mass could be removed when the elements were arranged in order of increasing atomic number, a fundamental property of the element discovered by Moseley.
- Elements in the Modern Periodic Table are arranged in 18 vertical columns called groups and 7 horizontal rows called periods.
- Elements thus arranged show periodicity of properties including atomic size, valency or combining capacity and metallic and non-metallic character.

EXERCISES

1. Which of the following statements is not a correct statement about the trends when going from left to right across the periods of periodic Table.
(a) The elements become less metallic in nature.
(b) The number of valence electrons increases.
(c) The atoms lose their electrons more easily.
(d) The oxides become more acidic.
2. Element X forms a chloride with the formula XCl_2 , which is a solid with a high melting point. X would most likely be in the same group of the Periodic Table as
(a) Na (b) Mg (c) Al (d) Si
3. Which element has
(a) two shells, both of which are completely filled with electrons?
(b) the electronic configuration 2, 8, 2?
(c) a total of three shells, with four electrons in its valence shell?
(d) a total of two shells, with three electrons in its valence shell?
(e) twice as many electrons in its second shell as in its first shell?
4. (a) What property do all elements in the same column of the Periodic Table as boron have in common?
(b) What property do all elements in the same column of the Periodic Table as fluorine have in common?
5. An atom has electronic configuration 2, 8, 7.
(a) What is the atomic number of this element?
(b) To which of the following elements would it be chemically similar?
(Atomic numbers are given in parentheses.)
N(7) F(9) P(15) Ar(18)

6. The position of three elements A, B and C in the Periodic Table are shown below –

Group 16	Group 17
-	-
-	A
-	-
B	C

- State whether A is a metal or non-metal.
 - State whether C is more reactive or less reactive than A.
 - Will C be larger or smaller in size than B?
 - Which type of ion, cation or anion, will be formed by element A?
- Nitrogen (atomic number 7) and phosphorus (atomic number 15) belong to group 15 of the Periodic Table. Write the electronic configuration of these two elements. Which of these will be more electronegative? Why?
 - How does the electronic configuration of an atom relate to its position in the Modern Periodic Table?
 - In the Modern Periodic Table, calcium (atomic number 20) is surrounded by elements with atomic numbers 12, 19, 21 and 38. Which of these have physical and chemical properties resembling calcium?
 - Compare and contrast the arrangement of elements in MendeléeV's Periodic Table and the Modern Periodic Table.

Group Activity

- We have discussed the major attempts made for classifying elements. Find out (from the internet or library) about other attempts to classify elements.
- We have studied the long form of the Periodic Table. The Modern Periodic Law has been used to arrange elements in other ways too. Find out what are these.

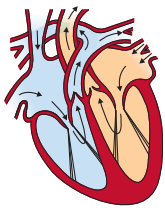

CHAPTER 6

Life Processes



1064CH06

How do we tell the difference between what is alive and what is not alive? If we see a dog running, or a cow chewing cud, or a man shouting loudly on the street, we know that these are living beings. What if the dog or the cow or the man were asleep? We would still think that they were alive, but how did we know that? We see them breathing, and we know that they are alive. What about plants? How do we know that they are alive? We see them green, some of us will say. But what about plants that have leaves of colours other than green? They grow over time, so we know that they are alive, some will say. In other words, we tend to think of some sort of movement, either growth-related or not, as common evidence for being alive. But a plant that is not visibly growing is still alive, and some animals can breathe without visible movement. So using visible movement as the defining characteristic of life is not enough.

Movements over very small scales will be invisible to the naked eye – movements of molecules, for example. Is this invisible molecular movement necessary for life? If we ask this question to professional biologists, they will say yes. In fact, viruses do not show any molecular movement in them (until they infect some cell), and that is partly why there is a controversy about whether they are truly alive or not.

Why are molecular movements needed for life? We have seen in earlier classes that living organisms are well-organised structures; they can have tissues, tissues have cells, cells have smaller components in them, and so on. Because of the effects of the environment, this organised, ordered nature of living structures is very likely to keep breaking down over time. If order breaks down, the organism will no longer be alive. So living creatures must keep repairing and maintaining their structures. Since all these structures are made up of molecules, they must move molecules around all the time.

What are the maintenance processes in living organisms? Let us explore.

6.1 WHAT ARE LIFE PROCESSES?

The maintenance functions of living organisms must go on even when they are not doing anything particular. Even when we are just sitting in

class, even if we are just asleep, this maintenance job has to go on. The processes which together perform this maintenance job are life processes.

Since these maintenance processes are needed to prevent damage and break-down, energy is needed for them. This energy comes from outside the body of the individual organism. So there must be a process to transfer a source of energy from outside the body of the organism, which we call food, to the inside, a process we commonly call nutrition. If the body size of the organisms is to grow, additional raw material will also be needed from outside. Since life on earth depends on carbon-based molecules, most of these food sources are also carbon-based. Depending on the complexity of these carbon sources, different organisms can then use different kinds of nutritional processes.

The outside sources of energy could be quite varied, since the environment is not under the control of the individual organism. These sources of energy, therefore, need to be broken down or built up in the body, and must be finally converted to a uniform source of energy that can be used for the various molecular movements needed for maintaining living structures, as well as to the kind of molecules the body needs to grow. For this, a series of chemical reactions in the body are necessary. Oxidising-reducing reactions are some of the most common chemical means to break-down molecules. For this, many organisms use oxygen sourced from outside the body. The process of acquiring oxygen from outside the body, and to use it in the process of break-down of food sources for cellular needs, is what we call respiration.

In the case of a single-celled organism, no specific organs for taking in food, exchange of gases or removal of wastes may be needed because the entire surface of the organism is in contact with the environment. But what happens when the body size of the organism increases and the body design becomes more complex? In multi-cellular organisms, all the cells may not be in direct contact with the surrounding environment. Thus, simple diffusion will not meet the requirements of all the cells.

We have seen previously how, in multi-cellular organisms, various body parts have specialised in the functions they perform. We are familiar with the idea of these specialised tissues, and with their organisation in the body of the organism. It is therefore not surprising that the uptake of food and of oxygen will also be the function of specialised tissues. However, this poses a problem, since the food and oxygen are now taken up at one place in the body of the organisms, while all parts of the body need them. This situation creates a need for a transportation system for carrying food and oxygen from one place to another in the body.

When chemical reactions use the carbon source and the oxygen for energy generation, they create by-products that are not only useless for the cells of the body, but could even be harmful. These waste by-products are therefore needed to be removed from the body and discarded outside by a process called excretion. Again, if the basic rules for body

design in multi-cellular organisms are followed, a specialised tissue for excretion will be developed, which means that the transportation system will need to transport waste away from cells to this excretory tissue.

Let us consider these various processes, so essential to maintain life, one by one.

Q U E S T I O N S

1. Why is diffusion insufficient to meet the oxygen requirements of multi-cellular organisms like humans?
2. What criteria do we use to decide whether something is alive?
3. What are outside raw materials used for by an organism?
4. What processes would you consider essential for maintaining life?



6.2 NUTRITION

When we walk or ride a bicycle, we are using up energy. Even when we are not doing any apparent activity, energy is needed to maintain a state of order in our body. We also need materials from outside in order to grow, develop, synthesise protein and other substances needed in the body. This source of energy and materials is the food we eat.

How do living things get their food?

The general requirement for energy and materials is common in all organisms, but it is fulfilled in different ways. Some organisms use simple food material obtained from inorganic sources in the form of carbon dioxide and water. These organisms, the autotrophs, include green plants and some bacteria. Other organisms utilise complex substances. These complex substances have to be broken down into simpler ones before they can be used for the upkeep and growth of the body. To achieve this, organisms use bio-catalysts called enzymes. Thus, the heterotrophs survival depends directly or indirectly on autotrophs. Heterotrophic organisms include animals and fungi.

6.2.1 Autotrophic Nutrition

Carbon and energy requirements of the autotrophic organism are fulfilled by photosynthesis. It is the process by which autotrophs take in substances from the outside and convert them into stored forms of energy. This material is taken in the form of carbon dioxide and water which is converted into carbohydrates in the presence of sunlight and chlorophyll. Carbohydrates are utilised for providing energy to the plant. We will study how this takes place in the next section. The carbohydrates which are not used immediately are stored in the form of starch, which serves as the internal energy reserve to be used as and when required by the plant. A somewhat similar situation is seen in us where some of the energy derived from the food we eat is stored in our body in the form of glycogen.



Let us now see what actually happens during the process of photosynthesis. The following events occur during this process –

- (i) Absorption of light energy by chlorophyll.
- (ii) Conversion of light energy to chemical energy and splitting of water molecules into hydrogen and oxygen.
- (iii) Reduction of carbon dioxide to carbohydrates.

These steps need not take place one after the other immediately. For example, desert plants take up carbon dioxide at night and prepare an intermediate which is acted upon by the energy absorbed by the chlorophyll during the day.

Let us see how each of the components of the above reaction are necessary for photosynthesis.

If you carefully observe a cross-section of a leaf under the microscope (shown in Fig. 6.1), you will notice that some cells contain green dots. These green dots are cell organelles called chloroplasts which contain chlorophyll. Let us do an activity which demonstrates that chlorophyll is essential for photosynthesis.

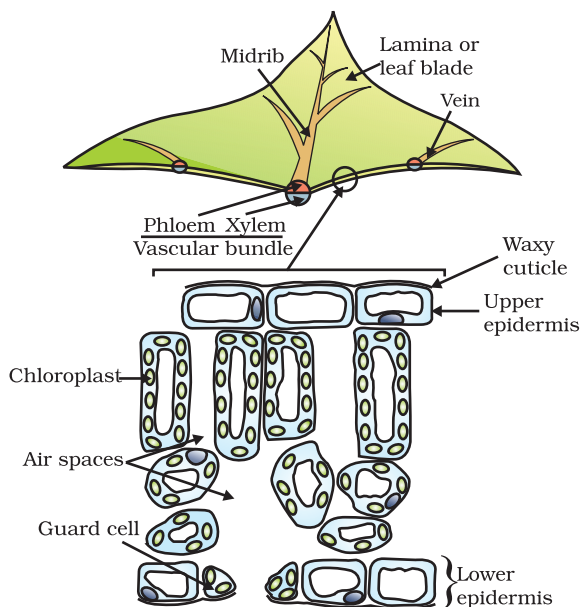

Figure 6.1
Cross-section of a leaf

Activity 6.1

- Take a potted plant with variegated leaves – for example, money plant or crotons.
- Keep the plant in a dark room for three days so that all the starch gets used up.
- Now keep the plant in sunlight for about six hours.
- Pluck a leaf from the plant. Mark the green areas in it and trace them on a sheet of paper.
- Dip the leaf in boiling water for a few minutes.
- After this, immerse it in a beaker containing alcohol.
- Carefully place the above beaker in a water-bath and heat till the alcohol begins to boil.
- What happens to the colour of the leaf? What is the colour of the solution?
- Now dip the leaf in a dilute solution of iodine for a few minutes.
- Take out the leaf and rinse off the iodine solution.
- Observe the colour of the leaf and compare this with the tracing of the leaf done in the beginning (Fig. 6.2).
- What can you conclude about the presence of starch in various areas of the leaf?

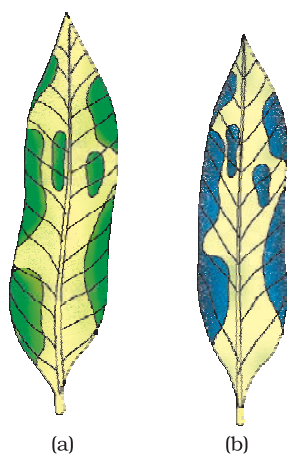

Figure 6.2
Variegated leaf (a) before and (b) after starch test

Now, let us study how the plant obtains carbon dioxide. In Class IX, we had talked about stomata (Fig. 6.3) which are tiny pores present on the surface of the leaves. Massive amounts of gaseous exchange takes place in the leaves through these pores for the purpose of photosynthesis. But it is important to note here that exchange of gases occurs across the surface of stems, roots and leaves as well. Since large amounts of water can also be lost through these stomata, the plant closes these pores when it does not need carbon dioxide for photosynthesis. The opening and closing of the pore is a function of the guard cells. The guard cells swell when water flows into them, causing the stomatal pore to open. Similarly the pore closes if the guard cells shrink.

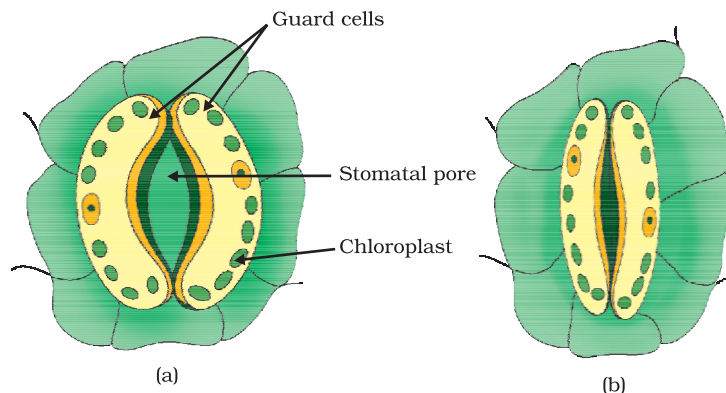

Figure 6.3 (a) Open and (b) closed stomatal pore

Activity 6.2

- Take two healthy potted plants which are nearly the same size.
- Keep them in a dark room for three days.
- Now place each plant on separate glass plates. Place a watch-glass containing potassium hydroxide by the side of one of the plants. The potassium hydroxide is used to absorb carbon dioxide.
- Cover both plants with separate bell-jars as shown in Fig. 6.4.
- Use vaseline to seal the bottom of the jars to the glass plates so that the set-up is air-tight.
- Keep the plants in sunlight for about two hours.
- Pluck a leaf from each plant and check for the presence of starch as in the above activity.
- Do both the leaves show the presence of the same amount of starch?
- What can you conclude from this activity?

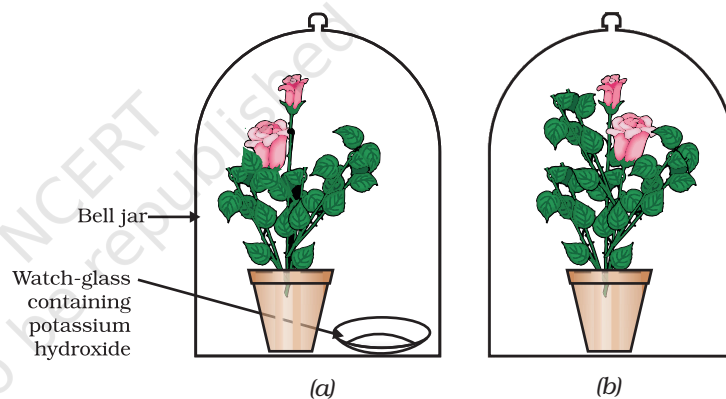

Figure 6.4 Experimental set-up (a) with potassium hydroxide (b) without potassium hydroxide

Based on the two activities performed above, can we design an experiment to demonstrate that sunlight is essential for photosynthesis?

So far, we have talked about how autotrophs meet their energy requirements. But they also need other raw materials for building their body. Water used in photosynthesis is taken up from the soil by the roots in terrestrial plants. Other materials like nitrogen, phosphorus, iron and magnesium are taken up from the soil. Nitrogen is an essential element used in the synthesis of proteins and other compounds. This is

taken up in the form of inorganic nitrates or nitrites. Or it is taken up as organic compounds which have been prepared by bacteria from atmospheric nitrogen.

6.2.2 Heterotrophic Nutrition

Each organism is adapted to its environment. The form of nutrition differs depending on the type and availability of food material as well as how it is obtained by the organism. For example, whether the food source is stationary (such as grass) or mobile (such as a deer), would allow for differences in how the food is accessed and what is the nutritive apparatus used by a cow and a lion. There is a range of strategies by which the food is taken in and used by the organism. Some organisms break-down the food material outside the body and then absorb it. Examples are fungi like bread moulds, yeast and mushrooms. Others take in whole material and break it down inside their bodies. What can be taken in and broken down depends on the body design and functioning. Some other organisms derive nutrition from plants or animals without killing them. This parasitic nutritive strategy is used by a wide variety of organisms like cuscuta (amar-bel), ticks, lice, leeches and tape-worms.

6.2.3 How do Organisms obtain their Nutrition?

Since the food and the way it is obtained differ, the digestive system is different in various organisms. In single-celled organisms, the food may be taken in by the entire surface. But as the complexity of the organism increases, different parts become specialised to perform different functions. For example, *Amoeba* takes in food using temporary finger-like extensions of the cell surface which fuse over the food particle forming a food-vacuole (Fig. 6.5). Inside the food-vacuole, complex substances are broken down into simpler ones which then diffuse into the cytoplasm. The remaining undigested material is moved to the surface of the cell and thrown out. In *Paramecium*, which is also a unicellular organism, the cell has a definite shape and food is taken in at a specific spot. Food is moved to this spot by the movement of cilia which cover the entire surface of the cell.

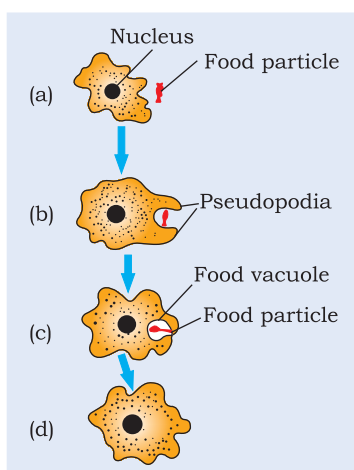

Figure 6.5
Nutrition in *Amoeba*

6.2.4 Nutrition in Human Beings

The alimentary canal is basically a long tube extending from the mouth to the anus. In Fig. 6.6, we can see that the tube has different parts. Various regions are specialised to perform different functions. What happens to the food once it enters our body? We shall discuss this process here.

Activity 6.3

- Take 1 mL starch solution (1%) in two test tubes (A and B).
- Add 1 mL saliva to test tube A and leave both test tubes undisturbed for 20-30 minutes.
- Now add a few drops of dilute iodine solution to the test tubes.
- In which test tube do you observe a colour change?
- What does this indicate about the presence or absence of starch in the two test tubes?
- What does this tell us about the action of saliva on starch?

We eat various types of food which has to pass through the same digestive tract. Naturally the food has to be processed to generate particles which are small and of the same texture. This is achieved by crushing the food with our teeth. Since the lining of the canal is soft, the food is also wetted to make its passage smooth. When we eat something we like, our mouth 'waters'. This is actually not only water, but a fluid called saliva secreted by the salivary glands. Another aspect of the food we ingest is its complex nature. If it is to be absorbed from the alimentary canal, it has to be broken into smaller molecules. This is done with the help of biological catalysts called enzymes. The saliva contains an enzyme called salivary amylase that breaks down starch which is a complex molecule to give simple sugar. The food is mixed thoroughly with saliva and moved around the mouth while chewing by the muscular tongue.

It is necessary to move the food in a regulated manner along the digestive tube so that it can be processed properly in each part. The lining of canal has muscles that contract rhythmically in order to push the food forward. These peristaltic movements occur all along the gut.

From the mouth, the food is taken to the stomach through the food-pipe or oesophagus. The stomach is a large organ which expands when food enters it. The muscular walls of the stomach help in mixing the food thoroughly with more digestive juices.

The digestion in stomach is taken care of by the gastric glands present in the wall of the stomach. These release hydrochloric acid, a protein digesting enzyme called pepsin, and mucus. The hydrochloric acid creates an acidic medium which facilitates the action of the enzyme pepsin. What other function do you think is served by the acid? The mucus protects the inner lining of the stomach from the action of the acid under normal conditions. We

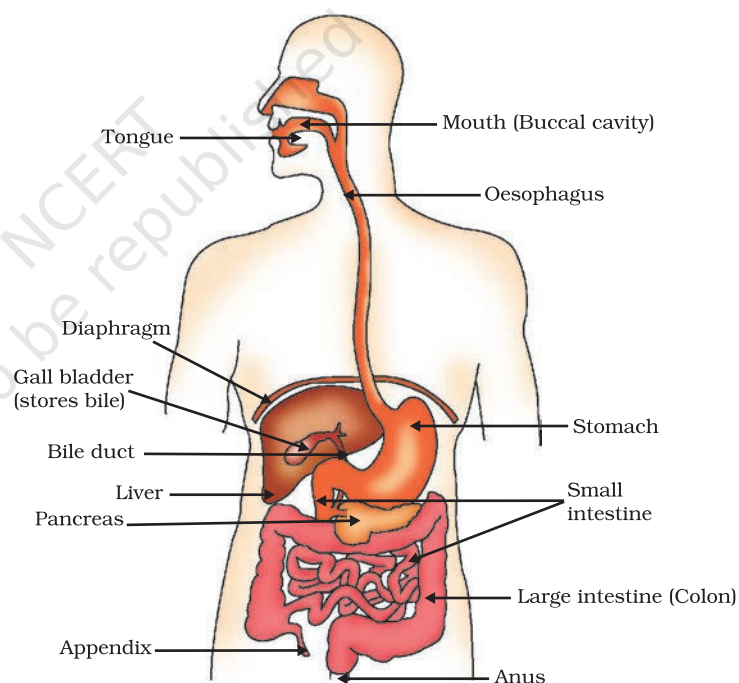

Figure 6.6 Human alimentary canal

have often heard adults complaining about 'acidity'. Can this be related to what has been discussed above?

The exit of food from the stomach is regulated by a sphincter muscle which releases it in small amounts into the small intestine. From the stomach, the food now enters the small intestine. This is the longest part of the alimentary canal which is fitted into a compact space because of extensive coiling. The length of the small intestine differs in various animals depending on the food they eat. Herbivores eating grass need a longer small intestine to allow the cellulose to be digested. Meat is easier to digest, hence carnivores like tigers have a shorter small intestine.

The small intestine is the site of the complete digestion of carbohydrates, proteins and fats. It receives the secretions of the liver and pancreas for this purpose. The food coming from the stomach is acidic and has to be made alkaline for the pancreatic enzymes to act. Bile juice from the liver accomplishes this in addition to acting on fats. Fats are present in the intestine in the form of large globules which makes it difficult for enzymes to act on them. Bile salts break them down into smaller globules increasing the efficiency of enzyme action. This is similar to the emulsifying action of soaps on dirt that we have learnt about in Chapter 4. The pancreas secretes pancreatic juice which contains enzymes like trypsin for digesting proteins and lipase for breaking down emulsified fats. The walls of the small intestine contain glands which secrete intestinal juice. The enzymes present in it finally convert the proteins to amino acids, complex carbohydrates into glucose and fats into fatty acids and glycerol.

Digested food is taken up by the walls of the intestine. The inner lining of the small intestine has numerous finger-like projections called villi which increase the surface area for absorption. The villi are richly supplied with blood vessels which take the absorbed food to each and every cell of the body, where it is utilised for obtaining energy, building up new tissues and the repair of old tissues.

The unabsorbed food is sent into the large intestine where its wall absorb more water from this material. The rest of the material is removed from the body via the anus. The exit of this waste material is regulated by the anal sphincter.

More to Know!

Dental caries

Dental caries or tooth decay causes gradual softening of enamel and dentine. It begins when bacteria acting on sugars produce acids that softens or demineralises the enamel. Masses of bacterial cells together with food particles stick to the teeth to form dental plaque. Saliva cannot reach the tooth surface to neutralise the acid as plaque covers the teeth. Brushing the teeth after eating removes the plaque before the bacteria produce acids. If untreated, microorganisms may invade the pulp, causing inflammation and infection.

Q U E S T I O N S

1. What are the differences between autotrophic nutrition and heterotrophic nutrition?
2. Where do plants get each of the raw materials required for photosynthesis?
3. What is the role of the acid in our stomach?
4. What is the function of digestive enzymes?
5. How is the small intestine designed to absorb digested food?



6.3 RESPIRATION

Activity 6.4

- Take some freshly prepared lime water in a test tube.
- Blow air through this lime water.
- Note how long it takes for the lime water to turn milky.
- Use a syringe or *pichkari* to pass air through some fresh lime water taken in another test tube (Fig. 6.7).
- Note how long it takes for this lime water to turn milky.
- What does this tell us about the amount of carbon dioxide in the air that we breathe out?

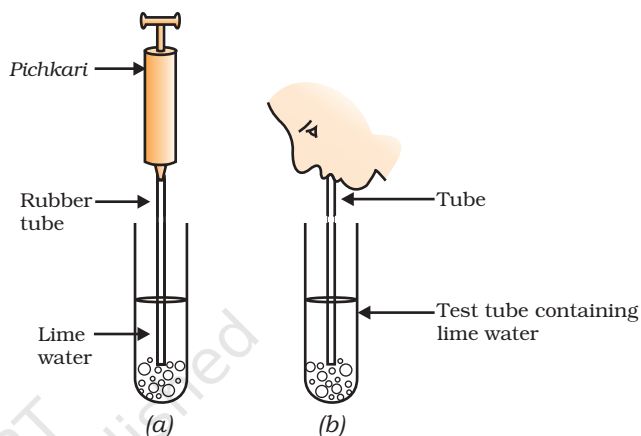

Figure 6.7

(a) Air being passed into lime water with a pichkari/syringe, (b) air being exhaled into lime water

Activity 6.5

- Take some fruit juice or sugar solution and add some yeast to this. Take this mixture in a test tube fitted with a one-holed cork.
- Fit the cork with a bent glass tube. Dip the free end of the glass tube into a test tube containing freshly prepared lime water.
- What change is observed in the lime water and how long does it take for this change to occur?
- What does this tell us about the products of fermentation?

We have discussed nutrition in organisms in the last section. The food material taken in during the process of nutrition is used in cells to provide energy for various life processes. Diverse organisms do this in different ways – some use oxygen to break-down glucose completely into carbon dioxide and water, some use other pathways that do not involve oxygen (Fig. 6.8). In all cases, the first step is the break-down of glucose, a six-carbon molecule, into a three-carbon molecule called pyruvate. This process takes place in the cytoplasm. Further, the pyruvate may be converted into ethanol and carbon dioxide. This process takes place in yeast during fermentation. Since this process takes place in the absence of air (oxygen), it is called anaerobic respiration. Break-down of pyruvate using oxygen takes place in the mitochondria. This

process breaks up the three-carbon pyruvate molecule to give three molecules of carbon dioxide. The other product is water. Since this process takes place in the presence of air (oxygen), it is called aerobic respiration. The release of energy in this aerobic process is a lot greater than in the anaerobic process. Sometimes, when there is a lack of oxygen in our muscle cells, another pathway for the break-down of pyruvate is taken. Here the pyruvate is converted into lactic acid which is also a three-carbon molecule. This build-up of lactic acid in our muscles during sudden activity causes cramps.

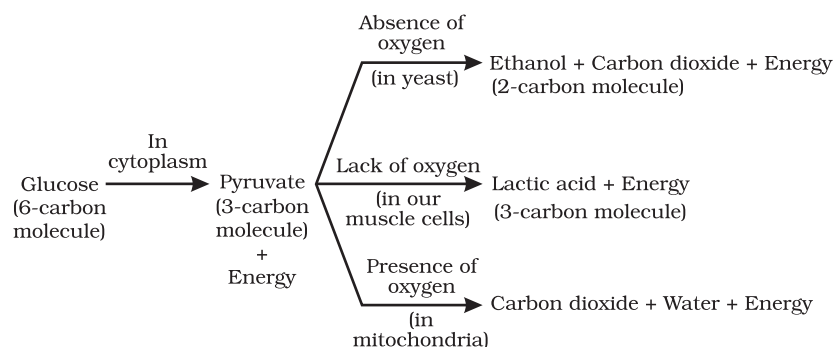

Figure 6.8 Break-down of glucose by various pathways

The energy released during cellular respiration is immediately used to synthesise a molecule called ATP which is used to fuel all other activities in the cell. In these processes, ATP is broken down giving rise to a fixed amount of energy which can drive the endothermic reactions taking place in the cell.

More to Know!

ATP

ATP is the energy currency for most cellular processes. The energy released during the process of respiration is used to make an ATP molecule from ADP and inorganic phosphate.

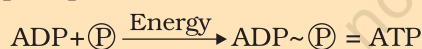

Ⓟ: Phosphate

Endothermic processes in the cell then use this ATP to drive the reactions. When the terminal phosphate linkage in ATP is broken using water, the energy equivalent to 30.5 kJ/mol is released.

Think of how a battery can provide energy for many different kinds of uses. It can be used to obtain mechanical energy, light energy, electrical energy and so on. Similarly, ATP can be used in the cells for the contraction of muscles, protein synthesis, conduction of nervous impulses and many other activities.

Since the aerobic respiration pathway depends on oxygen, aerobic organisms need to ensure that there is sufficient intake of oxygen. We have seen that plants exchange gases through stomata, and the large inter-cellular spaces ensure that all cells are in contact with air. Carbon dioxide and oxygen are exchanged by diffusion here. They can go into

cells, or away from them and out into the air. The direction of diffusion depends upon the environmental conditions and the requirements of the plant. At night, when there is no photosynthesis occurring, CO₂ elimination is the major exchange activity going on. During the day, CO₂ generated during respiration is used up for photosynthesis, hence there is no CO₂ release. Instead, oxygen release is the major event at this time.

Animals have evolved different organs for the uptake of oxygen from the environment and for getting rid of the carbon dioxide produced. Terrestrial animals can breathe the oxygen in the atmosphere, but animals that live in water need to use the oxygen dissolved in water.

Activity 6.6

- Observe fish in an aquarium. They open and close their mouths and the gill-slits (or the operculum which covers the gill-slits) behind their eyes also open and close. Are the timings of the opening and closing of the mouth and gill-slits coordinated in some manner?
- Count the number of times the fish opens and closes its mouth in a minute.
- Compare this to the number of times you breathe in and out in a minute.

Since the amount of dissolved oxygen is fairly low compared to the amount of oxygen in the air, the rate of breathing in aquatic organisms is much faster than that seen in terrestrial organisms. Fishes take in water through their mouths and force it past the gills where the dissolved oxygen is taken up by blood.

Terrestrial organisms use the oxygen in the atmosphere for respiration. This oxygen is absorbed by different organs in different animals. All these organs have a structure that increases the surface area which is in contact with the oxygen-rich atmosphere. Since the exchange of oxygen and carbon dioxide has to take place across this surface, this surface is very fine and delicate. In order to protect this surface, it is usually placed within the body, so there have to be passages that will take air to this area. In addition, there is a mechanism for moving the air in and out of this area where the oxygen is absorbed.

In human beings (Fig. 6.9), air is taken into the body through the nostrils. The air passing through the nostrils is filtered by fine hairs that line the passage. The passage is also lined with mucus which helps in this process. From here, the air passes through the throat and into the lungs. Rings of cartilage are present in the throat. These ensure that the air-passage does not collapse.

More to Know!

Using tobacco directly or any product of tobacco in the form of cigar, cigarettes, *bidis*, *hookah*, *gutkha*, etc., is harmful. Use of tobacco most commonly affects the tongue, lungs, heart and liver. Smokeless tobacco is also a major risk factor for heart attacks, strokes, pulmonary diseases and several forms of cancers. There is a high incidence of oral cancer in India due to the chewing of tobacco in the form of *gutkha*. Stay healthy; just say NO to tobacco and its products!

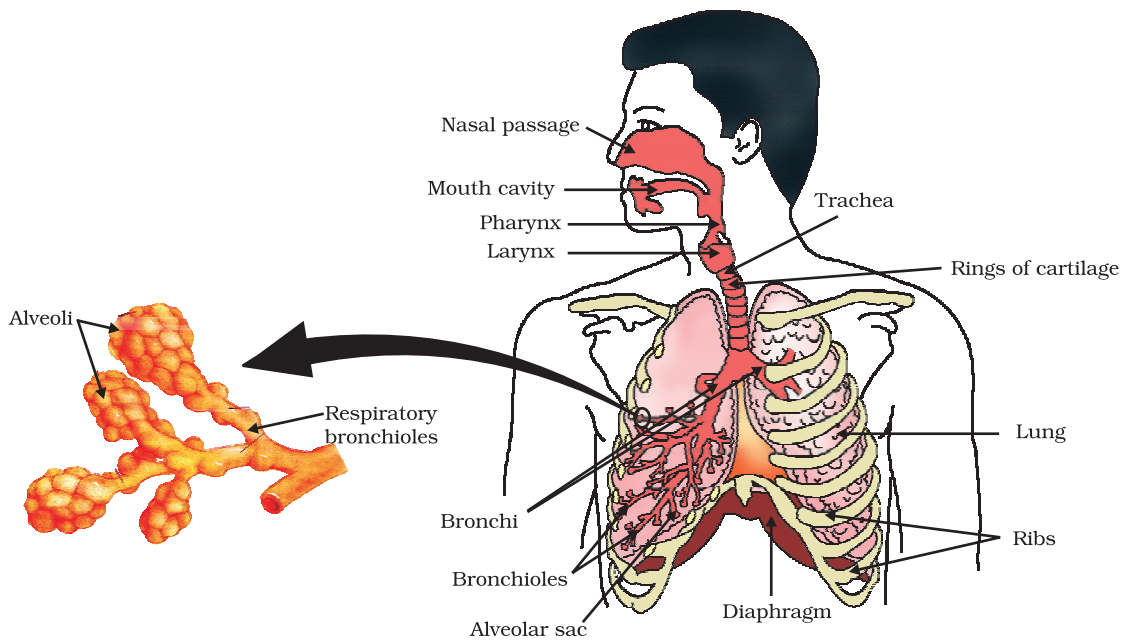

Figure 6.9 Human respiratory system

Do You Know?

Smoking is injurious to health.

Lung cancer is one of common causes of deaths in the world. The upper part of respiratory tract is provided with small hair-like structures called cilia. These cilia help to remove germs, dust and other harmful particles from inhaled air. Smoking destroys these hair due to which germs, dust, smoke and other harmful chemicals enter lungs and cause infection, cough and even lung cancer.

Within the lungs, the passage divides into smaller and smaller tubes which finally terminate in balloon-like structures which are called alveoli (singular–alveolus). The alveoli provide a surface where the exchange of gases can take place. The walls of the alveoli contain an extensive network of blood-vessels. As we have seen in earlier years, when we breathe in, we lift our ribs and flatten our diaphragm, and the chest cavity becomes larger as a result. Because of this, air is sucked into the lungs and fills the expanded alveoli. The blood brings carbon dioxide from the rest of the body for release into the alveoli, and the oxygen in the alveolar air is taken up by blood in the alveolar blood vessels to be transported to all the cells in the body. During the breathing cycle, when air is taken in and let out, the lungs always contain a residual volume of air so that there is sufficient time for oxygen to be absorbed and for the carbon dioxide to be released.

When the body size of animals is large, the diffusion pressure alone cannot take care of oxygen delivery to all parts of the body. Instead, respiratory pigments take up oxygen from the air in the lungs and carry it to tissues which are deficient in oxygen before releasing it. In human beings, the respiratory pigment is haemoglobin which has a very high affinity for oxygen. This pigment is present in the red blood corpuscles. Carbon dioxide is more soluble in water than oxygen is and hence is mostly transported in the dissolved form in our blood.

Do You Know?

- If the alveolar surface were spread out, it would cover about 80 m². How much do you think the surface area of your body is? Consider how efficient exchange of gases becomes because of the large surface available for the exchange to take place.
- If diffusion were to move oxygen in our body, it is estimated that it would take 3 years for a molecule of oxygen to get to our toes from our lungs. Aren't you glad that we have haemoglobin?

Q U E S T I O N S

1. What advantage over an aquatic organism does a terrestrial organism have with regard to obtaining oxygen for respiration?
2. What are the different ways in which glucose is oxidised to provide energy in various organisms?
3. How is oxygen and carbon dioxide transported in human beings?
4. How are the lungs designed in human beings to maximise the area for exchange of gases?



6.4 TRANSPORTATION

6.4.1 Transportation in Human Beings

Activity 6.7

- Visit a health centre in your locality and find out what is the normal range of haemoglobin content in human beings.
- Is it the same for children and adults?
- Is there any difference in the haemoglobin levels for men and women?
- Visit a veterinary clinic in your locality. Find out what is the normal range of haemoglobin content in an animal like the buffalo or cow.
- Is this content different in calves, male and female animals?
- Compare the difference seen in male and female human beings and animals.
- How would the difference, if any, be explained?

We have seen in previous sections that blood transports food, oxygen and waste materials in our bodies. In Class IX, we learnt about blood being a fluid connective tissue. Blood consists of a fluid medium called plasma in which the cells are suspended. Plasma transports food, carbon dioxide and nitrogenous wastes in dissolved form. Oxygen is carried by the red blood corpuscles. Many other substances like salts, are also transported by the blood. We thus need a pumping organ to push blood around the body, a network of tubes to reach all the tissues and a system in place to ensure that this network can be repaired if damaged.

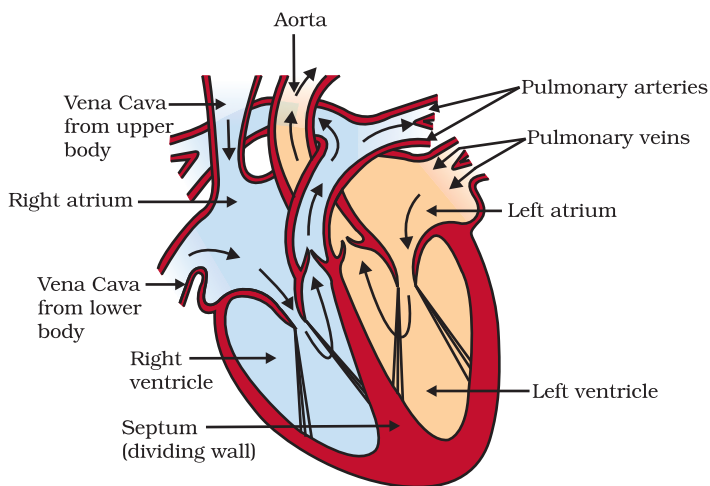

Figure 6.10
Schematic sectional view of the human heart

chamber of the heart on the left, the left atrium. The left atrium relaxes when it is collecting this blood. It then contracts, while the next chamber, the left ventricle, relaxes, so that the blood is transferred to it. When the muscular left ventricle contracts in its turn, the blood is pumped out to the body. De-oxygenated blood comes from the body to the upper chamber on the right, the right atrium, as it relaxes. As the right atrium contracts, the corresponding lower chamber, the right ventricle, dilates. This transfers blood to the right ventricle, which in turn pumps it to the lungs for oxygenation. Since ventricles have to pump blood into various organs, they have thicker muscular walls than the atria do. Valves ensure that blood does not flow backwards when the atria or ventricles contract.

Our pump — the heart

The heart is a muscular organ which is as big as our fist (Fig. 6.10). Because both oxygen and carbon dioxide have to be transported by the blood, the heart has different chambers to prevent the oxygen-rich blood from mixing with the blood containing carbon dioxide. The carbon dioxide-rich blood has to reach the lungs for the carbon dioxide to be removed, and the oxygenated blood from the lungs has to be brought back to the heart. This oxygen-rich blood is then pumped to the rest of the body.

We can follow this process step by step (Fig. 6.11). Oxygen-rich blood from the lungs comes to the thin-walled upper

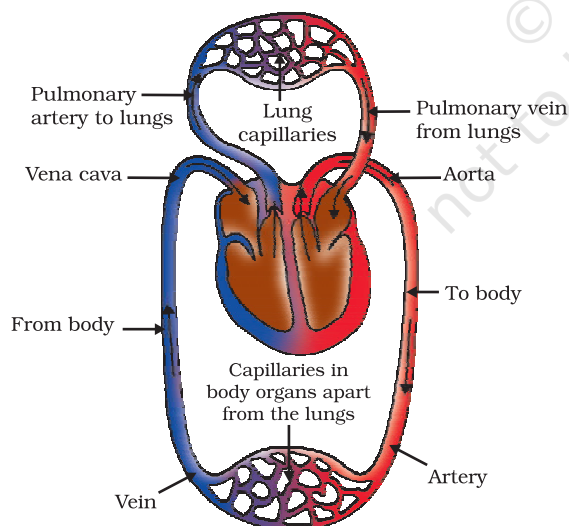

Figure 6.11
Schematic representation of transport and exchange of oxygen and carbon dioxide

Oxygen enters the blood in the lungs

The separation of the right side and the left side of the heart is useful to keep oxygenated and de-oxygenated blood from mixing. Such separation allows a highly efficient supply of oxygen to the body. This is useful in animals that have high energy needs, such as birds and mammals, which constantly use energy to maintain their body temperature. In animals that do not use energy for this purpose, the body temperature depends on the temperature in the environment. Such animals, like amphibians or many reptiles have three-chambered hearts, and tolerate some mixing of the oxygenated and de-oxygenated blood streams. Fishes, on the other hand, have only two chambers to their hearts, and the blood is pumped to the gills, is oxygenated there, and passes directly to the rest of the body. Thus, blood goes only once through the heart in the fish during one cycle of

passage through the body. On the other hand, it goes through the heart twice during each cycle in other vertebrates. This is known as double circulation.

Blood pressure

The force that blood exerts against the wall of a vessel is called blood pressure. This pressure is much greater in arteries than in veins. The pressure of blood inside the artery during ventricular systole (contraction) is called systolic pressure and pressure in artery during ventricular diastole (relaxation) is called diastolic pressure. The normal systolic pressure is about 120 mm of Hg and diastolic pressure is 80 mm of Hg.

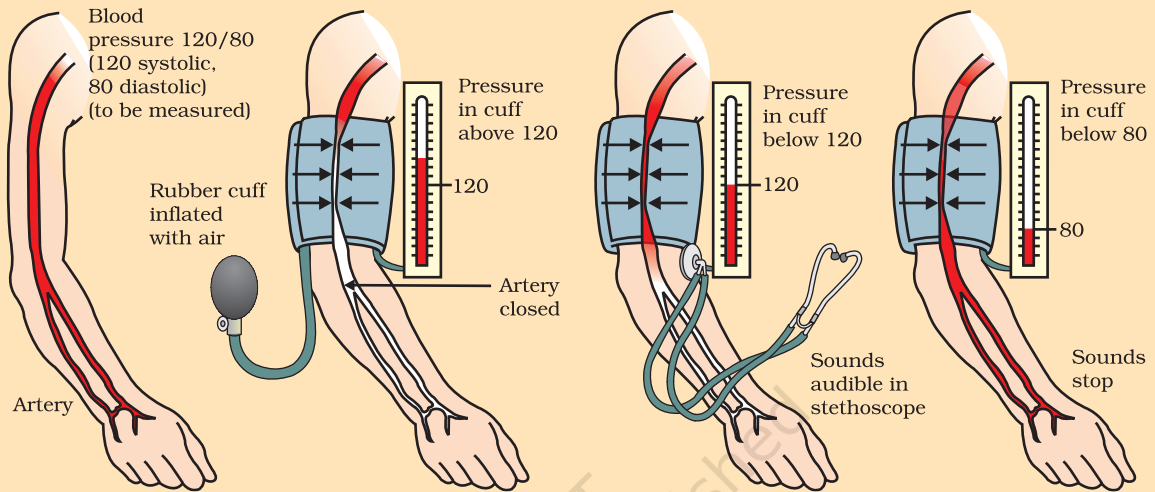

Blood pressure is measured with an instrument called sphygmomanometer. High blood pressure is also called hypertension and is caused by the constriction of arterioles, which results in increased resistance to blood flow. It can lead to the rupture of an artery and internal bleeding.

The tubes – blood vessels

Arteries are the vessels which carry blood away from the heart to various organs of the body. Since the blood emerges from the heart under high pressure, the arteries have thick, elastic walls. Veins collect the blood from different organs and bring it back to the heart. They do not need thick walls because the blood is no longer under pressure, instead they have valves that ensure that the blood flows only in one direction.

On reaching an organ or tissue, the artery divides into smaller and smaller vessels to bring the blood in contact with all the individual cells. The smallest vessels have walls which are one-cell thick and are called capillaries. Exchange of material between the blood and surrounding cells takes place across this thin wall. The capillaries then join together to form veins that convey the blood away from the organ or tissue.

Maintenance by platelets

What happens if this system of tubes develops a leak? Think about situations when we are injured and start bleeding. Naturally the loss of blood from the system has to be minimised. In addition, leakage would lead to a loss of pressure which would reduce the efficiency of the

pumping system. To avoid this, the blood has platelet cells which circulate around the body and plug these leaks by helping to clot the blood at these points of injury.

Lymph

There is another type of fluid also involved in transportation. This is called lymph or tissue fluid. Through the pores present in the walls of capillaries some amount of plasma, proteins and blood cells escape into intercellular spaces in the tissues to form the tissue fluid or lymph. It is similar to the plasma of blood but colourless and contains less protein. Lymph drains into lymphatic capillaries from the intercellular spaces, which join to form large lymph vessels that finally open into larger veins. Lymph carries digested and absorbed fat from intestine and drains excess fluid from extra cellular space back into the blood.

6.4.2 Transportation in Plants

We have discussed earlier how plants take in simple compounds such as CO_2 and photosynthesise energy stored in their chlorophyll-containing organs, namely leaves. The other kinds of raw materials needed for building plant bodies will also have to be taken up separately. For plants, the soil is the nearest and richest source of raw materials like nitrogen, phosphorus and other minerals. The absorption of these substances therefore occurs through the part in contact with the soil, namely roots. If the distances between soil-contacting organs and chlorophyll-containing organs are small, energy and raw materials can easily diffuse to all parts of the plant body. But if these distances become large because of changes in plant body design, diffusion processes will not be sufficient to provide raw material in leaves and energy in roots. A proper system of transportation is therefore essential in such situations.

Energy needs differ between different body designs. Plants do not move, and plant bodies have a large proportion of dead cells in many tissues. As a result, plants have low energy needs, and can use relatively slow transport systems. The distances over which transport systems have to operate, however, can be very large in plants such as very tall trees.

Plant transport systems will move energy stores from leaves and raw materials from roots. These two pathways are constructed as independently organised conducting tubes. One, the xylem moves water and minerals obtained from the soil. The other, phloem transports products of photosynthesis from the leaves where they are synthesised to other parts of the plant. We have studied the structure of these tissues in detail in Class IX.

Transport of water

In xylem tissue, vessels and tracheids of the roots, stems and leaves are interconnected to form a continuous system of water-conducting channels reaching all parts of the plant. At the roots, cells in contact with the soil actively take up ions. This creates a difference in the concentration of these ions between the root and the soil. Water, therefore,

moves into the root from the soil to eliminate this difference. This means that there is steady movement of water into root xylem, creating a column of water that is steadily pushed upwards.

However, this pressure by itself is unlikely to be enough to move water over the heights that we commonly see in plants. Plants use another strategy to move water in the xylem upwards to the highest points of the plant body.

Activity 6.8

- Take two small pots of approximately the same size and having the same amount of soil. One should have a plant in it. Place a stick of the same height as the plant in the other pot.
- Cover the soil in both pots with a plastic sheet so that moisture cannot escape by evaporation.
- Cover both sets, one with the plant and the other with the stick, with plastic sheets and place in bright sunlight for half an hour.
- Do you observe any difference in the two cases?

Provided that the plant has an adequate supply of water, the water which is lost through the stomata is replaced by water from the xylem vessels in the leaf. In fact, evaporation of water molecules from the cells of a leaf creates a suction which pulls water from the xylem cells of roots. The loss of water in the form of vapour from the aerial parts of the plant is known as transpiration.

Thus, transpiration helps in the absorption and upward movement of water and minerals dissolved in it from roots to the leaves. It also helps in temperature regulation. The effect of root pressure in transport of water is more important at night. During the day when the stomata are open, the transpiration pull becomes the major driving force in the movement of water in the xylem.

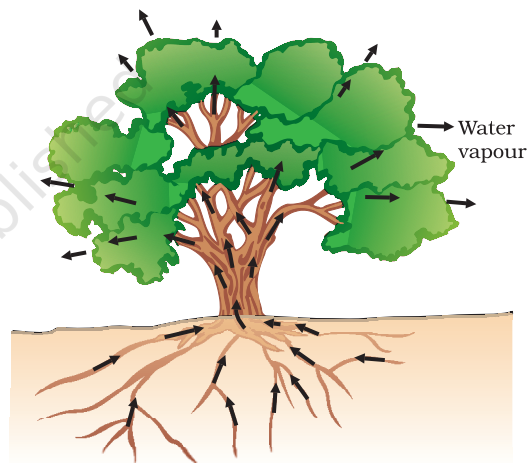

Figure 6.12

Movement of water during transpiration in a tree

Transport of food and other substances

So far we have discussed the transport of water and minerals in plants. Now let us consider how the products of metabolic processes, particularly photosynthesis, are moved from leaves, where they are formed, to other parts of the plant. This transport of soluble products of photosynthesis is called translocation and it occurs in the part of the vascular tissue known as phloem. Besides the products of photosynthesis, the phloem transports amino acids and other substances. These substances are especially delivered to the storage organs of roots, fruits and seeds and to growing organs. The translocation of food and other substances takes place in the sieve tubes with the help of adjacent companion cells both in upward and downward directions.

Unlike transport in xylem which can be largely explained by simple physical forces, the translocation in phloem is achieved by utilising

energy. Material like sucrose is transferred into phloem tissue using energy from ATP. This increases the osmotic pressure of the tissue causing water to move into it. This pressure moves the material in the phloem to tissues which have less pressure. This allows the phloem to move material according to the plant's needs. For example, in the spring, sugar stored in root or stem tissue would be transported to the buds which need energy to grow.

Q U E S T I O N S

1. What are the components of the transport system in human beings? What are the functions of these components?
2. Why is it necessary to separate oxygenated and deoxygenated blood in mammals and birds?
3. What are the components of the transport system in highly organised plants?
4. How are water and minerals transported in plants?
5. How is food transported in plants?



6.5 EXCRETION

We have already discussed how organisms get rid of gaseous wastes generated during photosynthesis or respiration. Other metabolic activities generate nitrogenous materials which need to be removed. The biological process involved in the removal of these harmful metabolic wastes from the body is called excretion. Different organisms use varied strategies to do this. Many unicellular organisms remove these wastes by simple diffusion from the body surface into the surrounding water. As we have seen in other processes, complex multi-cellular organisms use specialised organs to perform the same function.

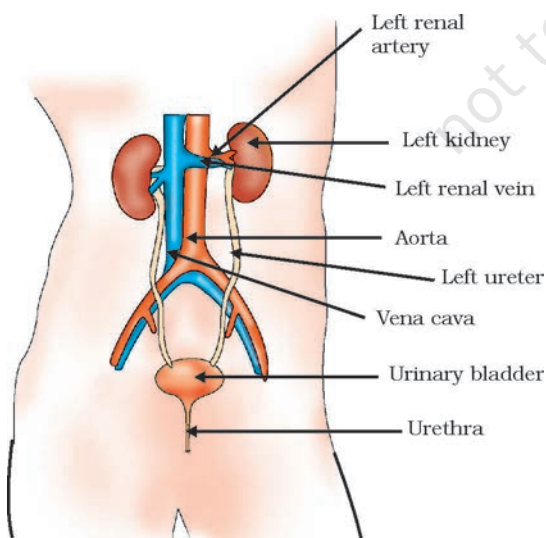

Figure 6.13
Excretory system in human beings

6.5.1 Excretion in Human Beings

The excretory system of human beings (Fig. 6.13) includes a pair of kidneys, a pair of ureters, a urinary bladder and a urethra. Kidneys are located in the abdomen, one on either side of the backbone. Urine produced in the kidneys passes through the ureters into the urinary bladder where it is stored until it is released through the urethra.

How is urine produced? The purpose of making urine is to filter out waste products from the blood. Just as CO_2 is removed from the blood in the lungs, nitrogenous waste such as urea or uric acid are removed from blood in the kidneys. It is no surprise that the basic filtration unit in the kidneys,

like in the lungs, is a cluster of very thin-walled blood capillaries. Each capillary cluster in the kidney is associated with the cup-shaped end of a coiled tube called Bowman's capsule that collects the filtrate (Fig. 6.14). Each kidney has large numbers of these filtration units called nephrons packed close together. Some substances in the initial filtrate, such as glucose, amino acids, salts and a major amount of water, are selectively re-absorbed as the urine flows along the tube. The amount of water re-absorbed depends on how much excess water there is in the body, and on how much of dissolved waste there is to be excreted. The urine forming in each kidney eventually enters a long tube, the ureter, which connects the kidneys with the urinary bladder. Urine is stored in the urinary bladder until the pressure of the expanded bladder leads to the urge to pass it out through the urethra. The bladder is muscular, so it is under nervous control, as we have discussed elsewhere. As a result, we can usually control the urge to urinate.

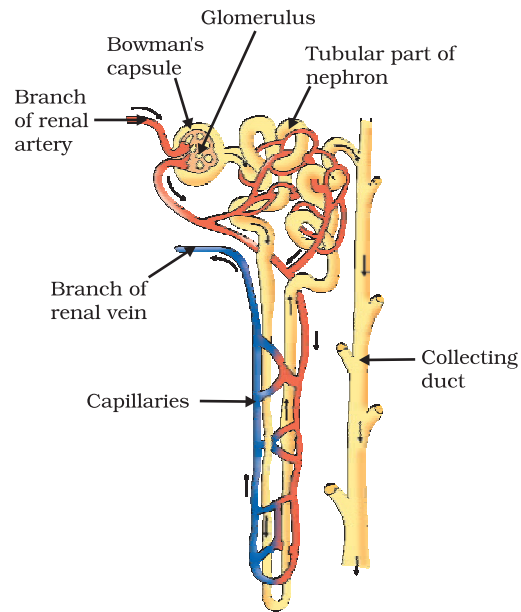

Figure 6.14
Structure of a nephron

More to Know!

Artificial kidney (Hemodialysis)

Kidneys are vital organs for survival. Several factors like infections, injury or restricted blood flow to kidneys reduce the activity of kidneys. This leads to accumulation of poisonous wastes in the body, which can even lead to death. In case of kidney failure, an artificial kidney can be used. An artificial kidney is a device to remove nitrogenous waste products from the blood through *dialysis*.

Artificial kidneys contain a number of tubes with a semi-permeable lining, suspended in a tank filled with dialysing fluid.

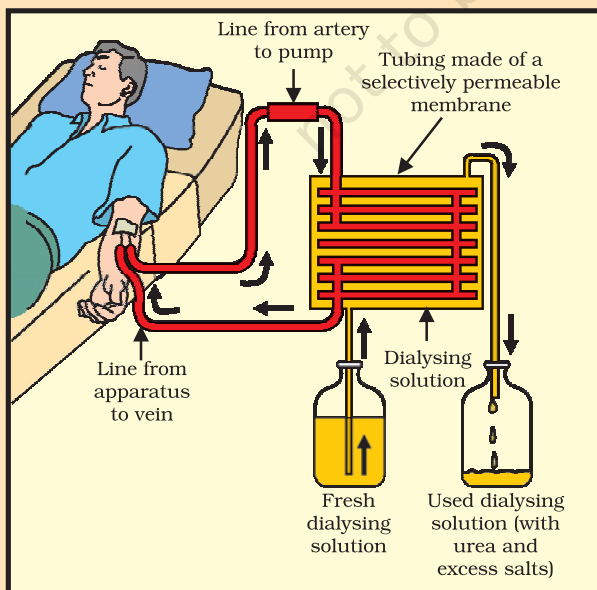

This fluid has the same osmotic pressure as blood, except that it is devoid of nitrogenous wastes. The patient's blood is passed through these tubes. During this passage, the waste products from the blood pass into dialysing fluid by diffusion. The purified blood is pumped back into the patient. This is similar to the function of the kidney, but it is different since there is no re-absorption involved. Normally, in a healthy adult, the initial filtrate in the kidneys is about 180 L daily. However, the volume actually excreted is only a litre or two a day, because the remaining filtrate is re-absorbed in the kidney tubules.

Think it over!

Organ donation

Organ donation is a generous act of donating an organ to a person who suffers from non-function of organ(s). Donation of an organ may be done by the consent of the donor and his/her family. Anyone regardless of age or gender can become an organ and tissue donor. Organ transplants can save or transform the life of a person. Transplantation is required because recipient's organ has been damaged or has failed by disease or injury. In organ transplantation the organ is surgically removed from one person (organ donor) and transplanted to another person (the recipient). Common transplantations include corneas, kidneys, heart, liver, pancreas, lungs, intestines and bone marrow. Most organ and tissue donations occur just after the donor has died or when the doctor declares a person brain dead. But some organs such as kidney, part of a liver, lung, etc., and tissues can be donated while the donor is alive.

6.5.2 Excretion in Plants

Plants use completely different strategies for excretion than those of animals. Oxygen itself can be thought of as a waste product generated during photosynthesis! We have discussed earlier how plants deal with oxygen as well as CO_2 . They can get rid of excess water by transpiration. For other wastes, plants use the fact that many of their tissues consist of dead cells, and that they can even lose some parts such as leaves. Many plant waste products are stored in cellular vacuoles. Waste products may be stored in leaves that fall off. Other waste products are stored as resins and gums, especially in old xylem. Plants also excrete some waste substances into the soil around them.

Q U E S T I O N S

1. Describe the structure and functioning of nephrons.
2. What are the methods used by plants to get rid of excretory products?
3. How is the amount of urine produced regulated?



What you have learnt

- Movement of various types can be taken as an indication of life.
- Maintenance of life requires processes like nutrition, respiration, transport of materials within the body and excretion of waste products.
- Autotrophic nutrition involves the intake of simple inorganic materials from the environment and using an external energy source like the Sun to synthesise complex high-energy organic material.
- Heterotrophic nutrition involves the intake of complex material prepared by other organisms.
- In human beings, the food eaten is broken down by various steps along the alimentary canal and the digested food is absorbed in the small intestine to be sent to all cells in the body.

- During the process of respiration, organic compounds such as glucose are broken down to provide energy in the form of ATP. ATP is used to provide energy for other reactions in the cell.
- Respiration may be aerobic or anaerobic. Aerobic respiration makes more energy available to the organism.
- In human beings, the transport of materials such as oxygen, carbon dioxide, food and excretory products is a function of the circulatory system. The circulatory system consists of the heart, blood and blood vessels.
- In highly differentiated plants, transport of water, minerals, food and other materials is a function of the vascular tissue which consists of xylem and phloem.
- In human beings, excretory products in the form of soluble nitrogen compounds are removed by the nephrons in the kidneys.
- Plants use a variety of techniques to get rid of waste material. For example, waste material may be stored in the cell-vacuoles or as gum and resin, removed in the falling leaves, or excreted into the surrounding soil.

E X E R C I S E S

1. The kidneys in human beings are a part of the system for

(a) nutrition.	(c) excretion.
(b) respiration.	(d) transportation.
2. The xylem in plants are responsible for

(a) transport of water.	(c) transport of amino acids.
(b) transport of food.	(d) transport of oxygen.
3. The autotrophic mode of nutrition requires

(a) carbon dioxide and water.	(c) sunlight.
(b) chlorophyll.	(d) all of the above.
4. The breakdown of pyruvate to give carbon dioxide, water and energy takes place in

(a) cytoplasm.	(c) chloroplast.
(b) mitochondria.	(d) nucleus.
5. How are fats digested in our bodies? Where does this process take place?
6. What is the role of saliva in the digestion of food?
7. What are the necessary conditions for autotrophic nutrition and what are its by-products?
8. What are the differences between aerobic and anaerobic respiration? Name some organisms that use the anaerobic mode of respiration.
9. How are the alveoli designed to maximise the exchange of gases?
10. What would be the consequences of a deficiency of haemoglobin in our bodies?
11. Describe double circulation of blood in human beings. Why is it necessary?
12. What are the differences between the transport of materials in xylem and phloem?
13. Compare the functioning of alveoli in the lungs and nephrons in the kidneys with respect to their structure and functioning.



1064CH07

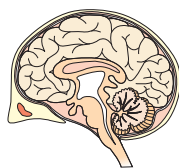

CHAPTER 7

Control and Coordination

In the previous chapter, we looked at life processes involved in the maintenance functions in living organisms. There, we had started with a notion we all have, that if we see something moving, it is alive. Some of these movements are in fact the result of growth, as in plants. A seed germinates and grows, and we can see that the seedling moves over the course of a few days, it pushes soil aside and comes out. But if its growth were to be stopped, these movements would not happen. Some movements, as in many animals and some plants, are not connected with growth. A cat running, children playing on swings, buffaloes chewing cud – these are not movements caused by growth.

Why do we associate such visible movements with life? A possible answer is that we think of movement as a response to a change in the environment of the organism. The cat may be running because it has seen a mouse. Not only that, we also think of movement as an attempt by living organisms to use changes in their environment to their advantage. Plants grow out into the sunshine. Children try to get pleasure and fun out of swinging. Buffaloes chew cud to help break up tough food so as to be able to digest it better. When bright light is focussed on our eyes or when we touch a hot object, we detect the change and respond to it with movement in order to protect ourselves.

If we think a bit more about this, it becomes apparent that all this movement, in response to the environment, is carefully controlled. Each kind of a change in the environment evokes an appropriate movement in response. When we want to talk to our friends in class, we whisper, rather than shouting loudly. Clearly, the movement to be made depends on the event that is triggering it. Therefore, such controlled movement must be connected to the recognition of various events in the environment, followed by only the correct movement in response. In other words, living organisms must use systems providing control and coordination. In keeping with the general principles of body organisation in multicellular organisms, specialised tissues are used to provide these control and coordination activities.

7.1 ANIMALS – NERVOUS SYSTEM

In animals, such control and coordination are provided by nervous and muscular tissues, which we have studied in Class IX. Touching a hot

object is an urgent and dangerous situation for us. We need to detect it, and respond to it. How do we detect that we are touching a hot object? All information from our environment is detected by the specialised tips of some nerve cells. These receptors are usually located in our sense organs, such as the inner ear, the nose, the tongue, and so on. So gustatory receptors will detect taste while olfactory receptors will detect smell.

This information, acquired at the end of the dendritic tip of a nerve cell [Fig. 7.1 (a)], sets off a chemical reaction that creates an electrical impulse. This impulse travels from the dendrite to the cell body, and then along the axon to its end. At the end of the axon, the electrical impulse sets off the release of some chemicals. These chemicals cross the gap, or synapse, and start a similar electrical impulse in a dendrite of the next neuron. This is a general scheme of how nervous impulses travel in the body. A similar synapse finally allows delivery of such impulses from neurons to other cells, such as muscles cells or gland [Fig. 7.1 (b)].

It is thus no surprise that nervous tissue is made up of an organised network of nerve cells or neurons, and is specialised for conducting information via electrical impulses from one part of the body to another.

Look at Fig. 7.1 (a) and identify the parts of a neuron (i) where information is acquired, (ii) through which information travels as an electrical impulse, and (iii) where this impulse must be converted into a chemical signal for onward transmission.

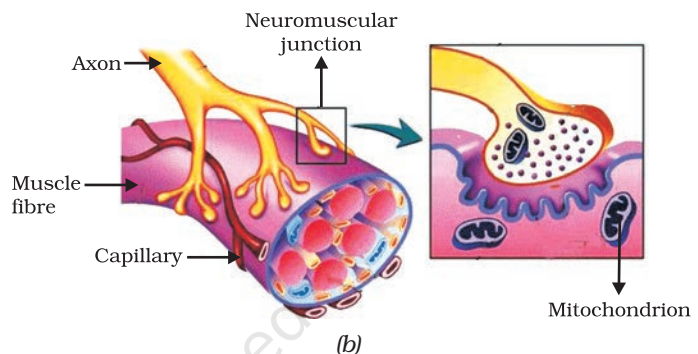
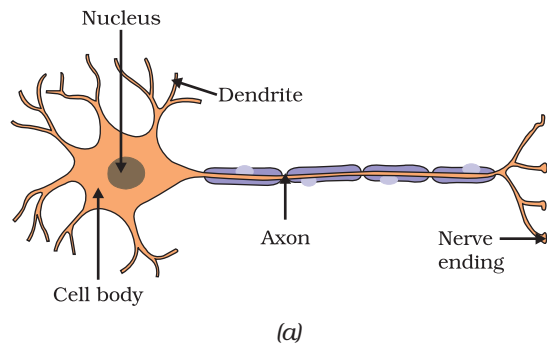

Figure 7.1 (a) Structure of neuron, (b) Neuromuscular junction

Activity 7.1

- Put some sugar in your mouth. How does it taste?
- Block your nose by pressing it between your thumb and index finger. Now eat sugar again. Is there any difference in its taste?
- While eating lunch, block your nose in the same way and notice if you can fully appreciate the taste of the food you are eating.

Is there a difference in how sugar and food taste if your nose is blocked? If so, why might this be happening? Read and talk about possible explanations for these kinds of differences. Do you come across a similar situation when you have a cold?

7.1.1 What happens in Reflex Actions?

'Reflex' is a word we use very commonly when we talk about some sudden action in response to something in the environment. We say 'I jumped out of the way of the bus reflexly', or 'I pulled my hand back from the flame reflexly', or 'I was so hungry my mouth started watering reflexly'. What exactly do we mean? A common idea in all such examples is that we do something without thinking about it, or without feeling in control of our reactions. Yet these are situations where we are responding with some action to changes in our environment. How is control and coordination achieved in such situations?

Let us consider this further. Take one of our examples. Touching a flame is an urgent and dangerous situation for us, or in fact, for any animal! How would we respond to this? One seemingly simple way is to think consciously about the pain and the possibility of getting burnt, and therefore move our hand. An important question then is, how long will it take us to think all this? The answer depends on how we think. If nerve impulses are sent around the way we have talked about earlier, then thinking is also likely to involve the creation of such impulses. Thinking is a complex activity, so it is bound to involve a complicated interaction of many nerve impulses from many neurons.

If this is the case, it is no surprise that the thinking tissue in our body consists of dense networks of intricately arranged neurons. It sits in the forward end of the skull, and receives signals from all over the body which it thinks about before responding to them. Obviously, in order to receive these signals, this thinking part of the brain in the skull must be connected to nerves coming from various parts of the body. Similarly, if this part of the brain is to instruct muscles to move, nerves must carry this signal back to different parts of the body. If all of this is to be done when we touch a hot object, it may take enough time for us to get burnt!

How does the design of the body solve this problem? Rather than having to think about the sensation of heat, if the nerves that detect heat were to be connected to the nerves that move muscles in a simpler way, the process of detecting the signal or the input and responding to it by an output action might be completed quickly. Such a connection is commonly called a reflex arc (Fig. 7.2). Where should such reflex arc connections be made between the input nerve and the output nerve? The best place, of course, would be at the point where they first meet each other. Nerves from all over the body meet in a bundle in the spinal cord on their way to the brain. Reflex arcs are formed in this spinal cord itself, although the information input also goes on to reach the brain.

Of course, reflex arcs have evolved in animals because the thinking process of the brain is not fast enough. In fact many animals have very little or none of the complex neuron network needed for thinking. So it is quite likely that reflex arcs have evolved as efficient ways of functioning in the absence of true thought processes. However, even after complex neuron networks have come into existence, reflex arcs continue to be more efficient for quick responses.

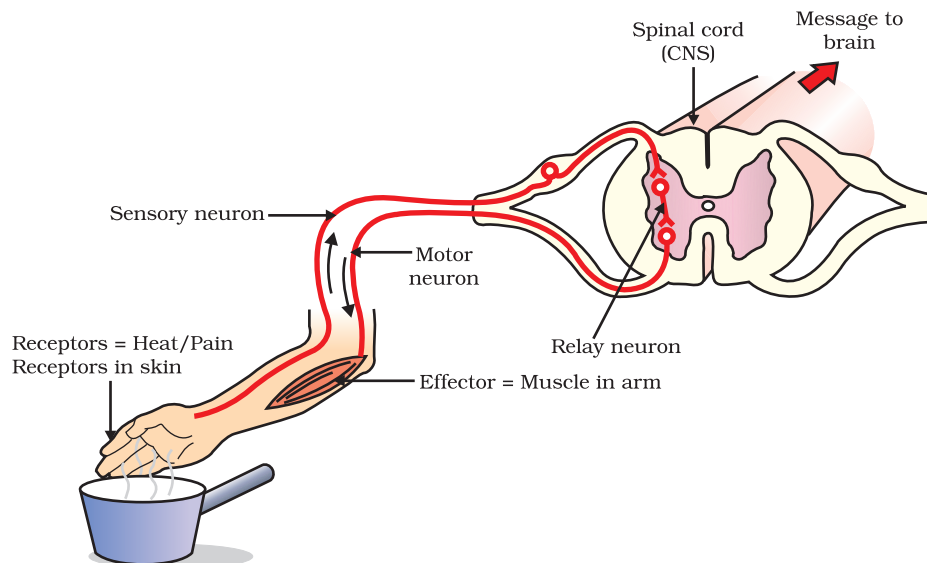

Figure 7.2 Reflex arc

Can you now trace the sequence of events which occur when a bright light is focussed on your eyes?

7.1.2 Human Brain

Is reflex action the only function of the spinal cord? Obviously not, since we know that we are thinking beings. Spinal cord is made up of nerves which supply information to think about. Thinking involves more complex mechanisms and neural connections. These are concentrated in the brain, which is the main coordinating centre of the body. The brain and spinal cord constitute the central nervous system. They receive information from all parts of the body and integrate it.

We also think about our actions. Writing, talking, moving a chair, clapping at the end of a programme are examples of voluntary actions which are based on deciding what to do next. So, the brain also has to send messages to muscles. This is the second way in which the nervous system communicates with the muscles. The communication between the central nervous system and the other parts of the body is facilitated by the peripheral nervous system consisting of cranial nerves arising from the brain and spinal nerves arising from the spinal cord. The brain thus allows us to think and take actions based on that thinking. As you will expect, this is accomplished through a complex design, with different parts of the brain responsible for integrating different inputs and outputs. The brain has three such major parts or regions, namely the fore-brain, mid-brain and hind-brain.

The fore-brain is the main thinking part of the brain. It has regions which receive sensory impulses from various receptors. Separate areas of the fore-brain are specialised for hearing, smell, sight and so on. There are separate areas of association where this sensory information is interpreted by putting it together with information from other receptors as well as with information that is already stored in the brain. Based on

all this, a decision is made about how to respond and the information is passed on to the motor areas which control the movement of voluntary muscles, for example, our leg muscles. However, certain sensations are distinct from seeing or hearing, for example, how do we know that we have eaten enough? The sensation of feeling full is because of a centre associated with hunger, which is in a separate part of the fore-brain.

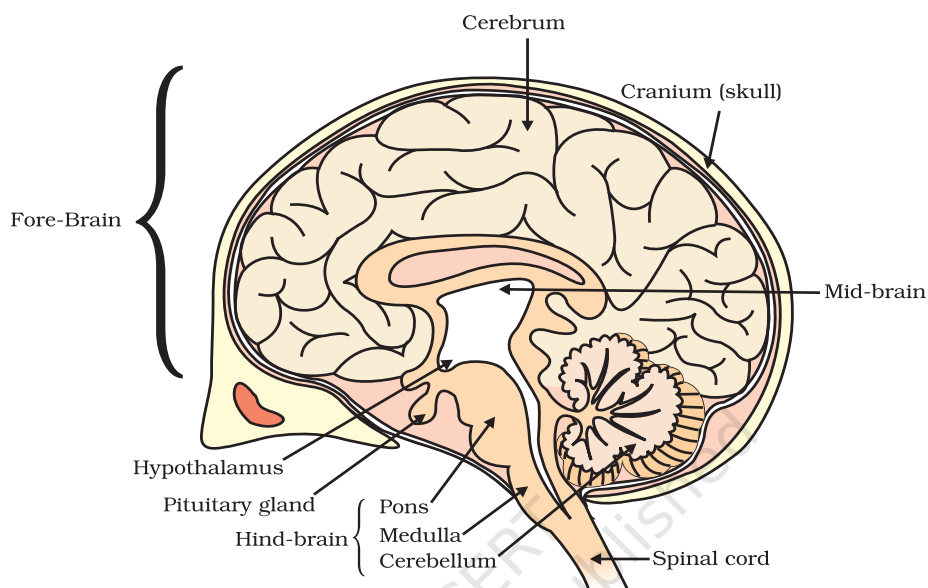

Figure 7.3 Human brain

Study the labelled diagram of the human brain. We have seen that the different parts have specific functions. Can we find out the function of each part?

Let us look at the other use of the word 'reflex' that we have talked about in the introduction. Our mouth waters when we see food we like without our meaning to. Our hearts beat without our thinking about it. In fact, we cannot control these actions easily by thinking about them even if we wanted to. Do we have to think about or remember to breathe or digest food? So, in between the simple reflex actions like change in the size of the pupil, and the thought out actions such as moving a chair, there is another set of muscle movements over which we do not have any thinking control. Many of these involuntary actions are controlled by the mid-brain and hind-brain. All these involuntary actions including blood pressure, salivation and vomiting are controlled by the medulla in the hind-brain.

Think about activities like walking in a straight line, riding a bicycle, picking up a pencil. These are possible due to a part of the hind-brain called the cerebellum. It is responsible for precision of voluntary actions and maintaining the posture and balance of the body. Imagine what would happen if each of these events failed to take place if we were not thinking about it.

7.1.3 How are these Tissues protected?

A delicate organ like the brain, which is so important for a variety of activities, needs to be carefully protected. For this, the body is designed so that the brain sits inside a bony box. Inside the box, the brain is contained in a fluid-filled balloon which provides further shock absorption. If you run your hand down the middle of your back, you will feel a hard, bumpy structure. This is the vertebral column or backbone which protects the spinal cord.

7.1.4 How does the Nervous Tissue cause Action?

So far, we have been talking about nervous tissue, and how it collects information, sends it around the body, processes information, makes decisions based on information, and conveys decisions to muscles for action. In other words, when the action or movement is to be performed, muscle tissue will do the final job. How do animal muscles move? When a nerve impulse reaches the muscle, the muscle fibre must move. How does a muscle cell move? The simplest notion of movement at the cellular level is that muscle cells will move by changing their shape so that they shorten. So the next question is, how do muscle cells change their shape? The answer must lie in the chemistry of cellular components. Muscle cells have special proteins that change both their shape and their arrangement in the cell in response to nervous electrical impulses. When this happens, new arrangements of these proteins give the muscle cells a shorter form. Remember when we talked about muscle tissue in Class IX, there were different kinds of muscles, such as voluntary muscles and involuntary muscles. Based on what we have discussed so far, what do you think the differences between these would be?

Q U E S T I O N S

1. What is the difference between a reflex action and walking?
2. What happens at the synapse between two neurons?
3. Which part of the brain maintains posture and equilibrium of the body?
4. How do we detect the smell of an *agarbatti* (incense stick)?
5. What is the role of the brain in reflex action?



7.2 COORDINATION IN PLANTS

Animals have a nervous system for controlling and coordinating the activities of the body. But plants have neither a nervous system nor muscles. So, how do they respond to stimuli? When we touch the leaves of a *chhui-mui* (the 'sensitive' or 'touch-me-not' plant of the Mimosa family), they begin to fold up and droop. When a seed germinates, the root goes down, the stem comes up into the air. What happens? Firstly, the leaves of the sensitive plant move very quickly in response to touch.

There is no growth involved in this movement. On the other hand, the directional movement of a seedling is caused by growth. If it is prevented from growing, it will not show any movement. So plants show two different types of movement – one dependent on growth and the other independent of growth.

7.2.1 Immediate Response to Stimulus

Let us think about the first kind of movement, such as that of the sensitive plant. Since no growth is involved, the plant must actually move its leaves in response to touch. But there is no nervous tissue, nor any muscle tissue. How does the plant detect the touch, and how do the leaves move in response?

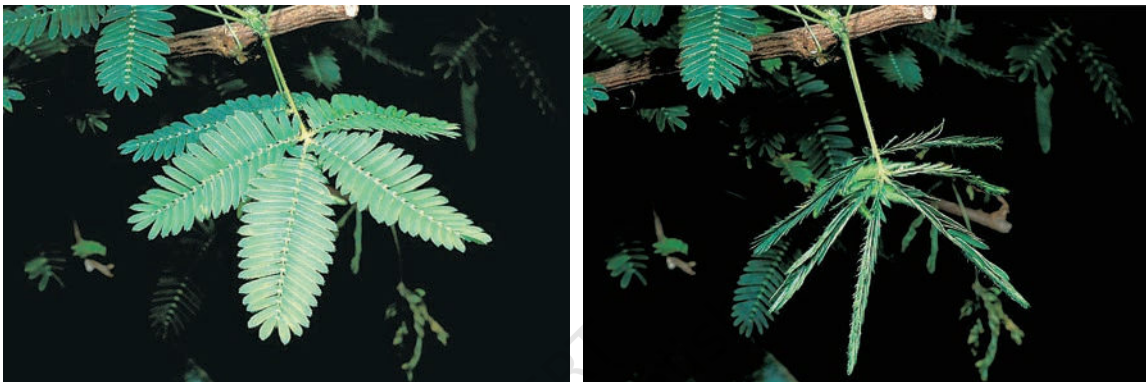

Figure 7.4 The sensitive plant

If we think about where exactly the plant is touched, and what part of the plant actually moves, it is apparent that movement happens at a point different from the point of touch. So, information that a touch has occurred must be communicated. The plants also use electrical-chemical means to convey this information from cell to cell, but unlike in animals, there is no specialised tissue in plants for the conduction of information. Finally, again as in animals, some cells must change shape in order for movement to happen. Instead of the specialised proteins found in animal muscle cells, plant cells change shape by changing the amount of water in them, resulting in swelling or shrinking, and therefore in changing shapes.

7.2.2 Movement Due to Growth

Some plants like the pea plant climb up other plants or fences by means of tendrils. These tendrils are sensitive to touch. When they come in contact with any support, the part of the tendril in contact with the object does not grow as rapidly as the part of the tendril away from the object. This causes the tendril to circle around the object and thus cling to it. More commonly, plants respond to stimuli slowly by growing in a particular direction. Because this growth is directional, it appears as if the plant is moving. Let us understand this type of movement with the help of an example.

Activity 7.2

- Fill a conical flask with water.
- Cover the neck of the flask with a wire mesh.
- Keep two or three freshly germinated bean seeds on the wire mesh.
- Take a cardboard box which is open from one side.
- Keep the flask in the box in such a manner that the open side of the box faces light coming from a window (Fig. 7.5).
- After two or three days, you will notice that the shoots bend towards light and roots away from light.
- Now turn the flask so that the shoots are away from light and the roots towards light. Leave it undisturbed in this condition for a few days.
- Have the old parts of the shoot and root changed direction?
- Are there differences in the direction of the new growth?
- What can we conclude from this activity?

Environmental triggers such as light, or gravity will change the directions that plant parts grow in. These directional, or tropic, movements can be either towards the stimulus, or away from it. So, in two different kinds of phototropic movement, shoots respond by bending towards light while roots respond by bending away from it. How does this help the plant?

Plants show tropism in response to other stimuli as well. The roots of a plant always grow downwards while the shoots usually grow upwards and away from the earth. This upward and downward growth of shoots and roots, respectively, in response to the pull of earth or gravity is, obviously, geotropism (Fig. 7.6). If 'hydro' means water and 'chemo' refers to chemicals, what would 'hydrotropism' and 'chemotropism' mean? Can we think of examples of these kinds of directional growth movements? One example of chemotropism is the growth of pollen tubes towards ovules, about which we will learn more when we examine the reproductive processes of living organisms.

Let us now once again think about how information is communicated in the bodies of multicellular organisms. The movement of the sensitive plant in response to touch is very quick. The movement of sunflowers in response to day or night, on the other hand, is quite slow. Growth-related movement of plants will be even slower.

Even in animal bodies, there are carefully controlled directions to growth. Our arms and fingers grow in certain directions, not haphazardly. So controlled movements can be either slow or fast. If fast responses to stimuli are to be made, information transfer must happen very quickly. For this, the medium of transmission must be able to move rapidly.

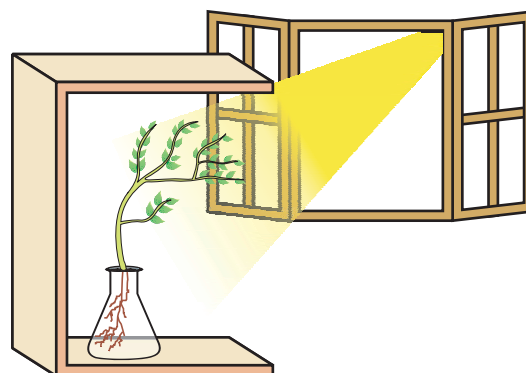

Figure 7.5
Response of the plant to the direction of light

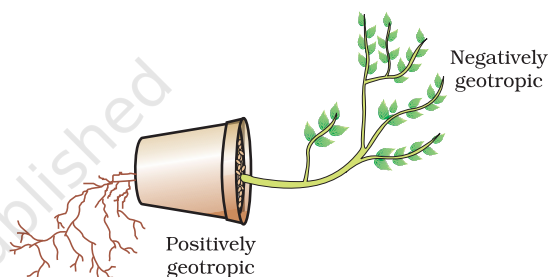

Figure 7.6 Plant showing geotropism

Electrical impulses are an excellent means for this. But there are limitations to the use of electrical impulses. Firstly, they will reach only those cells that are connected by nervous tissue, not each and every cell in the animal body. Secondly, once an electrical impulse is generated in a cell and transmitted, the cell will take some time to reset its mechanisms before it can generate and transmit a new impulse. In other words, cells cannot continually create and transmit electrical impulses. It is thus no wonder that most multicellular organisms use another means of communication between cells, namely, chemical communication.

If, instead of generating an electrical impulse, stimulated cells release a chemical compound, this compound would diffuse all around the original cell. If other cells around have the means to detect this compound using special molecules on their surfaces, then they would be able to recognise information, and even transmit it. This will be slower, of course, but it can potentially reach all cells of the body, regardless of nervous connections, and it can be done steadily and persistently. These compounds, or hormones used by multicellular organisms for control and coordination show a great deal of diversity, as we would expect. Different plant hormones help to coordinate growth, development and responses to the environment. They are synthesised at places away from where they act and simply diffuse to the area of action.

Let us take an example that we have worked with earlier [Activity 7.2]. When growing plants detect light, a hormone called auxin, synthesised at the shoot tip, helps the cells to grow longer. When light is coming from one side of the plant, auxin diffuses towards the shady side of the shoot. This concentration of auxin stimulates the cells to grow longer on the side of the shoot which is away from light. Thus, the plant appears to bend towards light.

Another example of plant hormones are gibberellins which, like auxins, help in the growth of the stem. Cytokinins promote cell division, and it is natural then that they are present in greater concentration in areas of rapid cell division, such as in fruits and seeds. These are examples of plant hormones that help in promoting growth. But plants also need signals to stop growing. Abscisic acid is one example of a hormone which inhibits growth. Its effects include wilting of leaves.

Q U E S T I O N S

1. What are plant hormones?
2. How is the movement of leaves of the sensitive plant different from the movement of a shoot towards light?
3. Give an example of a plant hormone that promotes growth.
4. How do auxins promote the growth of a tendril around a support?
5. Design an experiment to demonstrate hydrotropism.



7.3 HORMONES IN ANIMALS

How are such chemical, or hormonal, means of information transmission used in animals? What do some animals, for instance squirrels, experience when they are in a scary situation? Their bodies have to prepare for either fighting or running away. Both are very complicated activities that will use a great deal of energy in controlled ways. Many different tissue types will be used and their activities integrated together in these actions. However, the two alternate activities, fighting or running, are also quite different! So here is a situation in which some common preparations can be usefully made in the body. These preparations should ideally make it easier to do either activity in the near future. How would this be achieved?

If the body design in the squirrel relied only on electrical impulses via nerve cells, the range of tissues instructed to prepare for the coming activity would be limited. On the other hand, if a chemical signal were to be sent as well, it would reach all cells of the body and provide the wide-ranging changes needed. This is done in many animals, including human beings, using a hormone called adrenaline that is secreted from the adrenal glands. Look at Fig. 7.7 to locate these glands.

Adrenaline is secreted directly into the blood and carried to different parts of the body. The target organs or the specific tissues on which it acts include the heart. As a result, the heart beats faster, resulting in supply of more oxygen to our muscles. The blood to the digestive system and skin is reduced due to contraction of muscles around small arteries in these organs. This diverts the blood to our skeletal muscles. The breathing rate also increases because of the contractions of the diaphragm and the rib muscles. All these responses together enable the animal body to be ready to deal with the situation. Such animal hormones are part of the endocrine system which constitutes a second way of control and coordination in our body.

Activity 7.3

- Look at Fig. 7.7.
- Identify the endocrine glands mentioned in the figure.
- Some of these glands have been listed in Table 7.1 and discussed in the text. Consult books in the library and discuss with your teachers to find out about other glands.

Remember that plants have hormones that control their directional growth. What functions do animal hormones perform? On the face of it, we cannot imagine their role in directional growth. We have never seen an animal growing more in one direction or the other, depending on light or gravity! But if we think about it a bit more, it will become evident that, even in animal bodies, growth happens in carefully controlled places. Plants will grow leaves in many places on the plant body, for example. But we do not grow fingers on our faces. The design of the body is carefully maintained even during the growth of children.

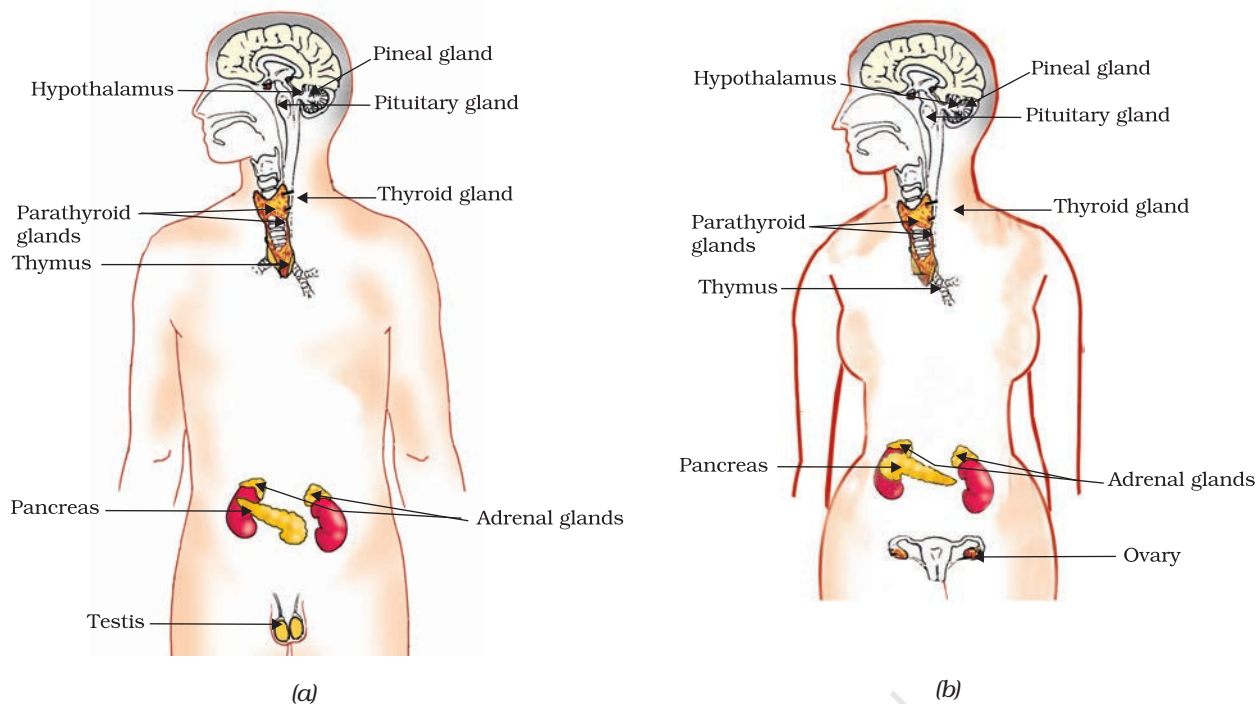

Figure 7.7 Endocrine glands in human beings (a) male, (b) female

Do You Know?

Hypothalamus plays an important role in the release of many hormones. For example, when the level of growth hormone is low, the hypothalamus releases growth hormone releasing factor which stimulates the pituitary gland to release growth hormone.

Let us examine some examples to understand how hormones help in coordinated growth. We have all seen salt packets which say 'iodised salt' or 'enriched with iodine'. Why is it important for us to have iodised salt in our diet? Iodine is necessary for the thyroid gland to make thyroxin hormone. Thyroxin regulates carbohydrate, protein and fat metabolism in the body so as to provide the best balance for growth. Iodine is essential for the synthesis of thyroxin. In case iodine is deficient in our diet, there is a possibility that we might suffer from goitre. One of the symptoms in this disease is a swollen neck. Can you correlate this with the position of the thyroid gland in Fig. 7.7?

Sometimes we come across people who are either very short (dwarfs) or extremely tall (giants). Have you ever wondered how this happens? Growth hormone is one of the hormones secreted by the pituitary. As its name indicates, growth hormone regulates growth and development of the body. If there is a deficiency of this hormone in childhood, it leads to dwarfism.

You must have noticed many dramatic changes in your appearance as well as that of your friends as you approached 10–12 years of age. These changes associated with puberty are because of the secretion of testosterone in males and oestrogen in females.

Do you know anyone in your family or friends who has been advised by the doctor to take less sugar in their diet because they are suffering from diabetes? As a treatment, they might be taking injections of insulin. This is a hormone which is produced by the pancreas and helps in regulating blood sugar levels. If it is not secreted in proper amounts, the sugar level in the blood rises causing many harmful effects.

If it is so important that hormones should be secreted in precise quantities, we need a mechanism through which this is done. The timing and amount of hormone released are regulated by feedback mechanisms. For example, if the sugar levels in blood rise, they are detected by the cells of the pancreas which respond by producing more insulin. As the blood sugar level falls, insulin secretion is reduced.

Activity 7.4

- Hormones are secreted by endocrine glands and have specific functions. Complete Table 7.1 based on the hormone, the endocrine gland or the functions provided.

Table 7.1 : Some important hormones and their functions

S.No.	Hormone	Endocrine Gland	Functions
1.	Growth hormone	Pituitary gland	Stimulates growth in all organs
2.		Thyroid gland	Regulates metabolism for body growth
3.	Insulin		Regulates blood sugar level
4.	Testosterone	Testes	
5.		Ovaries	Development of female sex organs, regulates menstrual cycle, etc.
6.	Adrenaline	Adrenal gland	
7.	Releasing hormones		Stimulates pituitary gland to release hormones

Q U E S T I O N S

- How does chemical coordination take place in animals?
- Why is the use of iodised salt advisable?
- How does our body respond when adrenaline is secreted into the blood?
- Why are some patients of diabetes treated by giving injections of insulin?



What you have learnt

- Control and coordination are the functions of the nervous system and hormones in our bodies.
- The responses of the nervous system can be classified as reflex action, voluntary action or involuntary action.
- The nervous system uses electrical impulses to transmit messages.
- The nervous system gets information from our sense organs and acts through our muscles.
- Chemical coordination is seen in both plants and animals.
- Hormones produced in one part of an organism move to another part to achieve the desired effect.
- A feedback mechanism regulates the action of the hormones.

E X E R C I S E S

1. Which of the following is a plant hormone?
 - (a) Insulin
 - (b) Thyroxin
 - (c) Oestrogen
 - (d) Cytokinin.
2. The gap between two neurons is called a
 - (a) dendrite.
 - (b) synapse.
 - (c) axon.
 - (d) impulse.
3. The brain is responsible for
 - (a) thinking.
 - (b) regulating the heart beat.
 - (c) balancing the body.
 - (d) all of the above.
4. What is the function of receptors in our body? Think of situations where receptors do not work properly. What problems are likely to arise?
5. Draw the structure of a neuron and explain its function.
6. How does phototropism occur in plants?
7. Which signals will get disrupted in case of a spinal cord injury?
8. How does chemical coordination occur in plants?
9. What is the need for a system of control and coordination in an organism?
10. How are involuntary actions and reflex actions different from each other?
11. Compare and contrast nervous and hormonal mechanisms for control and coordination in animals.
12. What is the difference between the manner in which movement takes place in a sensitive plant and the movement in our legs?



CHAPTER 8

How do Organisms Reproduce?



1064CH08

Before we discuss the mechanisms by which organisms reproduce, let us ask a more basic question – why do organisms reproduce? After all, reproduction is not necessary to maintain the life of an individual organism, unlike the essential life processes such as nutrition, respiration, or excretion. On the other hand, if an individual organism is going to create more individuals, a lot of its energy will be spent in the process. So why should an individual organism waste energy on a process it does not need to stay alive? It would be interesting to discuss the possible answers in the classroom!

Whatever the answer to this question, it is obvious that we notice organisms because they reproduce. If there were to be only one, non-reproducing member of a particular kind, it is doubtful that we would have noticed its existence. It is the large numbers of organisms belonging to a single species that bring them to our notice. How do we know that two different individual organisms belong to the same species? Usually, we say this because they look similar to each other. Thus, reproducing organisms create new individuals that look very much like themselves.

8.1 DO ORGANISMS CREATE EXACT COPIES OF THEMSELVES?

Organisms look similar because their body designs are similar. If body designs are to be similar, the blueprints for these designs should be similar. Thus, reproduction at its most basic level will involve making copies of the blueprints of body design. In Class IX, we learnt that the chromosomes in the nucleus of a cell contain information for inheritance of features from parents to next generation in the form of DNA (Deoxyribo Nucleic Acid) molecules. The DNA in the cell nucleus is the information source for making proteins. If the information is changed, different proteins will be made. Different proteins will eventually lead to altered body designs.

Therefore, a basic event in reproduction is the creation of a DNA copy. Cells use chemical reactions to build copies of their DNA. This creates two copies of the DNA in a reproducing cell, and they will need to be separated from each other. However, keeping one copy of DNA in the original cell and simply pushing the other one out would not work,

because the copy pushed out would not have any organised cellular structure for maintaining life processes. Therefore, DNA copying is accompanied by the creation of an additional cellular apparatus, and then the DNA copies separate, each with its own cellular apparatus. Effectively, a cell divides to give rise to two cells.

These two cells are of course similar, but are they likely to be absolutely identical? The answer to this question will depend on how accurately the copying reactions involved occur. No bio-chemical reaction is absolutely reliable. Therefore, it is only to be expected that the process of copying the DNA will have some variations each time. As a result, the DNA copies generated will be similar, but may not be identical to the original. Some of these variations might be so drastic that the new DNA copy cannot work with the cellular apparatus it inherits. Such a newborn cell will simply die. On the other hand, there could still be many other variations in the DNA copies that would not lead to such a drastic outcome. Thus, the surviving cells are similar to, but subtly different from each other. This inbuilt tendency for variation during reproduction is the basis for evolution, as we will discuss in the next chapter.

8.1.1 The Importance of Variation

Populations of organisms fill well-defined places, or niches, in the ecosystem, using their ability to reproduce. The consistency of DNA copying during reproduction is important for the maintenance of body design features that allow the organism to use that particular niche. Reproduction is therefore linked to the stability of populations of species.

However, niches can change because of reasons beyond the control of the organisms. Temperatures on earth can go up or down, water levels can vary, or there could be meteorite hits, to think of a few examples. If a population of reproducing organisms were suited to a particular niche and if the niche were drastically altered, the population could be wiped out. However, if some variations were to be present in a few individuals in these populations, there would be some chance for them to survive. Thus, if there were a population of bacteria living in temperate waters, and if the water temperature were to be increased by global warming, most of these bacteria would die, but the few variants resistant to heat would survive and grow further. Variation is thus useful for the survival of species over time.

Q U E S T I O N S

1. What is the importance of DNA copying in reproduction?
2. Why is variation beneficial to the species but not necessarily for the individual?



8.2 MODES OF REPRODUCTION USED BY SINGLE ORGANISMS

Activity 8.1

- Dissolve about 10 gm of sugar in 100 mL of water.
- Take 20 mL of this solution in a test tube and add a pinch of yeast granules to it.
- Put a cotton plug on the mouth of the test tube and keep it in a warm place.
- After 1 or 2 hours, put a small drop of yeast culture from the test tube on a slide and cover it with a coverslip.
- Observe the slide under a microscope.

Activity 8.2

- Wet a slice of bread, and keep it in a cool, moist and dark place.
- Observe the surface of the slice with a magnifying glass.
- Record your observations for a week.

Compare and contrast the ways in which yeast grows in the first case, and how mould grows in the second.

Having discussed the context in which reproductive processes work, let us now examine how different organisms actually reproduce. The modes by which various organisms reproduce depend on the body design of the organisms.

8.2.1 Fission

For unicellular organisms, cell division, or fission, leads to the creation of new individuals. Many different patterns of fission have been observed. Many bacteria and protozoa simply split into two equal halves during cell division. In organisms such as *Amoeba*, the splitting of the two cells during division can take place in any plane.

Activity 8.3

- Observe a permanent slide of *Amoeba* under a microscope.
- Similarly observe another permanent slide of *Amoeba* showing binary fission.
- Now, compare the observations of both the slides.

However, some unicellular organisms show somewhat more organisation of their bodies, such as is seen in *Leishmania* (which cause *kala-azar*), which have a whip-like structure at one end of the cell. In such organisms, binary fission occurs in a definite orientation in relation to

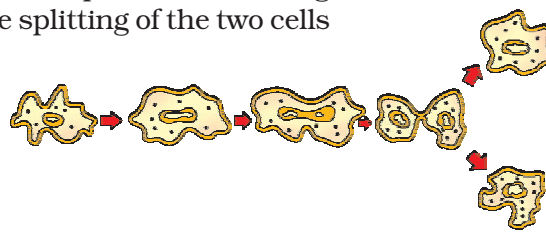

Figure 8.1(a) Binary fission in *Amoeba*

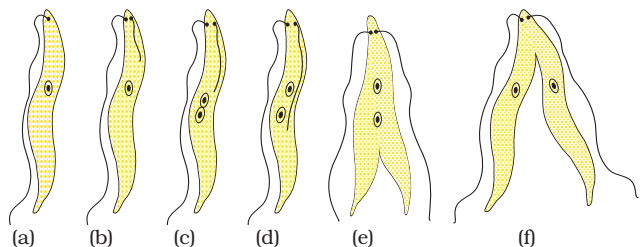

Figure 8.1(b) Binary fission in *Leishmania*

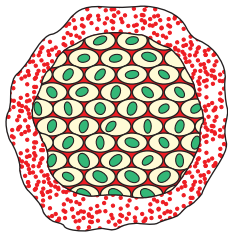

Figure 8.2
Multiple fission in *Plasmodium*

these structures. Other single-celled organisms, such as the malarial parasite, *Plasmodium*, divide into many daughter cells simultaneously by multiple fission.

Yeast, on the other hand, can put out small buds that separate and grow further, as we saw in Activity 8.1.

8.2.2 Fragmentation

Activity 8.4

- Collect water from a lake or pond that appears dark green and contains filamentous structures.
- Put one or two filaments on a slide.
- Put a drop of glycerine on these filaments and cover it with a coverslip.
- Observe the slide under a microscope.
- Can you identify different tissues in the *Spirogyra* filaments?

In multi-cellular organisms with relatively simple body organisation, simple reproductive methods can still work. *Spirogyra*, for example, simply breaks up into smaller pieces upon maturation. These pieces or fragments grow into new individuals. Can we work out the reason for this, based on what we saw in Activity 8.4?

This is not true for all multi-cellular organisms. They cannot simply divide cell-by-cell. The reason is that many multi-cellular organisms, as we have seen, are not simply a random collection of cells. Specialised cells are organised as tissues, and tissues are organised into organs, which then have to be placed at definite positions in the body. In such a carefully organised situation, cell-by-cell division would be impractical. Multi-cellular organisms, therefore, need to use more complex ways of reproduction.

A basic strategy used in multi-cellular organisms is that different cell types perform different specialised functions. Following this general pattern, reproduction in such organisms is also the function of a specific cell type. How is reproduction to be achieved from a single cell type, if the organism itself consists of many cell types? The answer is that there must be a single cell type in the organism that is capable of growing, proliferating and making other cell types under the right circumstances.

8.2.3 Regeneration

Many fully differentiated organisms have the ability to give rise to new individual organisms from their body parts. That is, if the individual is somehow cut or broken up into many pieces, many of these pieces grow into separate individuals. For example, simple animals like *Hydra* and *Planaria* can be cut into any number of pieces and each piece grows into a complete organism. This is known as regeneration (see Fig. 8.3). Regeneration is carried out by specialised cells. These cells proliferate and make large numbers of cells. From this mass of cells, different cells undergo changes to become various cell types and tissues. These changes

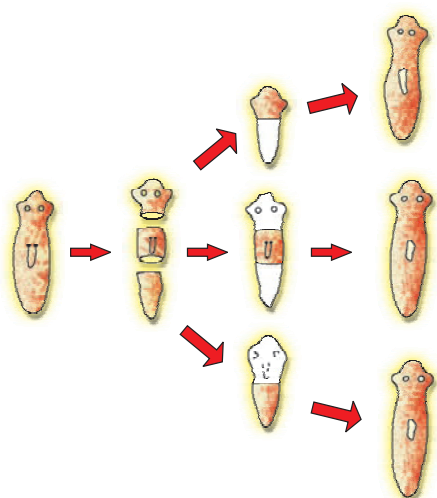

Figure 8.3 Regeneration in *Planaria*

specific site (Fig. 8.4). These buds develop into tiny individuals and when fully mature, detach from the parent body and become new independent individuals.

take place in an organised sequence referred to as development. However, regeneration is not the same as reproduction, since most organisms would not normally depend on being cut up to be able to reproduce.

8.2.4 Budding

Organisms such as *Hydra* use regenerative cells for reproduction in the process of budding. In *Hydra*, a bud develops as an outgrowth due to repeated cell division at one

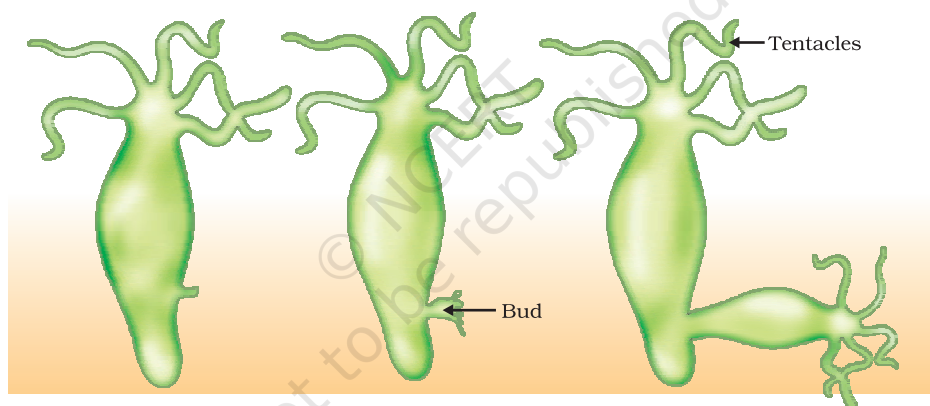

Figure 8.4 Budding in *Hydra*

8.2.5 Vegetative Propagation

There are many plants in which parts like the root, stem and leaves develop into new plants under appropriate conditions. Unlike in most animals, plants can indeed use such a mode for reproduction. This property of vegetative propagation is used in methods such as layering or grafting to grow many plants like sugarcane, roses, or grapes for agricultural purposes. Plants raised by vegetative propagation can bear flowers and fruits earlier than those produced from seeds. Such methods also make possible the propagation of plants such as banana, orange, rose and jasmine that have lost the capacity to produce seeds. Another advantage of vegetative propagation is that all plants produced are genetically similar enough to the parent plant to have all its characteristics.

Activity 8.5

- Take a potato and observe its surface. Can notches be seen?
- Cut the potato into small pieces such that some pieces contain a notch or bud and some do not.
- Spread some cotton on a tray and wet it. Place the potato pieces on this cotton. Note where the pieces with the buds are placed.
- Observe changes taking place in these potato pieces over the next few days. Make sure that the cotton is kept moistened.
- Which are the potato pieces that give rise to fresh green shoots and roots?

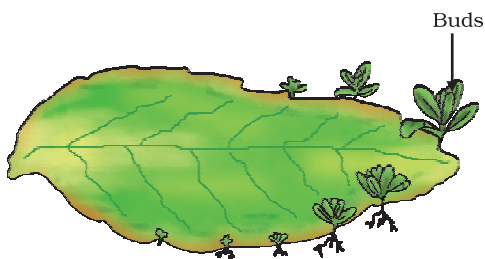

Figure 8.5
Leaf of *Bryophyllum*
with buds

Similarly buds produced in the notches along the leaf margin of *Bryophyllum* fall on the soil and develop into new plants (Fig. 8.5).

Activity 8.6

- Select a money-plant.
- Cut some pieces such that they contain at least one leaf.
- Cut out some other portions between two leaves.
- Dip one end of all the pieces in water and observe over the next few days.
- Which ones grow and give rise to fresh leaves?
- What can you conclude from your observations?

More to Know?

Tissue culture

In tissue culture, new plants are grown by removing tissue or separating cells from the growing tip of a plant. The cells are then placed in an artificial medium where they divide rapidly to form a small group of cells or callus. The callus is transferred to another medium containing hormones for growth and differentiation. The plantlets are then placed in the soil so that they can grow into mature plants. Using tissue culture, many plants can be grown from one parent in disease-free conditions. This technique is commonly used for ornamental plants.

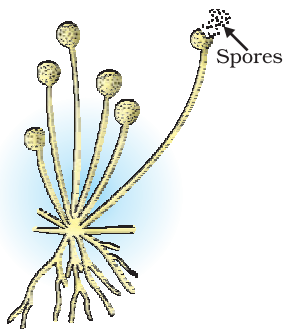

Figure 8.6
Spore formation in *Rhizopus*

8.2.6 Spore Formation

Even in many simple multi-cellular organisms, specific reproductive parts can be identified. The thread-like structures that developed on the bread in Activity 8.2 above are the hyphae of the bread mould (*Rhizopus*). They are not reproductive parts. On the other hand, the tiny blob-on-a-stick structures are involved in reproduction. The blobs are sporangia, which contain cells, or spores, that can eventually develop into new *Rhizopus* individuals (Fig. 8.6). The spores are covered by thick walls that protect them until they come into contact with another moist surface and can begin to grow.

All the modes of reproduction that we have discussed so far allow new generations to be created from a single individual. This is known as asexual reproduction.

Q U E S T I O N S

1. How does binary fission differ from multiple fission?
2. How will an organism be benefited if it reproduces through spores?
3. Can you think of reasons why more complex organisms cannot give rise to new individuals through regeneration?
4. Why is vegetative propagation practised for growing some types of plants?
5. Why is DNA copying an essential part of the process of reproduction?



8.3 SEXUAL REPRODUCTION

We are also familiar with modes of reproduction that depend on the involvement of two individuals before a new generation can be created. Bulls alone cannot produce new calves, nor can hens alone produce new chicks. In such cases, both sexes, males and females, are needed to produce new generations. What is the significance of this sexual mode of reproduction? Are there any limitations of the asexual mode of reproduction, which we have been discussing above?

8.3.1 Why the Sexual Mode of Reproduction?

The creation of two new cells from one involves copying of the DNA as well as of the cellular apparatus. The DNA copying mechanism, as we have noted, cannot be absolutely accurate, and the resultant errors are a source of variations in populations of organisms. Every individual organism cannot be protected by variations, but in a population, variations are useful for ensuring the survival of the species. It would therefore make sense if organisms came up with reproductive modes that allowed more and more variation to be generated.

While DNA-copying mechanisms are not absolutely accurate, they are precise enough to make the generation of variation a fairly slow process. If the DNA copying mechanisms were to be less accurate, many of the resultant DNA copies would not be able to work with the cellular apparatus, and would die. So how can the process of making variants be speeded up? Each new variation is made in a DNA copy that already has variations accumulated from previous generations. Thus, two different individuals in a population would have quite different patterns of accumulated variations. Since all of these variations are in living individuals, it is assured that they do not have any really bad effects. Combining variations from two or more individuals would thus create new combinations of variants. Each combination would be novel, since it would involve two different individuals. The sexual mode of

reproduction incorporates such a process of combining DNA from two different individuals during reproduction.

But this creates a major difficulty. If each new generation is to be the combination of the DNA copies from two pre-existing individuals, then each new generation will end up having twice the amount of DNA that the previous generation had. This is likely to mess up the control of the cellular apparatus by the DNA. How many ways can we think of for solving this difficulty?

We have seen earlier that as organisms become more complex, the specialisation of tissue increases. One solution that many multi-cellular organisms have found for the problem mentioned above is to have special lineages of cells in specialised organs in which only half the number of chromosomes and half the amount of DNA as compared to the non-reproductive body cells. This is achieved by a process of cell division called meiosis. Thus, when these germ-cells from two individuals combine during sexual reproduction to form a new individual, it results in re-establishment of the number of chromosomes and the DNA content in the new generation.

If the zygote is to grow and develop into an organism which has highly specialised tissues and organs, then it has to have sufficient stores of energy for doing this. In very simple organisms, it is seen that the two germ-cells are not very different from one another, or may even be similar. But as the body designs become more complex, the germ-cells also specialise. One germ-cell is large and contains the food-stores while the other is smaller and likely to be motile. Conventionally, the motile germ-cell is called the male gamete and the germ-cell containing the stored food is called the female gamete. We shall see in the next few sections how the need to create these two different types of gametes give rise to differences in the male and female reproductive organs and, in some cases, differences in the bodies of the male and female organisms.

8.3.2 Sexual Reproduction in Flowering Plants

The reproductive parts of angiosperms are located in the flower. You have already studied the different parts of a flower – sepals, petals,

stamens and pistil. Stamens and pistil are the reproductive parts of a flower which contain the germ-cells. What possible functions could the petals and sepals serve?

The flower may be unisexual (papaya, watermelon) when it contains either stamens or pistil or bisexual (*Hibiscus*, mustard) when it contains both stamens and pistil. Stamen is the male reproductive part and it produces pollen grains that are yellowish in colour. You must have seen this yellowish powder that often sticks to our hands if we touch the stamen of a flower. Pistil is present in the centre of a flower and is the female reproductive part. It is made of three parts.

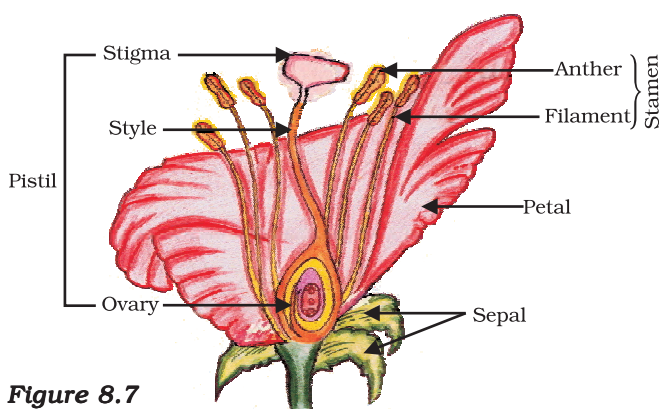

Figure 8.7
Longitudinal section of flower

The swollen bottom part is the ovary, middle elongated part is the style and the terminal part which may be sticky is the stigma. The ovary contains ovules and each ovule has an egg cell. The male germ-cell produced by pollen grain fuses with the female gamete present in the ovule. This fusion of the germ-cells or fertilisation gives us the zygote which is capable of growing into a new plant.

Thus the pollen needs to be transferred from the stamen to the stigma. If this transfer of pollen occurs in the same flower, it is referred to as self-pollination. On the other hand, if the pollen is transferred from one flower to another, it is known as cross-pollination. This transfer of pollen from one flower to another is achieved by agents like wind, water or animals.

After the pollen lands on a suitable stigma, it has to reach the female germ-cells which are in the ovary. For this, a tube grows out of the pollen grain and travels through the style to reach the ovary.

After fertilisation, the zygote divides several times to form an embryo within the ovule. The ovule develops a tough coat and is gradually converted into a seed. The ovary grows rapidly and ripens to form a fruit. Meanwhile, the petals, sepals, stamens, style and stigma may shrivel and fall off. Have you ever observed any flower part still persisting in the fruit? Try and work out the advantages of seed-formation for the plant. The seed contains the future plant or embryo which develops into a seedling under appropriate conditions. This process is known as germination.

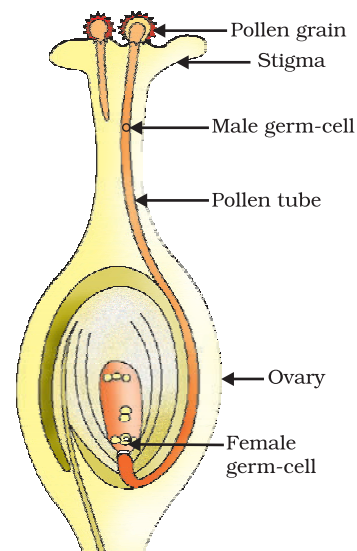

Figure 8.8
Germination of pollen on stigma

Activity 8.7

- Soak a few seeds of Bengal gram (*chana*) and keep them overnight.
- Drain the excess water and cover the seeds with a wet cloth and leave them for a day. Make sure that the seeds do not become dry.
- Cut open the seeds carefully and observe the different parts.
- Compare your observations with the Fig. 8.9 and see if you can identify all the parts.

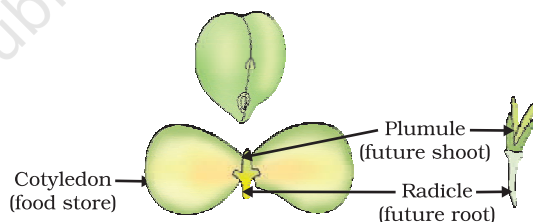

Figure 8.9
Germination

8.3.3 Reproduction in Human Beings

So far, we have been discussing the variety of modes that different species use for reproduction. Let us now look at the species that we are most interested in, namely, humans. Humans use a sexual mode of reproduction. How does this process work?

Let us begin at an apparently unrelated point. All of us know that our bodies change as we become older. You have learnt changes that take place in your body earlier in Class VIII also. We notice that our height has increased continuously from early age till now. We acquire teeth, we even lose the old, so-called milk teeth and acquire new ones.

All of these are changes that can be grouped under the general process of growth, in which the body becomes larger. But in early teenage years, a whole new set of changes occurs that cannot be explained simply as body enlargement. Instead, the appearance of the body changes. Proportions change, new features appear, and so do new sensations.

Some of these changes are common to both boys and girls. We begin to notice thick hair growing in new parts of the body such as armpits and the genital area between the thighs, which can also become darker in colour. Thinner hair can also appear on legs and arms, as well as on the face. The skin frequently becomes oily and we might begin to develop pimples. We begin to be conscious and aware of both our own bodies and those of others in new ways.

On the other hand, there are also changes taking place that are different between boys and girls. In girls, breast size begins to increase, with darkening of the skin of the nipples at the tips of the breasts. Also, girls begin to menstruate at around this time. Boys begin to have new thick hair growth on the face and their voices begin to crack. Further, the penis occasionally begins to become enlarged and erect, either in daydreams or at night.

All of these changes take place slowly, over a period of months and years. They do not happen all at the same time in one person, nor do they happen at an exact age. In some people, they happen early and quickly, while in others, they can happen slowly. Also, each change does not become complete quickly either. So, for example, thick hair on the face in boys appears as a few scattered hairs first, and only slowly does the growth begin to become uniform. Even so, all these changes show differences between people. Just as we have differently shaped noses or fingers, so also we have different patterns of hair growth, or size and shape of breast or penis. All of these changes are aspects of the sexual maturation of the body.

Why does the body show sexual maturation at this age? We have talked about the need for specialised cell types in multi-cellular bodies to carry out specialised functions. The creation of germ-cells to participate in sexual reproduction is another specialised function, and we have seen that plants develop special cell and tissue types to create them. Human beings also develop special tissues for this purpose. However, while the body of the individual organism is growing to its adult size, the resources of the body are mainly directed at achieving this growth. While that is happening, the maturation of the reproductive tissue is not likely to be a major priority. Thus, as the rate of general body growth begins to slow down, reproductive tissues begin to mature. This period during adolescence is called puberty.

So how do all the changes that we have talked about link to the reproductive process? We must remember that the sexual mode of reproduction means that germ-cells from two individuals have to join together. This can happen by the external release of germ-cells from the bodies of individuals, as happens in flowering plants. Or it can happen by two individuals joining their bodies together for internal transfer of germ-cells for fusion, as happens in many animals. If animals are to

participate in this process of mating, their state of sexual maturity must be identifiable by other individuals. Many changes during puberty, such as new hair-growth patterns, are signals that sexual maturation is taking place.

On the other hand, the actual transfer of germ-cells between two people needs special organs for the sexual act, such as the penis when it is capable of becoming erect. In mammals such as humans, the baby is carried in the mother's body for a long period, and will be breast-fed later. The female reproductive organs and breasts will need to mature to accommodate these possibilities. Let us look at the systems involved in the process of sexual reproduction.

8.3.3 (a) Male Reproductive System

The male reproductive system (Fig. 8.10) consists of portions which produce the germ-cells and other portions that deliver the germ-cells to the site of fertilisation.

The formation of germ-cells or sperms takes place in the testes. These are located outside the abdominal cavity in scrotum because sperm formation requires a lower temperature than the normal body temperature. We have discussed the role of the testes in the secretion of the hormone, testosterone, in the previous chapter. In addition to regulating the formation of sperms, testosterone brings about changes in appearance seen in boys at the time of puberty.

The sperms formed are delivered through the vas deferens which unites with a tube coming from the urinary bladder. The urethra thus forms a common passage for both the sperms and urine. Along the path of the vas deferens, glands like the prostate and the seminal vesicles add their secretions so that the sperms are now in a fluid which makes their transport easier and this fluid also provides nutrition. The sperms are tiny bodies that consist of mainly genetic material and a long tail that helps them to move towards the female germ-cell.

8.3.3 (b) Female Reproductive System

The female germ-cells or eggs are made in the ovaries. They are also responsible for the production of some hormones. Look at Fig. 8.11 and identify the various organs in the female reproductive system.

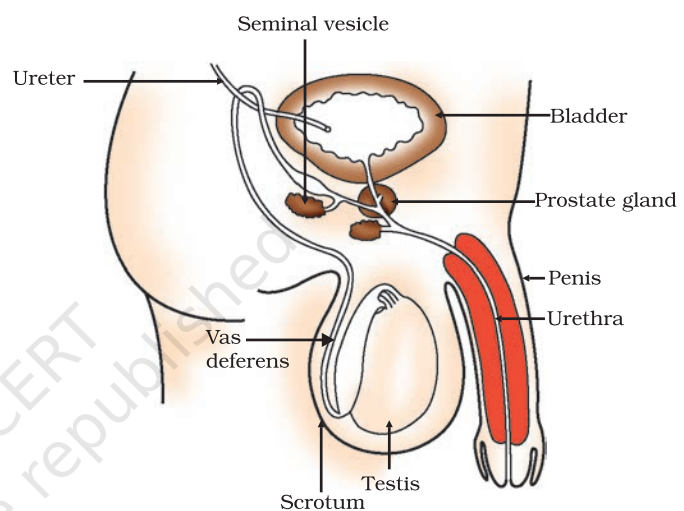

Figure 8.10 Human–male reproductive system

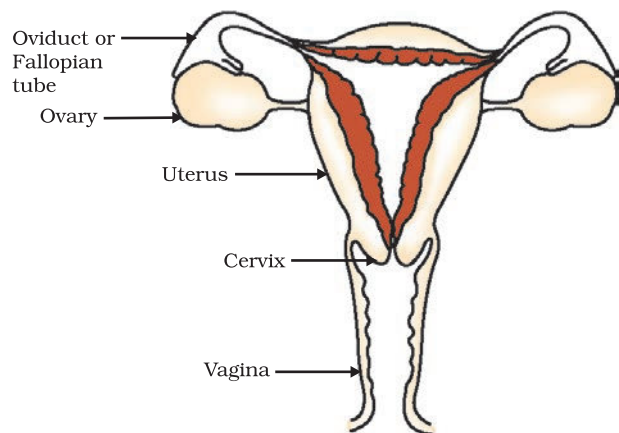

Figure 8.11 Human–female reproductive system

When a girl is born, the ovaries already contain thousands of immature eggs. On reaching puberty, some of these start maturing. One egg is produced every month by one of the ovaries. The egg is carried from the ovary to the womb through a thin oviduct or fallopian tube. The two oviducts unite into an elastic bag-like structure known as the uterus. The uterus opens into the vagina through the cervix.

The sperms enter through the vaginal passage during sexual intercourse. They travel upwards and reach the oviduct where they may encounter the egg. The fertilised egg (zygote) starts dividing and form a ball of cells or embryo. The embryo is implanted in the lining of the uterus where they continue to grow and develop organs to become foetus. We have seen in earlier sections that the mother's body is designed to undertake the development of the child. Hence the uterus prepares itself every month to receive and nurture the growing embryo. The lining thickens and is richly supplied with blood to nourish the growing embryo.

The embryo gets nutrition from the mother's blood with the help of a special tissue called placenta. This is a disc which is embedded in the uterine wall. It contains villi on the embryo's side of the tissue. On the mother's side are blood spaces, which surround the villi. This provides a large surface area for glucose and oxygen to pass from the mother to the embryo. The developing embryo will also generate waste substances which can be removed by transferring them into the mother's blood through the placenta. The development of the child inside the mother's body takes approximately nine months. The child is born as a result of rhythmic contractions of the muscles in the uterus.

8.3.3 (c) What happens when the Egg is not Fertilised?

If the egg is not fertilised, it lives for about one day. Since the ovary releases one egg every month, the uterus also prepares itself every month to receive a fertilised egg. Thus its lining becomes thick and spongy. This would be required for nourishing the embryo if fertilisation had taken place. Now, however, this lining is not needed any longer. So, the lining slowly breaks and comes out through the vagina as blood and mucous. This cycle takes place roughly every month and is known as menstruation. It usually lasts for about two to eight days.

8.3.3 (d) Reproductive Health

As we have seen, the process of sexual maturation is gradual, and takes place while general body growth is still going on. Therefore, some degree of sexual maturation does not necessarily mean that the body or the mind is ready for sexual acts or for having and bringing up children. How do we decide if the body or the mind is ready for this major responsibility? All of us are under many different kinds of pressures about these issues. There can be pressure from our friends for participating in many activities, whether we really want to or not. There can be pressure from families to get married and start having children. There can be pressure from government agencies to avoid having children. In this situation, making choices can become very difficult.

We must also consider the possible health consequences of having sex. We have discussed in Class IX that diseases can be transmitted from person to person in a variety of ways. Since the sexual act is a very intimate connection of bodies, it is not surprising that many diseases can be sexually transmitted. These include bacterial infections such as gonorrhoea and syphilis, and viral infections such as warts and HIV-AIDS. Is it possible to prevent the transmission of such diseases during the sexual act? Using a covering, called a condom, for the penis during sex helps to prevent transmission of many of these infections to some extent.

The sexual act always has the potential to lead to pregnancy. Pregnancy will make major demands on the body and the mind of the woman, and if she is not ready for it, her health will be adversely affected. Therefore, many ways have been devised to avoid pregnancy. These contraceptive methods fall in a number of categories. One category is the creation of a mechanical barrier so that sperm does not reach the egg. Condoms on the penis or similar coverings worn in the vagina can serve this purpose. Another category of contraceptives acts by changing the hormonal balance of the body so that eggs are not released and fertilisation cannot occur. These drugs commonly need to be taken orally as pills. However, since they change hormonal balances, they can cause side-effects too. Other contraceptive devices such as the loop or the copper-T are placed in the uterus to prevent pregnancy. Again, they can cause side effects due to irritation of the uterus. If the vas deferens in the male is blocked, sperm transfer will be prevented. If the fallopian tube in the female is blocked, the egg will not be able to reach the uterus. In both cases fertilisation will not take place. Surgical methods can be used to create such blocks. While surgical methods are safe in the long run, surgery itself can cause infections and other problems if not performed properly. Surgery can also be used for removal of unwanted pregnancies. These may be misused by people who do not want a particular child, as happens in illegal sex-selective abortion of female foetuses. For a healthy society, the female-male sex ratio must be maintained. Because of reckless female foeticides, child sex ratio is declining at an alarming rate in some sections of our society, although prenatal sex determination has been prohibited by law.

We have noted earlier that reproduction is the process by which organisms increase their populations. The rates of birth and death in a given population will determine its size. The size of the human population is a cause for concern for many people. This is because an expanding population makes it harder to improve everybody's standard of living. However, if inequality in society is the main reason for poor standards of living for many people, the size of the population is relatively unimportant. If we look around us, what can we identify as the most important reason(s) for poor living standards?

Q U E S T I O N S

1. How is the process of pollination different from fertilisation?
2. What is the role of the seminal vesicles and the prostate gland?
3. What are the changes seen in girls at the time of puberty?
4. How does the embryo get nourishment inside the mother's body?
5. If a woman is using a copper-T, will it help in protecting her from sexually transmitted diseases?



What you have learnt

- Reproduction, unlike other life processes, is not essential to maintain the life of an individual organism.
- Reproduction involves creation of a DNA copy and additional cellular apparatus by the cell involved in the process.
- Various organisms use different modes of reproduction depending on their body design.
- In fission, many bacteria and protozoa simply divide into two or more daughter cells.
- Organisms such as hydra can regenerate if they are broken into pieces. They can also give out buds which mature into new individuals.
- Roots, stems and leaves of some plants develop into new plants through vegetative propagation.
- These are examples of asexual reproduction where new generations are created from a single individual.
- Sexual reproduction involves two individuals for the creation of a new individual.
- DNA copying mechanisms creates variations which are useful for ensuring the survival of the species. Modes of sexual reproduction allow for greater variation to be generated.
- Reproduction in flowering plants involves transfer of pollen grains from the anther to the stigma which is referred to as pollination. This is followed by fertilisation.
- Changes in the body at puberty, such as increase in breast size in girls and new facial hair growth in boys, are signs of sexual maturation.
- The male reproductive system in human beings consists of testes which produce sperms, vas deferens, seminal vesicles, prostate gland, urethra and penis.
- The female reproductive system in human beings consists of ovaries, fallopian tubes, uterus and vagina.
- Sexual reproduction in human beings involves the introduction of sperm in the vagina of the female. Fertilisation occurs in the fallopian tube.
- Contraception to avoid pregnancy can be achieved by the use of condoms, oral pills, copper-T and other methods.

E X E R C I S E S

1. Asexual reproduction takes place through budding in
 - (a) *amoeba*.
 - (b) yeast.
 - (c) *plasmodium*.
 - (d) *leishmania*.
2. Which of the following is not a part of the female reproductive system in human beings?
 - (a) Ovary
 - (b) Uterus
 - (c) Vas deferens
 - (d) Fallopian tube
3. The anther contains
 - (a) sepals.
 - (b) ovules.
 - (c) pistil.
 - (d) pollen grains.
4. What are the advantages of sexual reproduction over asexual reproduction?
5. What are the functions performed by the testis in human beings?
6. Why does menstruation occur?
7. Draw a labelled diagram of the longitudinal section of a flower.
8. What are the different methods of contraception?
9. How are the modes for reproduction different in unicellular and multicellular organisms?
10. How does reproduction help in providing stability to populations of species?
11. What could be the reasons for adopting contraceptive methods?



1064CH09



CHAPTER 9

Heredity and Evolution

We have seen that reproductive processes give rise to new individuals that are similar, but subtly different. We have discussed how some amount of variation is produced even during asexual reproduction. And the number of successful variations are maximised by the process of sexual reproduction. If we observe a field of sugarcane we find very little variations among the individual plants. But in a number of animals including human beings, which reproduce sexually, quite distinct variations are visible among different individuals. In this chapter, we shall be studying the mechanism by which variations are created and inherited. The long-term consequences of the accumulation of variations are also an interesting point to be considered. We shall be studying this under evolution.

9.1 ACCUMULATION OF VARIATION DURING REPRODUCTION

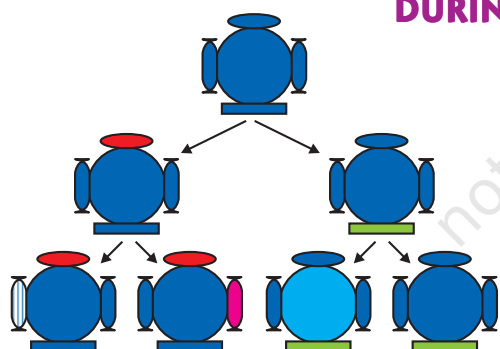

Figure 9.1
Creation of diversity over succeeding generations. The original organism at the top will give rise to, say, two individuals, similar in body design, but with subtle differences. Each of them, in turn, will give rise to two individuals in the next generation. Each of the four individuals in the bottom row will be different from each other. While some of these differences will be unique, others will be inherited from their respective parents, who were different from each other.

Inheritance from the previous generation provides both a common basic body design, and subtle changes in it, for the next generation. Now think about what would happen when this new generation, in its turn, reproduces. The second generation will have differences that they inherit from the first generation, as well as newly created differences (Fig. 9.1).

Figure 9.1 would represent the situation if a single individual reproduces, as happens in asexual reproduction. If one bacterium divides, and then the resultant two bacteria divide again, the four individual bacteria generated would be very similar. There would be only very minor differences between them, generated due to small inaccuracies in DNA copying. However, if sexual reproduction is involved, even greater diversity will be generated, as we will see when we discuss the rules of inheritance.

Do all these variations in a species have equal chances of surviving in the environment in which they find themselves? Obviously not. Depending on the nature of variations, different individuals would have

different kinds of advantages. Bacteria that can withstand heat will survive better in a heat wave, as we have discussed earlier. Selection of variants by environmental factors forms the basis for evolutionary processes, as we will discuss in later sections.

Q U E S T I O N S

1. If a trait A exists in 10% of a population of an asexually reproducing species and a trait B exists in 60% of the same population, which trait is likely to have arisen earlier?
2. How does the creation of variations in a species promote survival?



9.2 HEREDITY

The most obvious outcome of the reproductive process still remains the generation of individuals of similar design. The rules of heredity determine the process by which traits and characteristics are reliably inherited. Let us take a closer look at these rules.

9.2.1 Inherited Traits

What exactly do we mean by similarities and differences? We know that a child bears all the basic features of a human being. However, it does not look exactly like its parents, and human populations show a great deal of variation.

Activity 9.1

- Observe the ears of all the students in the class. Prepare a list of students having free or attached earlobes and calculate the percentage of students having each (Fig. 9.2). Find out about the earlobes of the parents of each student in the class. Correlate the earlobe type of each student with that of their parents. Based on this evidence, suggest a possible rule for the inheritance of earlobe types.



(a)



(b)

9.2.2 Rules for the Inheritance of Traits – Mendel's Contributions

The rules for inheritance of such traits in human beings are related to the fact that both the father and the mother contribute practically equal amounts of genetic material to the child. This means that each trait can be influenced by both paternal and maternal DNA. Thus, for each trait there will be two versions in each child. What will, then, the trait seen in the child be? Mendel (see box) worked out the main rules of such inheritance, and it is interesting to look at some of his experiments from more than a century ago.

Figure 9.2

(a) Free and (b) attached earlobes. The lowest part of the ear, called the earlobe, is closely attached to the side of the head in some of us, and not in others. Free and attached earlobes are two variants found in human populations.

Gregor Johann Mendel (1822–1884)

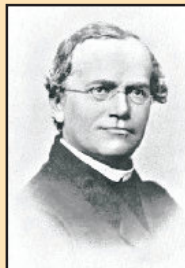

Mendel was educated in a monastery and went on to study science and mathematics at the University of Vienna. Failure in the examinations for a teaching certificate did not suppress his zeal for scientific quest. He went back to his monastery and started growing peas. Many others had studied the inheritance of traits in peas and other organisms earlier, but Mendel blended his knowledge of science and mathematics and was the first one to keep count of individuals exhibiting a particular trait in each generation. This helped him to arrive at the laws of inheritance.

Mendel used a number of contrasting visible characters of garden peas – round/wrinkled seeds, tall/short plants, white/violet flowers and so on. He took pea plants with different characteristics – a tall plant and a short plant, produced progeny by crossing them, and calculated the percentages of tall or short progeny.

In the first place, there were no halfway characteristics in this first-generation, or F1 progeny – no ‘medium-height’ plants. All plants were tall. This meant that only one of the parental traits was seen, not some mixture of the two. So the next question was, were the tall plants in the F1 generation exactly the same as the tall plants of the parent generation? Mendelian experiments test this by getting both the parental plants and these F1 tall plants to reproduce by self-pollination. The progeny of the parental plants are, of course, all tall. However, the second-generation, or F2, progeny of the F1 tall plants are not all tall. Instead, one quarter of them are short. This indicates that both the tallness and shortness traits were inherited in the F1 plants, but only the tallness trait was expressed. This led Mendel to propose that two copies of factor (now called genes) controlling traits are present in sexually reproducing organism. These two may be identical, or may be different, depending on the parentage. A pattern of inheritance can be worked out with this assumption, as shown in Fig. 9.3.

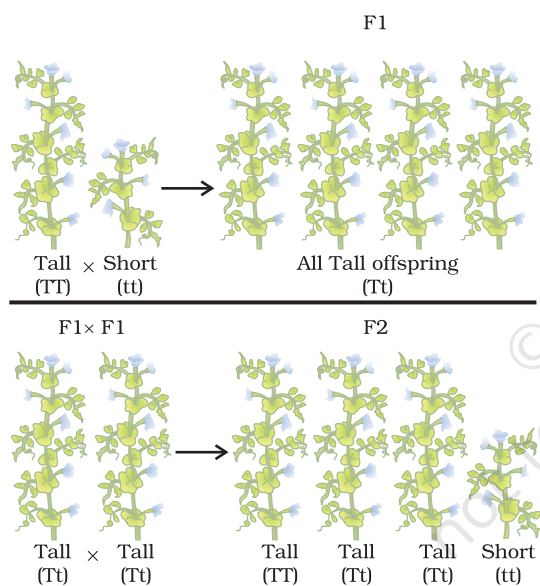

Figure 9.3
Inheritance of traits
over two generations

Activity 9.2

- In Fig. 9.3, what experiment would we do to confirm that the F2 generation did in fact have a 1:2:1 ratio of TT, Tt and tt trait combinations?

In this explanation, both TT and Tt are tall plants, while only tt is a short plant. In other words, a single copy of ‘T’ is enough to make the plant tall, while both copies have to be ‘t’ for the plant to be short. Traits like ‘T’ are called dominant traits, while those that behave like ‘t’ are called recessive traits. Work out which trait would be considered dominant and which one recessive in Fig. 9.4.

What happens when pea plants showing two different characteristics, rather than just one, are bred with each other? What do the progeny of a tall plant with round seeds and a short plant with wrinkled-seeds look like? They are all tall and have round seeds. Tallness and round seeds are thus dominant traits. But what happens when these F1 progeny are used to generate F2 progeny by self-pollination? A Mendelian experiment will find that some F2 progeny are tall plants with round seeds, and some were short plants with wrinkled seeds. However, there would also be some F2 progeny that showed new combinations. Some of them would be tall, but have wrinkled seeds, while others would be short, but have round seeds. You can see as to how new combinations of traits are formed in F2 offspring when factors controlling for seed shape and seed colour recombine to form zygote leading to form F2 offspring (Fig. 9.5). Thus, the tall/short trait and the round seed/wrinkled seed trait are independently inherited.

9.2.3 How do these Traits get Expressed?

How does the mechanism of heredity work? Cellular DNA is the information source for making proteins in the cell. A section of DNA that provides information for one protein is called the gene for that protein. How do proteins control the characteristics that we are discussing here? Let us take the example of tallness as a characteristic. We know that plants have hormones that can trigger growth. Plant height can thus depend on the amount of a particular plant hormone. The amount of the plant hormone made will depend on the efficiency of the process for making it. Consider now an enzyme that is important for this process. If this enzyme works efficiently, a lot of hormone will be made, and the plant will be tall. If the gene for that enzyme has an alteration that makes the enzyme less efficient, the amount of hormone will be less, and the plant will be short. Thus, genes control characteristics, or traits.

If the interpretations of Mendelian experiments we have been discussing are correct, then both parents must be contributing equally to the DNA of the progeny during sexual reproduction. We have discussed this issue in the previous Chapter. If both parents can help determine the trait in the progeny, both parents must be contributing a copy of the same gene. This means that each pea plant must have two sets of all genes, one inherited from each parent. For this mechanism to work, each germ cell must have only one gene set.

How do germ-cells make a single set of genes from the normal two copies that all other cells in the body have? If progeny plants inherited a single whole gene set from each parent, then the experiment explained in Fig. 9.5 cannot work. This is because the two characteristics 'R' and 'y' would then be linked to each other and cannot be independently

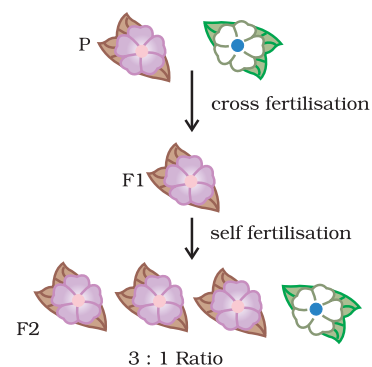

Figure 9.4

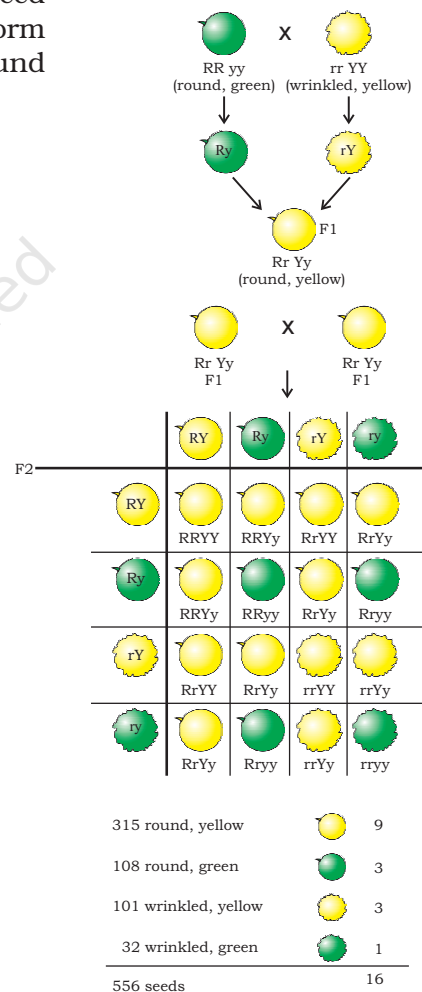
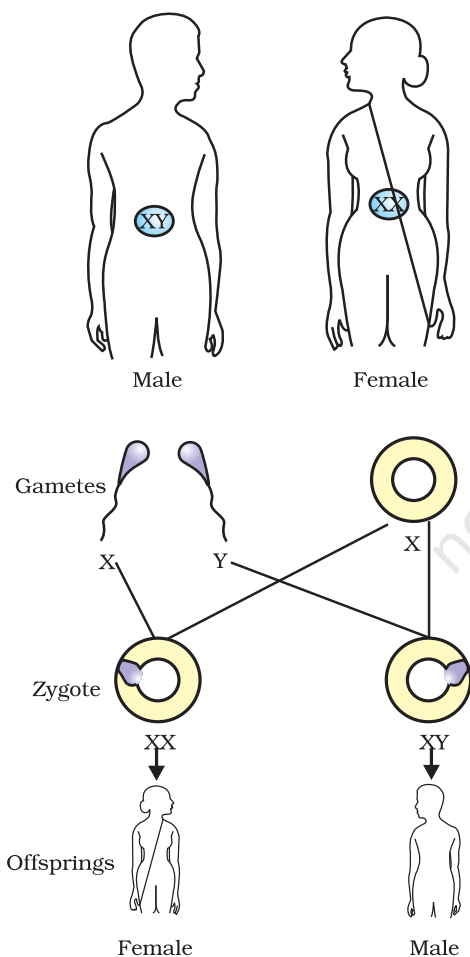

Figure 9.5
Independent inheritance of two separate traits, shape and colour of seeds

inherited. This is explained by the fact that each gene set is present, not as a single long thread of DNA, but as separate independent pieces, each called a chromosome. Thus, each cell will have two copies of each chromosome, one each from the male and female parents. Every germ-cell will take one chromosome from each pair and these may be of either maternal or paternal origin. When two germ cells combine, they will restore the normal number of chromosomes in the progeny, ensuring the stability of the DNA of the species. Such a mechanism of inheritance explains the results of the Mendel experiments, and is used by all sexually reproducing organisms. But asexually reproducing organisms also follow similar rules of inheritance. Can we work out how their inheritance might work?

9.2.4 Sex Determination

We have discussed the idea that the two sexes participating in sexual reproduction must be somewhat different from each other for a number



of reasons. How is the sex of a newborn individual determined? Different species use very different strategies for this. Some rely entirely on environmental cues. Thus, in some animals like a few reptiles, the temperature at which fertilised eggs are kept determines whether the animals developing in the eggs will be male or female. In other animals, such as snails, individuals can change sex, indicating that sex is not genetically determined. However, in human beings, the sex of the individual is largely genetically determined. In other words, the genes inherited from our parents decide whether we will be boys or girls. But so far, we have assumed that similar gene sets are inherited from both parents. If that is the case, how can genetic inheritance determine sex?

The explanation lies in the fact that all human chromosomes are not paired. Most human chromosomes have a maternal and a paternal copy, and we have 22 such pairs. But one pair, called the sex chromosomes, is odd in not always being a perfect pair. Women have a perfect pair of sex chromosomes, both called X. But men have a mismatched pair in which one is a normal-sized X while the other is a short one called Y. So women are XX, while men are XY. Now, can we work out what the inheritance pattern of X and Y will be?

As Fig. 9.6 shows, half the children will be boys and half will be girls. All children will inherit an X chromosome from their mother regardless of whether they are boys or girls. Thus, the sex of the children will be determined by what they inherit from their father. A child who inherits an X chromosome from her father will be a girl, and one who inherits a Y chromosome from him will be a boy.

Figure 9.6
Sex determination in human beings

Q U E S T I O N S

1. How do Mendel's experiments show that traits may be dominant or recessive?
2. How do Mendel's experiments show that traits are inherited independently?
3. A man with blood group A marries a woman with blood group O and their daughter has blood group O. Is this information enough to tell you which of the traits – blood group A or O – is dominant? Why or why not?
4. How is the sex of the child determined in human beings?



9.3 EVOLUTION

We have noted that there is an inbuilt tendency to variation during reproduction, both because of errors in DNA copying, and as a result of sexual reproduction. Let us now look at some consequences of this tendency.

9.3.1 An Illustration

Consider a group of twelve red beetles. They live, let us assume, in some bushes with green leaves. Their population will grow by sexual reproduction, and therefore, can generate variations. Let us imagine also that crows eat these beetles. The more beetles the crows eat, the fewer beetles are available to reproduce. Now, let us think about some different situations (Fig. 9.7) that can develop in this beetle population.

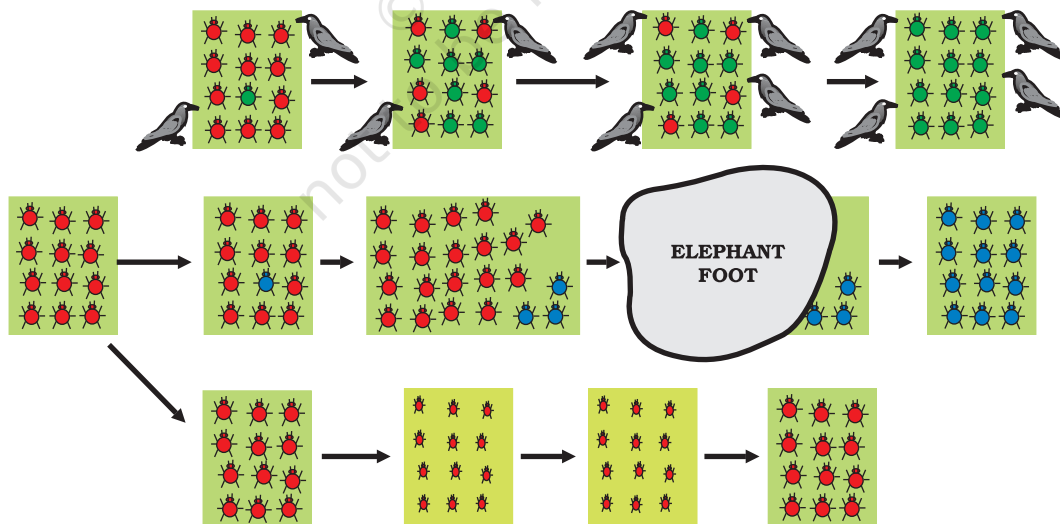

Figure 9.7 Variations in a population – inherited and otherwise

In the first situation, a colour variation arises during reproduction, so that there is one beetle that is green in colour instead of red. This beetle, moreover, can pass the colour on to its progeny, so that all its

progeny beetles are green. Crows cannot see green-coloured beetles on the green leaves of the bushes, and therefore cannot eat them. What happens then? The progeny of green beetles is not eaten, while the progeny of red beetles continues to be eaten. As a result, there are more and more green beetles than red ones in the beetle population.

In a second situation, again, a colour variation arises during reproduction, but now it results in a beetle that is blue in colour instead of red. This beetle can also pass the colour on to its progeny, so that all its progeny beetles are blue. Crows can see blue-coloured beetles in the green leaves of the bushes as well as they can see red ones, and therefore can eat them. What happens initially? In the population, as it expands, there are a few blue beetles, but most are red. But at this point, an elephant comes by, and stamps on the bushes where the beetles live. This kills most of the beetles. By chance, the few beetles that have survived are mostly blue. The beetle population slowly expands again, but now, the beetles in the population are mostly blue.

It is obvious that in both situations, what started out as a rare variation came to be a common characteristic in the population. In other words, the frequency of an inherited trait changed over generations. Since genes control traits, we can say that the frequency of certain genes in a population changed over generations. This is the essence of the idea of evolution.

But there are interesting differences, too, in the two situations. In the first case, the variation became common because it gave a survival advantage. In other words, it was naturally selected. We can see that the natural selection is exerted by the crows. The more crows there are, the more red beetles would be eaten, and the more the proportion of green beetles in the population would be. Thus, natural selection is directing evolution in the beetle population. It results in adaptations in the beetle population to fit their environment better.

In the second situation, the colour change gave no survival advantage. Instead, it was simply a matter of accidental survival of beetles of one colour that changed the common characteristic of the resultant population. The elephant would not have caused such major havoc in the beetle population if the beetle population had been very large. So, accidents in small populations can change the frequency of some genes in a population, even if they give no survival advantage. This is the notion of genetic drift, which provides diversity without any adaptations.

Now consider a third situation. In this, as the beetle population begins to expand, the bushes start suffering from a plant disease. The amount of leaf material for the beetles is reduced. The beetles are poorly nourished as a result. The average weight of adult beetles decreases from what it used to be when leaves were plentiful, but there is no genetic change occurring. After a few years and a few beetle generations of such scarcity, the plant disease is eliminated. There is a lot of leaf food. At this time, what would we expect the weight of the beetles to be?

9.3.2 Acquired and Inherited Traits

We discussed the idea that the germ cells of sexually reproducing populations are made in specialised reproductive tissue. If the weight of the beetle is reduced because of starvation, that will not change the DNA of the germ cells. Therefore, low weight is not a trait that can be inherited by the progeny of a starving beetle. Therefore, even if some generations of beetles are low in weight because of starvation, that is not an example of evolution, since the change is not inherited over generations. Change in non-reproductive tissues cannot be passed on to the DNA of the germ cells. Therefore the experiences of an individual during its lifetime cannot be passed on to its progeny, and cannot direct evolution.

Consider another example of how an individual cannot pass on to its progeny the experiences of its lifetime. If we breed a group of mice, all their progeny will have tails, as expected. Now, if the tails of these mice are removed by surgery in each generation, do these tailless mice have tailless progeny? The answer is no, and it makes sense because removal of the tail cannot change the genes of the germ cells of the mice.

Charles Robert Darwin (1809–1882)

Charles Darwin set out on a voyage when he was 22 years old. The five-year voyage took him to South America and the islands off its coast. The studies that he conducted during this voyage were to change forever the way we look at the variety of life on earth. Interestingly, after he got back to England, he never left its shores again. He stayed at home and conducted various experiments that led him to formulate his hypothesis that evolution took place due to natural selection. He did not know the mechanism whereby variations arose in the species. He would have been enlightened by Mendel's experiments, but these two gentlemen did not know of each other or their work!

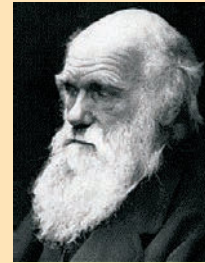

We often associate Darwin solely with the theory of evolution. But he was an accomplished naturalist, and one of the studies he conducted was to do with the role of earthworms in soil fertility.

This is the reason why the ideas of heredity and genetics that we have discussed earlier are so essential for understanding evolution. Even Charles Darwin, who came up with the idea of evolution of species by natural selection in the nineteenth century, could not work out the mechanism. It is ironic that he could have done so if he had seen the significance of the experiments his Austrian contemporary, Gregor Mendel, was doing. But then, Mendel too did not notice Darwin's work as relevant to his!

Origin of life on earth

Darwin's theory of evolution tells us how life evolved from simple to more complex forms and Mendel's experiments give us the mechanism for the inheritance of traits from one generation to the next. But neither tells us anything about how life began on earth in the first place.

J.B.S. Haldane, a British scientist (who became a citizen of India later), suggested in 1929 that life must have developed from the simple inorganic molecules which were present on earth soon after it was formed. He speculated that the conditions on earth at that time, which were far from the conditions we see today, could have given rise to more complex organic molecules that were necessary for life. The first primitive organisms would arise from further chemical synthesis.

How did these organic molecules arise? An answer was suggested by the experiment conducted by Stanley L. Miller and Harold C. Urey in 1953. They assembled an atmosphere similar to that thought to exist on early earth (this had molecules like ammonia, methane and hydrogen sulphide, but no oxygen) over water. This was maintained at a temperature just below 100°C and sparks were passed through the mixture of gases to simulate lightning. At the end of a week, 15% of the carbon (from methane) had been converted to simple compounds of carbon including amino acids which make up protein molecules. So, can life arise afresh on earth even now?

Q U E S T I O N S

1. What are the different ways in which individuals with a particular trait may increase in a population?
2. Why are traits acquired during the life-time of an individual not inherited?
3. Why are the small numbers of surviving tigers a cause of worry from the point of view of genetics?



9.4 SPECIATION

What we have seen so far is micro-evolution. That means that the changes are small, even though they are significant. Also, they simply change the common characteristics of a particular species. But this does not properly explain as to how new species come into existence. That can be said to have happened only if this group of beetles we are thinking about, splits into two populations that cannot reproduce with each other. When this happens, they can be called two independent species. So, can we extend the reasoning we have used above to explain such speciation?

Consider what would happen if the bushes the beetles feed on are spread widely over a mountain range. The beetle population becomes very large as a result. But individual beetles feed mostly on a few nearby bushes throughout their lifetime. They do not travel far. So, in this huge population of beetles, there will be sub-populations in neighbourhoods. Since male and female beetles have to meet for reproduction to happen, most reproduction will be within these sub-populations. Of course, an occasional adventurous beetle might go from one site to another. Or a beetle is picked up by a crow from one site and dropped in the other site without being eaten. In either case, the migrant beetle will reproduce with the local population. This will result in the genes of the migrant beetle entering a new population. This kind of gene flow is bound to

happen between populations that are partly, but not completely separated. If, however, between two such sub-populations a large river comes into existence, the two populations will be further isolated. The levels of gene flow between them will decrease even further.

Over generations, genetic drift will accumulate different changes in each sub-population. Also, natural selection may also operate differently in these different geographic locations. Thus, for example, in the territory of one sub-population, crows are eliminated by eagles. But this does not happen for the other sub-population, where crow numbers are very high. As a result, the green variation will not be selected at the first site, while it will be strongly selected at the second.

Together, the processes of genetic drift and natural selection will result in these two isolated sub-populations of beetles becoming more and more different from each other. Eventually, members of these two groups will be incapable of reproducing with each other even if they happen to meet.

There can be a number of ways by which this can happen. If the DNA changes are severe enough, such as a change in the number of chromosomes, eventually the germ cells of the two groups cannot fuse with each other. Or a new variation emerges in which green females will not mate with red males, but only with green males. This allows very strong natural selection for greenness. Now, if such a green female beetle meets a red male from the other group, her behaviour will ensure that there is no reproduction between them. Effectively, new species of beetles are being generated.

Q U E S T I O N S

1. What factors could lead to the rise of a new species?
2. Will geographical isolation be a major factor in the speciation of a self-pollinating plant species? Why or why not?
3. Will geographical isolation be a major factor in the speciation of an organism that reproduces asexually? Why or why not?



9.5 EVOLUTION AND CLASSIFICATION

Based on these principles, we can work out the evolutionary relationships of the species we see around us. It is a sort of going backwards in time. We can do this by identifying hierarchies of characteristics between species. In order to understand this process, let us think back to our discussion on the classification of organisms in Class IX.

Similarities among organisms will allow us to group them and then study the groups. For this, which characteristics decide more fundamental differences among organisms, and which ones decide less basic differences? What is meant by 'characteristics', anyway? Characteristics are details of appearance or behaviour; in other words, a particular form or a particular function. That we have four limbs is thus a characteristic. That plants can do photosynthesis is also a characteristic.

Some basic characteristics will be shared by most organisms. The cell is the basic unit of life in all organisms. The characteristics in the next level of classification would be shared by most, but not all organisms. A basic characteristic of cell design that differs among different organisms is whether the cell has a nucleus. Bacterial cells do not, while the cells of most other organisms do. Among organisms with nucleated cells, which ones are unicellular and which ones multi-cellular? That property marks a very basic difference in body design, because of specialisation of cell types and tissues. Among multi-cellular organisms, whether they can undertake photosynthesis or not will provide the next level of classification. Among the multi-cellular organisms that cannot do photosynthesis, whether the skeleton is inside the body or around the body will mark another fundamental design difference. We can see that, even in these few questions that we have asked, a hierarchy is developing that allows us to make classification groups.

The more characteristics two species will have in common, the more closely they are related. And the more closely they are related, the more recently they will have had a common ancestor. An example will help. A brother and a sister are closely related. They have common ancestors in the first generation before them, namely, their parents. A girl and her first cousin are also related, but less than the girl and her brother. This is because cousins have common ancestors, their grandparents, in the second generation before them, not in the first one. We can now appreciate that classification of species is in fact a reflection of their evolutionary relationship.

We can thus build up small groups of species with recent common ancestors, then super-groups of these groups with more distant common ancestors, and so on. In theory, we can keep going backwards like this until we come to the notion of a single species at the very beginning of evolutionary time. If that is the case, then at some point in the history of the earth, non-living material must have given rise to life. There are many theories about how this might have happened. It would be interesting to come up with theories of our own!

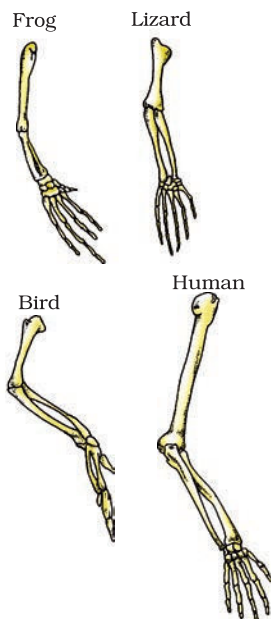

Figure 9.8
Homologous organs

9.5.1 Tracing Evolutionary Relationships

When we try to follow evolutionary relationships, how do we identify characteristics as common? These characteristics in different organisms would be similar because they are inherited from a common ancestor. As an example, consider the fact that mammals have four limbs, as do birds, reptiles and amphibians (Fig. 9.8). The basic structure of the limbs is similar though it has been modified to perform different functions in various vertebrates. Such a homologous characteristic helps to identify an evolutionary relationship between apparently different species.

However, all similarities simply in organ shape are not necessarily because of common ancestry. What would we think about the wings of

birds and bats, for example (Fig. 9.9)? Birds and bats have wings, but squirrels and lizards do not. So are birds and bats more closely related to each other than to squirrels or lizards?

Before we jump to this conclusion, let us look at the wings of birds and bats more closely. When we do that, we find that the wings of bats are skin folds stretched mainly between elongated fingers. But the wings of birds are a feathery covering all along the arm. The designs of the two wings, their structure and components, are thus very different. They look similar because they have a common use for flying, but their origins are not common. This makes them analogous characteristics, rather than homologous characteristics. It would now be interesting to think about whether bird arms and bat arms should be considered homologous or analogous!

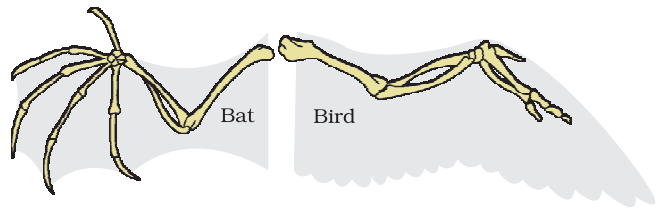

Figure 9.9
Analogous organs – The wing of a bat and the wing of a bird

9.5.2 Fossils

Such studies of organ structure can be done not only on current species, but also on species that are no longer alive. How do we know that these extinct species ever existed? We know this from finding fossils (Fig. 9.10). What are fossils? Usually, when organisms die, their bodies will decompose and be lost. But every once in a while, the body or at least some parts may be in an environment that does not let it decompose completely. If a dead insect gets caught in hot mud, for example, it will not decompose quickly, and the mud will eventually harden and retain the impression of the body parts of the insect. All such preserved traces of living organisms are called fossils.



Fossil – tree trunk



Fossil – invertebrate (Ammonite)



Fossil – invertebrate (Trilobite)



Fossil – fish (Knightia)



Fossil – dinosaur skull (Rajasaurus)

Figure 9.10 Various kind of fossils. Note the different appearances and degrees of detail and preservation. The dinosaur skull fossil shown was found only a few years ago in the Narmada valley.

How do we know how old the fossils are? There are two components to this estimation. One is relative. If we dig into the earth and start finding fossils, it is reasonable to suppose that the fossils we find closer to the surface are more recent than the fossils we find in deeper layers. The second way of dating fossils is by detecting the ratios of different isotopes of the same element in the fossil material. It would be interesting to find out exactly how this method works!

How do fossils form layer by layer?



Let us start 100 million years ago. Some invertebrates on the sea-bed die, and are buried in the sand. More sand accumulates, and sandstone forms under pressure.

Millions of years later, dinosaurs living in the area die, and their bodies, too, are buried in mud. This mud is also compressed into rock, above the rock containing the earlier invertebrate fossils.

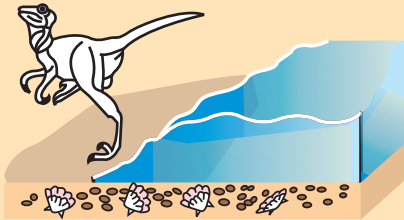

Again millions of years later, the bodies of horse-like creatures dying in the area are fossilised in rocks above these earlier rocks.



Much later, by erosion or water flow wears away some of the rock and exposes the horse-like fossils. As we dig deeper, we will find older and older fossils.

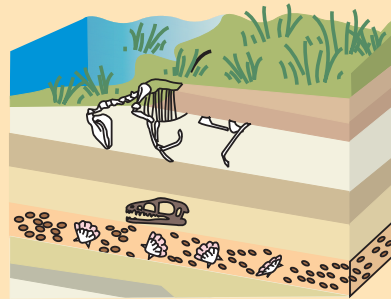

9.5.3 Evolution by Stages

A question that arises here is – if complicated organs, such as the eye, are selected for the advantage they provide, how can they be generated by a single DNA change? Surely such complex organs will be created bit-by-bit over generations? But how can each intermediate change be selected for? There are a number of possible explanations. Even an intermediate stage (Fig. 9.11), such as a rudimentary eye, can be useful to some extent. This might be enough to give a fitness advantage. In fact, the eye – like the wing – seems to be a very popular adaptation. Insects have them, so does an octopus, and so do vertebrates. And the structure of the eye in each of these organisms is different – enough for them to have separate evolutionary origins.

Also, a change that is useful for one property to start with can become useful later for quite a different function. Feathers, for example, can start out as providing insulation in cold weather (Fig. 9.12). But later, they might become useful for flight. In fact, some dinosaurs had feathers, although they could not fly using the feathers. Birds seem to have later adapted the feathers to flight. This, of course, means that birds are very closely related to reptiles, since dinosaurs were reptiles!

It is all very well to say that very dissimilar-looking structures evolve from a common ancestral design. It is true that analysis of the organ structure in fossils allows us to make estimates of how far back evolutionary relationships go. But those are guesses about what happened in history. Are there any current examples of such a process? The wild cabbage plant is a good example. Humans have, over more than two thousand years, cultivated wild cabbage as a food plant, and generated different vegetables from it by selection (see Fig. 9.13). This is, of course, artificial selection rather than natural selection. So some farmers have wanted to select for very short distances between leaves, and have bred the cabbage we eat. Some have wanted to select for arrested flower development, and have bred broccoli, or for sterile flowers, and have made the cauliflower. Some have selected for swollen parts, and come up with kohlrabi. Some have simply looked for slightly larger leaves, and come up with a leafy vegetable called kale. Would we have thought that all these structures are descended from the same ancestor if we had not done it ourselves?

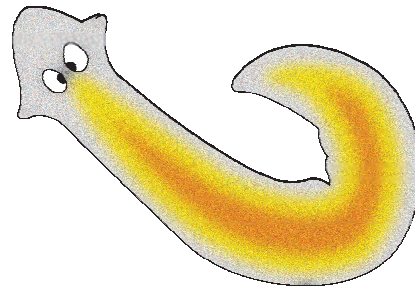
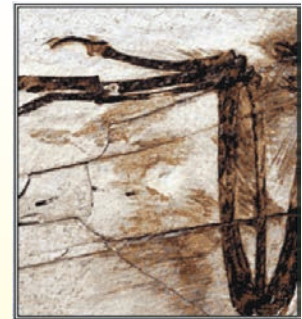

Figure 9.11

A flatworm named *Planaria* has very simple 'eyes' that are really just eye-spots which detect light.



This is a small dinosaur from the Dromaeosaur family.



Feather imprints were preserved along this dinosaur's bones. Here we can see feathers on the forearm.

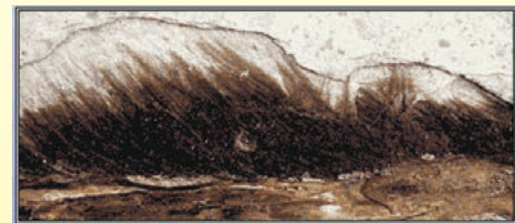

Here's a close-up of the fossil's head feathers.

This dinosaur could not fly, and it is possible that the evolution of feathers had nothing to do with flight.

Figure 9.12

Dinosaurs and the evolution of feathers

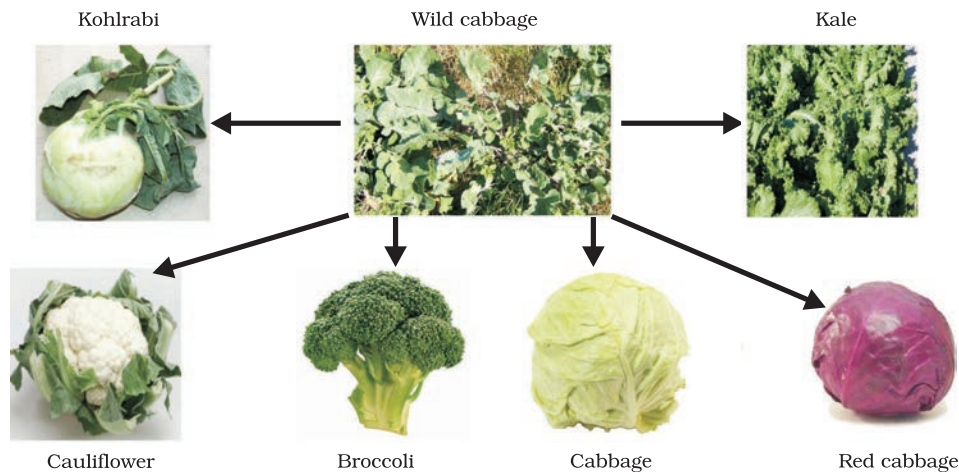

Figure 9.13 Evolution of wild cabbage!

Another way of tracing evolutionary relationships depends on the original idea that we started with. That idea was that changes in DNA during reproduction are the basic events in evolution. If that is the case, then comparing the DNA of different species should give us a direct estimate of how much the DNA has changed during the formation of these species. This method is now extensively used to define evolutionary relationships.

More to Know!

Molecular phylogeny

We have been discussing how changes in the DNA during cell division would lead to changes in the proteins that are made from this new DNA. Another point that has been made is that these changes would accumulate from one generation to the next. Could this be used to trace the changes in DNA backwards in time and find out where each change diverged from the other? Molecular phylogeny does exactly this. This approach is based on the idea that organisms which are more distantly related will accumulate a greater number of differences in their DNA. Such studies trace the evolutionary relationships and it has been highly gratifying to find that the relationships among different organisms shown by molecular phylogeny match the classification scheme that we learnt in Class IX.

Q U E S T I O N S

1. Give an example of characteristics being used to determine how close two species are in evolutionary terms.
2. Can the wing of a butterfly and the wing of a bat be considered homologous organs? Why or why not?
3. What are fossils? What do they tell us about the process of evolution?



9.6 EVOLUTION SHOULD NOT BE EQUATED WITH 'PROGRESS'

In an exercise of tracing the family trees of species, we need to remember certain things. Firstly, there are multiple branches possible at each and

every stage of this process. So it is not as if one species is eliminated to give rise to a new one. A new species has emerged. But that does not necessarily mean, like the beetle example we have been thinking about, that the old species will disappear. It will all depend on the environment. Also, it is not as if the newly generated species are in any way 'better' than the older one. It is just that natural selection and genetic drift have together led to the formation of a population that cannot reproduce with the original one. So, for example, it is not true that human beings have evolved from chimpanzees. Rather, both human beings and chimpanzees have a common ancestor a long time ago. That common ancestor is likely to have been neither human or chimpanzee. Also, the first step of separation from that ancestor is unlikely to have resulted in modern chimpanzees and human beings. Instead, the two resultant species have probably evolved in their own separate ways to give rise to the current forms.

In fact, there is no real 'progress' in the idea of evolution. Evolution is simply the generation of diversity and the shaping of the diversity by environmental selection. The only progressive trend in evolution seems to be that more and more complex body designs have emerged over time. However, again, it is not as if the older designs are inefficient! So many of the older and simpler designs still survive. In fact, one of the simplest life forms – bacteria – inhabit the most inhospitable habitats like hot springs, deep-sea thermal vents and the ice in Antarctica. In other words, human beings are not the pinnacle of evolution, but simply yet another species in the teeming spectrum of evolving life.

9.6.1 Human Evolution

The same tools for tracing evolutionary relationships – excavating, time-dating and studying fossils, as well as determining DNA sequences – have been used for studying human evolution. There is a great diversity of human forms and features across the planet. So much so that, for a long time, people used to talk about human 'races'. Skin colour used to be the commonest way of identifying these so-called races. Some were called yellow, some black, white or brown. A major question debated for a long time was, have these apparent groups evolved differently? Over recent years, the evidence has become very clear. The answer is that there is no biological basis to the notion of human races. All humans are a single species.

Not only that, regardless of where we have lived for the past few thousand years, we all come from Africa. The earliest members of the human species, *Homo sapiens*, can be traced there. Our genetic footprints can be traced back to our African roots. A couple of hundred thousand years ago, some of our ancestors left Africa while others stayed on. While

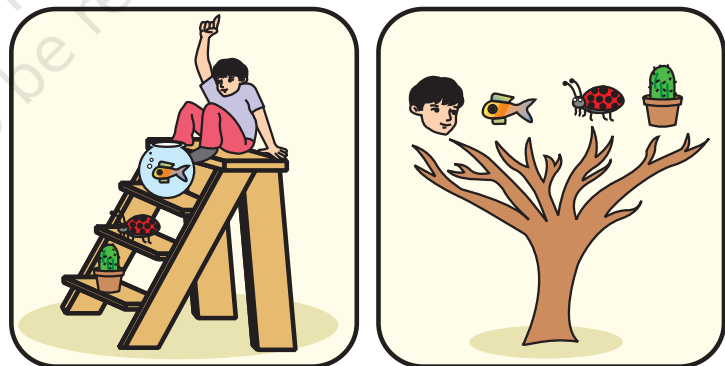

Figure 9.14
Evolution —
Ladder versus Tree

the residents spread across Africa, the migrants slowly spread across the planet – from Africa to West Asia, then to Central Asia, Eurasia, South Asia, East Asia. They travelled down the islands of Indonesia and the Philippines to Australia, and they crossed the Bering land bridge to the Americas. They did not go in a single line, so they were not travelling for the sake of travelling, obviously. They went forwards and backwards, with groups sometimes separating from each other, sometimes coming back to mix with each other, even moving in and out of Africa. Like all other species on the planet, they had come into being as an accident of evolution, and were trying to live their lives the best they could.

Q U E S T I O N S

1. Why are human beings who look so different from each other in terms of size, colour and looks said to belong to the same species?
2. In evolutionary terms, can we say which among bacteria, spiders, fish and chimpanzees have a 'better' body design? Why or why not?



What you have learnt

- Variations arising during the process of reproduction can be inherited.
- These variations may lead to increased survival of the individuals.
- Sexually reproducing individuals have two copies of genes for the same trait. If the copies are not identical, the trait that gets expressed is called the dominant trait and the other is called the recessive trait.
- Traits in one individual may be inherited separately, giving rise to new combinations of traits in the offspring of sexual reproduction.
- Sex is determined by different factors in various species. In human beings, the sex of the child depends on whether the paternal chromosome is X (for girls) or Y (for boys).
- Variations in the species may confer survival advantages or merely contribute to the genetic drift.
- Changes in the non-reproductive tissues caused by environmental factors are not inheritable.
- Speciation may take place when variation is combined with geographical isolation.
- Evolutionary relationships are traced in the classification of organisms.
- Tracing common ancestors back in time leads us to the idea that at some point of time, non-living material must have given rise to life.
- Evolution can be worked out by the study of not just living species, but also fossils.
- Complex organs may have evolved because of the survival advantage of even the intermediate stages.
- Organs or features may be adapted to new functions during the course of evolution. For example, feathers are thought to have been initially evolved for warmth and later adapted for flight.

- Evolution cannot be said to 'progress' from 'lower' forms to 'higher' forms. Rather, evolution seems to have given rise to more complex body designs even while the simpler body designs continue to flourish.
- Study of the evolution of human beings indicates that all of us belong to a single species that evolved in Africa and spread across the world in stages.

E X E R C I S E S

1. A Mendelian experiment consisted of breeding tall pea plants bearing violet flowers with short pea plants bearing white flowers. The progeny all bore violet flowers, but almost half of them were short. This suggests that the genetic make-up of the tall parent can be depicted as
 - (a) TTWW
 - (b) TTww
 - (c) TtWW
 - (d) TtWw
2. An example of homologous organs is
 - (a) our arm and a dog's fore-leg.
 - (b) our teeth and an elephant's tusks.
 - (c) potato and runners of grass.
 - (d) all of the above.
3. In evolutionary terms, we have more in common with
 - (a) a Chinese school-boy.
 - (b) a chimpanzee.
 - (c) a spider.
 - (d) a bacterium.
4. A study found that children with light-coloured eyes are likely to have parents with light-coloured eyes. On this basis, can we say anything about whether the light eye colour trait is dominant or recessive? Why or why not?
5. How are the areas of study – evolution and classification – interlinked?
6. Explain the terms analogous and homologous organs with examples.
7. Outline a project which aims to find the dominant coat colour in dogs.
8. Explain the importance of fossils in deciding evolutionary relationships.
9. What evidence do we have for the origin of life from inanimate matter?
10. Explain how sexual reproduction gives rise to more viable variations than asexual reproduction. How does this affect the evolution of those organisms that reproduce sexually?
11. How is the equal genetic contribution of male and female parents ensured in the progeny?
12. Only variations that confer an advantage to an individual organism will survive in a population. Do you agree with this statement? Why or why not?



1064CH10

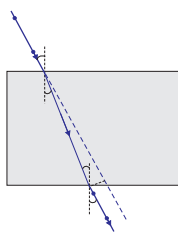

CHAPTER 10

Light – Reflection and Refraction

We see a variety of objects in the world around us. However, we are unable to see anything in a dark room. On lighting up the room, things become visible. What makes things visible? During the day, the sunlight helps us to see objects. An object reflects light that falls on it. This reflected light, when received by our eyes, enables us to see things. We are able to see through a transparent medium as light is transmitted through it. There are a number of common wonderful phenomena associated with light such as image formation by mirrors, the twinkling of stars, the beautiful colours of a rainbow, bending of light by a medium and so on. A study of the properties of light helps us to explore them.

By observing the common optical phenomena around us, we may conclude that light seems to travel in straight lines. The fact that a small source of light casts a *sharp* shadow of an opaque object points to this straight-line path of light, usually indicated as a ray of light.

More to Know!

If an opaque object on the path of light becomes *very small*, light has a tendency to bend around it and not walk in a straight line – an effect known as the diffraction of light. Then the straight-line treatment of optics using rays fails. To explain phenomena such as diffraction, light is thought of as a wave, the details of which you will study in higher classes. Again, at the beginning of the 20th century, it became known that the wave theory of light often becomes inadequate for treatment of the interaction of light with matter, and light often behaves somewhat like a *stream of particles*. This confusion about the true nature of light continued for some years till a modern quantum theory of light emerged in which light is neither a ‘wave’ nor a ‘particle’ – the new theory reconciles the particle properties of light with the wave nature.

In this Chapter, we shall study the phenomena of reflection and refraction of light using the straight-line propagation of light. These basic concepts will help us in the study of some of the optical phenomena in nature. We shall try to understand in this Chapter the reflection of light by spherical mirrors and refraction of light and their application in real life situations.

10.1 REFLECTION OF LIGHT

A highly polished surface, such as a mirror, reflects most of the light falling on it. You are already familiar with the laws of reflection of light.

Let us recall these laws –

- (i) The angle of incidence is equal to the angle of reflection, and
- (ii) The incident ray, the normal to the mirror at the point of incidence and the reflected ray, all lie in the same plane.

These laws of reflection are applicable to all types of reflecting surfaces including spherical surfaces. You are familiar with the formation of image by a plane mirror. What are the properties of the image? Image formed by a plane mirror is always virtual and erect. The size of the image is equal to that of the object. The image formed is as far behind the mirror as the object is in front of it. Further, the image is laterally inverted. How would the images be when the reflecting surfaces are curved? Let us explore.

Activity 10.1

- Take a large shining spoon. Try to view your face in its curved surface.
- Do you get the image? Is it smaller or larger?
- Move the spoon slowly away from your face. Observe the image. How does it change?
- Reverse the spoon and repeat the Activity. How does the image look like now?
- Compare the characteristics of the image on the two surfaces.

The curved surface of a shining spoon could be considered as a curved mirror. The most commonly used type of curved mirror is the spherical mirror. The reflecting surface of such mirrors can be considered to form a part of the surface of a sphere. Such mirrors, whose reflecting surfaces are spherical, are called spherical mirrors. We shall now study about spherical mirrors in some detail.

10.2 SPHERICAL MIRRORS

The reflecting surface of a spherical mirror may be curved inwards or outwards. A spherical mirror, whose reflecting surface is curved inwards, that is, faces towards the centre of the sphere, is called a concave mirror. A spherical mirror whose reflecting surface is curved outwards, is called a convex mirror. The schematic representation of these mirrors is shown in Fig. 10.1. You may note in these diagrams that the back of the mirror is shaded.

You may now understand that the surface of the spoon curved inwards can be approximated to a concave mirror and the surface of the spoon bulged outwards can be approximated to a convex mirror.

Before we move further on spherical mirrors, we need to recognise and understand the meaning of a few terms. These terms are commonly used in discussions about spherical mirrors. The centre of the reflecting surface of a spherical mirror is a point called the pole. It lies on the surface of the mirror. The pole is usually represented by the letter P.

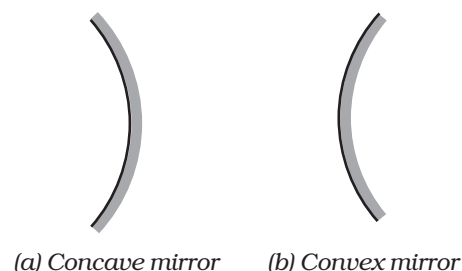

Figure 10.1
Schematic representation of spherical mirrors; the shaded side is non-reflecting.

The reflecting surface of a spherical mirror forms a part of a sphere. This sphere has a centre. This point is called the centre of curvature of the spherical mirror. It is represented by the letter C. Please note that the centre of curvature is not a part of the mirror. It lies outside its reflecting surface. The centre of curvature of a concave mirror lies in front of it. However, it lies behind the mirror in case of a convex mirror. You may note this in Fig. 10.2 (a) and (b). The radius of the sphere of which the reflecting surface of a spherical mirror forms a part, is called the radius of curvature of the mirror. It is represented by the letter R . You may note that the distance PC is equal to the radius of curvature. Imagine a straight line passing through the pole and the centre of curvature of a spherical mirror. This line is called the principal axis. Remember that principal axis is normal to the mirror at its pole. Let us understand an important term related to mirrors, through an Activity.

Activity 10.2

CAUTION: Do not look at the Sun directly or even into a mirror reflecting sunlight. It may damage your eyes.

- Hold a concave mirror in your hand and direct its reflecting surface towards the Sun.
- Direct the light reflected by the mirror on to a sheet of paper held close to the mirror.
- Move the sheet of paper back and forth gradually until you find on the paper sheet a bright, sharp spot of light.
- Hold the mirror and the paper in the same position for a few minutes. What do you observe? Why?

The paper at first begins to burn producing smoke. Eventually it may even catch fire. Why does it burn? The light from the Sun is converged at a point, as a sharp, bright spot by the mirror. In fact, this spot of light

is the image of the Sun on the sheet of paper. This point is the focus of the concave mirror. The heat produced due to the concentration of sunlight ignites the paper. The distance of this image from the position of the mirror gives the approximate value of focal length of the mirror.

Let us try to understand this observation with the help of a ray diagram.

Observe Fig. 10.2 (a) closely. A number of rays parallel to the principal axis are falling on a concave mirror. Observe the reflected rays. They are all meeting/intersecting at a point on the principal axis of the mirror. This point is called the principal focus of the concave mirror. Similarly, observe Fig. 10.2 (b). How are the rays parallel to the principal axis, reflected by a convex mirror? The reflected rays appear to come from a point on the principal axis. This point is called the principal focus of the convex mirror. The principal focus is represented by the letter F. The distance between the pole and the principal focus of a spherical mirror is called the focal length. It is represented by the letter f .

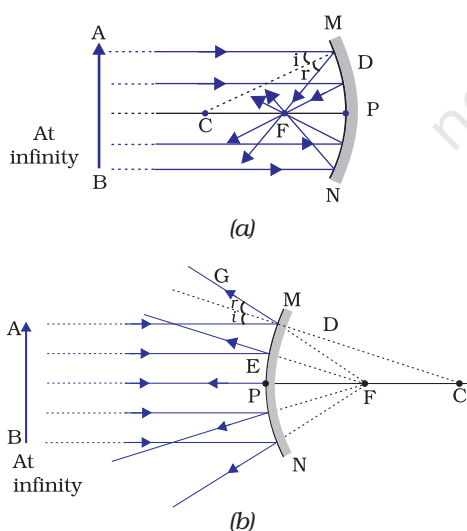

Figure 10.2
(a) Concave mirror
(b) Convex mirror

The reflecting surface of a spherical mirror is by-and-large spherical. The surface, then, has a circular outline. The diameter of the reflecting surface of spherical mirror is called its aperture. In Fig.10.2, distance MN represents the aperture. We shall consider in our discussion only such spherical mirrors whose aperture is much smaller than its radius of curvature.

Is there a relationship between the radius of curvature R , and focal length f , of a spherical mirror? For spherical mirrors of small apertures, the radius of curvature is found to be equal to twice the focal length. We put this as $R = 2f$. This implies that the principal focus of a spherical mirror lies midway between the pole and centre of curvature.

10.2.1 Image Formation by Spherical Mirrors

You have studied about the image formation by plane mirrors. You also know the nature, position and relative size of the images formed by them. How about the images formed by spherical mirrors? How can we locate the image formed by a concave mirror for different positions of the object? Are the images real or virtual? Are they enlarged, diminished or have the same size? We shall explore this with an Activity.

Activity 10.3

You have already learnt a way of determining the focal length of a concave mirror. In Activity 10.2, you have seen that the sharp bright spot of light you got on the paper is, in fact, the image of the Sun. It was a tiny, real, inverted image. You got the approximate focal length of the concave mirror by measuring the distance of the image from the mirror.

- Take a concave mirror. Find out its approximate focal length in the way described above. Note down the value of focal length. (You can also find it out by obtaining image of a distant object on a sheet of paper.)
- Mark a line on a Table with a chalk. Place the concave mirror on a stand. Place the stand over the line such that its pole lies over the line.
- Draw with a chalk two more lines parallel to the previous line such that the distance between any two successive lines is equal to the focal length of the mirror. These lines will now correspond to the positions of the points P, F and C, respectively. *Remember – For a spherical mirror of small aperture, the principal focus F lies mid-way between the pole P and the centre of curvature C.*
- Keep a bright object, say a burning candle, at a position far beyond C. Place a paper screen and move it in front of the mirror till you obtain a sharp bright image of the candle flame on it.
- Observe the image carefully. Note down its nature, position and relative size with respect to the object size.
- Repeat the activity by placing the candle – (a) just beyond C, (b) at C, (c) between F and C, (d) at F, and (e) between P and F.
- In one of the cases, you may not get the image on the screen. Identify the position of the object in such a case. Then, look for its virtual image in the mirror itself.
- Note down and tabulate your observations.

You will see in the above Activity that the nature, position and size of the image formed by a concave mirror depends on the position of the object in relation to points P, F and C. The image formed is real for some positions of the object. It is found to be a virtual image for a certain other position. The image is either magnified, reduced or has the same size, depending on the position of the object. A summary of these observations is given for your reference in Table 10.1.

Table 10.1 Image formation by a concave mirror for different positions of the object

Position of the object	Position of the image	Size of the image	Nature of the image
At infinity	At the focus F	Highly diminished, point-sized	Real and inverted
Beyond C	Between F and C	Diminished	Real and inverted
At C	At C	Same size	Real and inverted
Between C and F	Beyond C	Enlarged	Real and inverted
At F	At infinity	Highly enlarged	Real and inverted
Between P and F	Behind the mirror	Enlarged	Virtual and erect

10.2.2 Representation of Images Formed by Spherical Mirrors Using Ray Diagrams

We can also study the formation of images by spherical mirrors by drawing ray diagrams. Consider an extended object, of finite size, placed in front of a spherical mirror. Each small portion of the extended object acts like a point source. An infinite number of rays originate from each of these points. To construct the ray diagrams, in order to locate the image of an object, an arbitrarily large number of rays emanating from a point could be considered. However, it is more convenient to consider only two rays, for the sake of clarity of the ray diagram. These rays are so chosen that it is easy to know their directions after reflection from the mirror.

The intersection of at least two reflected rays give the position of image of the point object. Any two of the following rays can be considered for locating the image.

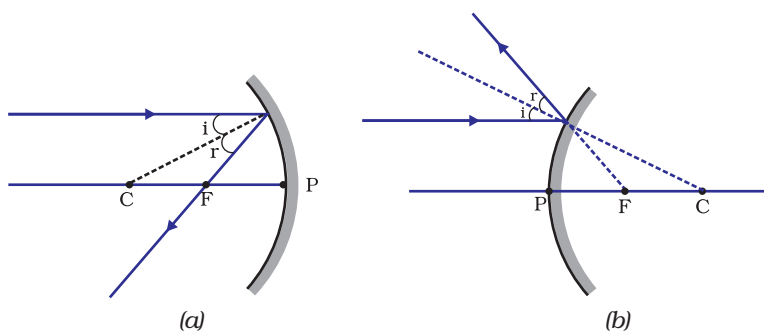

Figure 10.3

- (i) A ray parallel to the principal axis, after reflection, will pass through the principal focus in case of a concave mirror or appear to diverge from the principal focus in case of a convex mirror. This is illustrated in Fig. 10.3 (a) and (b).

- (ii) A ray passing through the principal focus of a concave mirror or a ray which is directed towards the principal focus of a convex mirror, after reflection, will emerge parallel to the principal axis. This is illustrated in Fig.10.4 (a) and (b).

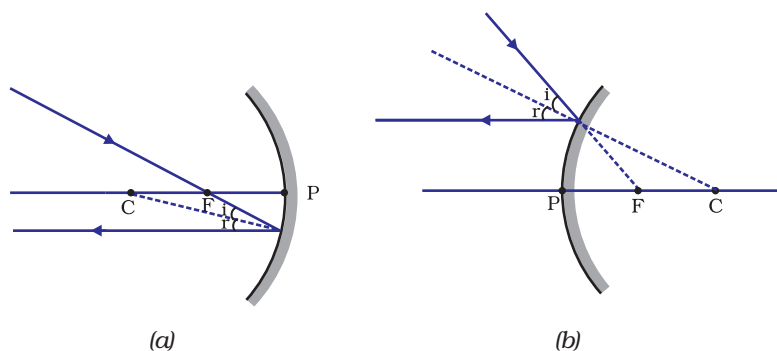

Figure 10.4

- (iii) A ray passing through the centre of curvature of a concave mirror or directed in the direction of the centre of curvature of a convex mirror, after reflection, is reflected back along the same path. This is illustrated in Fig.10.5 (a) and (b). The light rays come back along the same path because the incident rays fall on the mirror along the normal to the reflecting surface.

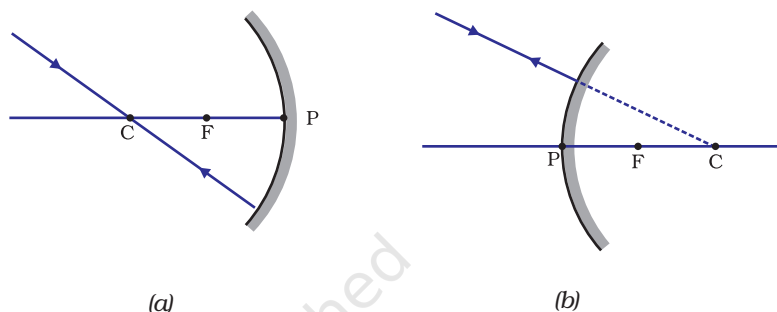

Figure 10.5

- (iv) A ray incident obliquely to the principal axis, towards a point P (pole of the mirror), on the concave mirror [Fig. 10.6 (a)] or a convex mirror [Fig. 10.6 (b)], is reflected obliquely. The incident and reflected rays follow the laws of reflection at the point of incidence (point P), making equal angles with the principal axis.

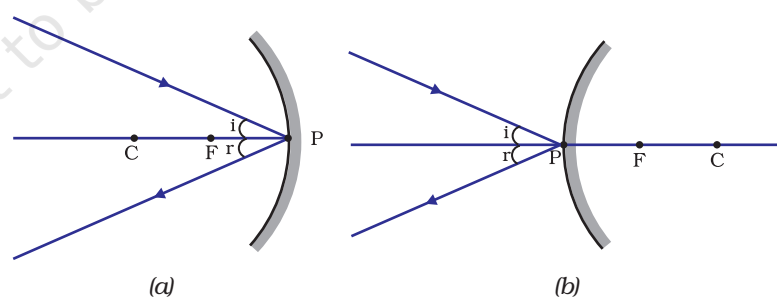

Figure 10.6

Remember that in all the above cases the laws of reflection are followed. At the point of incidence, the incident ray is reflected in such a way that the angle of reflection equals the angle of incidence.

(a) **Image formation by Concave Mirror**

Figure 10.7 illustrates the ray diagrams for the formation of image by a concave mirror for various positions of the object.

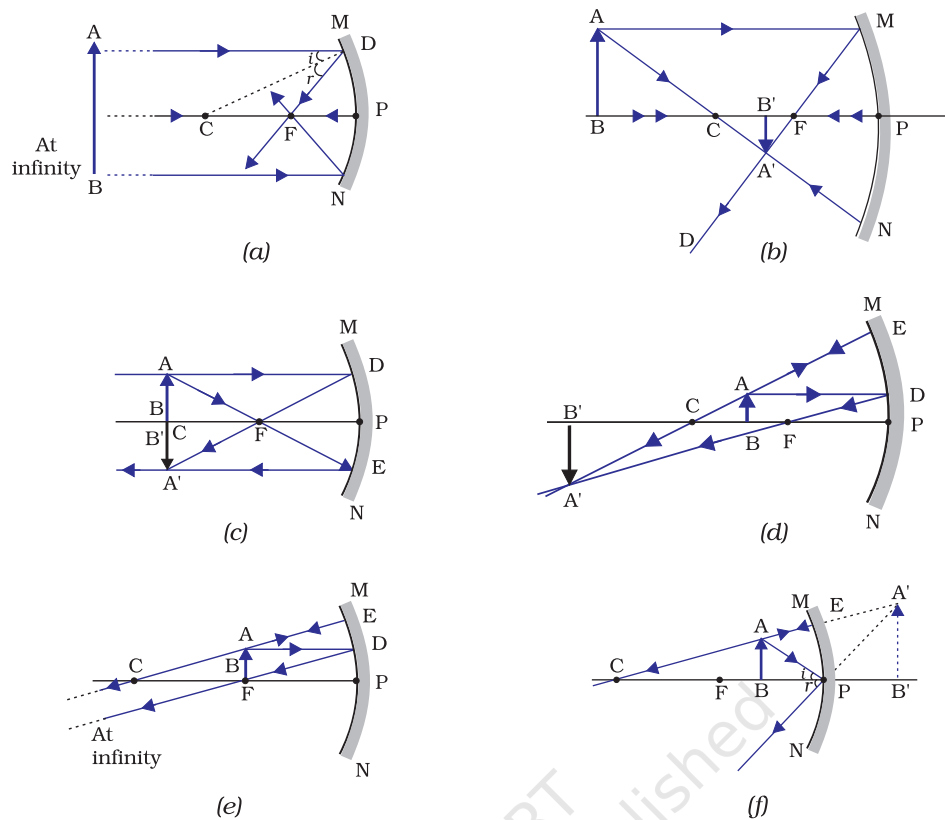

Figure 10.7 Ray diagrams for the image formation by a concave mirror

Activity 10.4

- Draw neat ray diagrams for each position of the object shown in Table 10.1.
- You may take any two of the rays mentioned in the previous section for locating the image.
- Compare your diagram with those given in Fig. 10.7.
- Describe the nature, position and relative size of the image formed in each case.
- Tabulate the results in a convenient format.

Uses of concave mirrors

Concave mirrors are commonly used in torches, search-lights and vehicles headlights to get powerful parallel beams of light. They are often used as shaving mirrors to see a larger image of the face. The dentists use concave mirrors to see large images of the teeth of patients. Large concave mirrors are used to concentrate sunlight to produce heat in solar furnaces.

(b) Image formation by a Convex Mirror

We studied the image formation by a concave mirror. Now we shall study the formation of image by a convex mirror.

Activity 10.5

- Take a convex mirror. Hold it in one hand.
- Hold a pencil in the upright position in the other hand.
- Observe the image of the pencil in the mirror. Is the image erect or inverted? Is it diminished or enlarged?
- Move the pencil away from the mirror slowly. Does the image become smaller or larger?
- Repeat this Activity carefully. State whether the image will move closer to or farther away from the focus as the object is moved away from the mirror?

We consider two positions of the object for studying the image formed by a convex mirror. First is when the object is at infinity and the second position is when the object is at a finite distance from the mirror. The ray diagrams for the formation of image by a convex mirror for these two positions of the object are shown in Fig.10.8 (a) and (b), respectively. The results are summarised in Table 10.2.

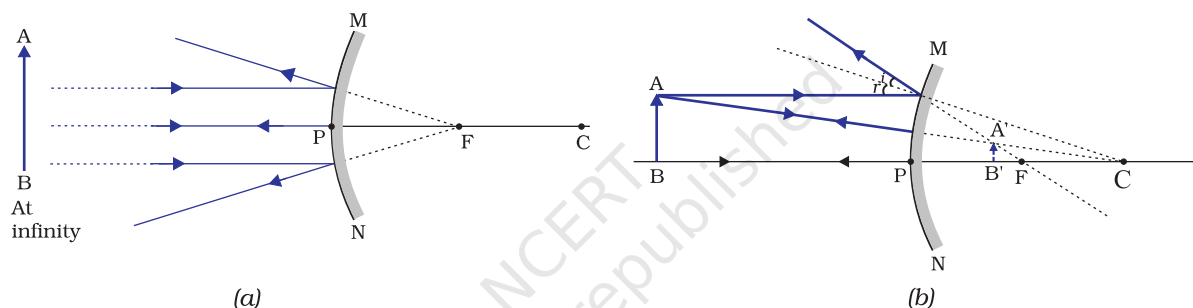

Figure 10.8 Formation of image by a convex mirror

Table 10.2 Nature, position and relative size of the image formed by a convex mirror

Position of the object	Position of the image	Size of the image	Nature of the image
At infinity	At the focus F, behind the mirror	Highly diminished, point-sized	Virtual and erect
Between infinity and the pole P of the mirror	Between P and F, behind the mirror	Diminished	Virtual and erect

You have so far studied the image formation by a plane mirror, a concave mirror and a convex mirror. Which of these mirrors will give the full image of a large object? Let us explore through an Activity.

Activity 10.6

- Observe the image of a distant object, say a distant tree, in a plane mirror.
- Could you see a full-length image?

- Try with plane mirrors of different sizes. Did you see the entire object in the image?
- Repeat this Activity with a concave mirror. Did the mirror show full length image of the object?
- Now try using a convex mirror. Did you succeed? Explain your observations with reason.

You can see a full-length image of a tall building/tree in a small convex mirror. One such mirror is fitted in a wall of Agra Fort facing Taj Mahal. If you visit the Agra Fort, try to observe the full image of Taj Mahal. To view distinctly, you should stand suitably at the terrace adjoining the wall.

Uses of convex mirrors

Convex mirrors are commonly used as rear-view (wing) mirrors in vehicles. These mirrors are fitted on the sides of the vehicle, enabling the driver to see traffic behind him/her to facilitate safe driving. Convex mirrors are preferred because they always give an erect, though diminished, image. Also, they have a wider field of view as they are curved outwards. Thus, convex mirrors enable the driver to view much larger area than would be possible with a plane mirror.

Q U E S T I O N S

1. Define the principal focus of a concave mirror.
2. The radius of curvature of a spherical mirror is 20 cm. What is its focal length?
3. Name a mirror that can give an erect and enlarged image of an object.
4. Why do we prefer a convex mirror as a rear-view mirror in vehicles?



10.2.3 Sign Convention for Reflection by Spherical Mirrors

While dealing with the reflection of light by spherical mirrors, we shall follow a set of sign conventions called the *New Cartesian Sign Convention*. In this convention, the pole (P) of the mirror is taken as the origin (Fig. 10.9). The principal axis of the mirror is taken as the x-axis (XX') of the coordinate system. The conventions are as follows –

- (i) The object is always placed to the left of the mirror. This implies that the light from the object falls on the mirror from the left-hand side.
- (ii) All distances parallel to the principal axis are measured from the pole of the mirror.
- (iii) All the distances measured to the right of the origin (along + x-axis) are taken as positive while those measured to the left of the origin (along – x-axis) are taken as negative.
- (iv) Distances measured perpendicular to and above the principal axis (along + y-axis) are taken as positive.
- (v) Distances measured perpendicular to and below the principal axis (along –y-axis) are taken as negative.

The New Cartesian Sign Convention described above is illustrated in Fig. 10.9 for your reference. These sign conventions are applied to obtain the mirror formula and solve related numerical problems.

10.2.4 Mirror Formula and Magnification

In a spherical mirror, the distance of the object from its pole is called the object distance (u). The distance of the image from the pole of the mirror is called the image distance (v). You already know that the distance of the principal focus from the pole is called the focal length (f). There is a relationship between these three quantities given by the *mirror formula* which is expressed as

$$\frac{1}{v} + \frac{1}{u} = \frac{1}{f} \quad (10.1)$$

This formula is valid in all situations for all spherical mirrors for all positions of the object. You must use the New Cartesian Sign Convention while substituting numerical values for u , v , f , and R in the mirror formula for solving problems.

Magnification

Magnification produced by a spherical mirror gives the relative extent to which the image of an object is magnified with respect to the object size. It is expressed as the ratio of the height of the image to the height of the object. It is usually represented by the letter m .

If h is the height of the object and h' is the height of the image, then the magnification m produced by a spherical mirror is given by

$$m = \frac{\text{Height of the image } (h')}{\text{Height of the object } (h)}$$

$$m = \frac{h'}{h} \quad (10.2)$$

The magnification m is also related to the object distance (u) and image distance (v). It can be expressed as:

$$\text{Magnification } (m) = \frac{h'}{h} = -\frac{v}{u} \quad (10.3)$$

You may note that the height of the object is taken to be positive as the object is usually placed above the principal axis. The height of the image should be taken as positive for virtual images. However, it is to be taken as negative for real images. A negative sign in the value of the magnification indicates that the image is real. A positive sign in the value of the magnification indicates that the image is virtual.

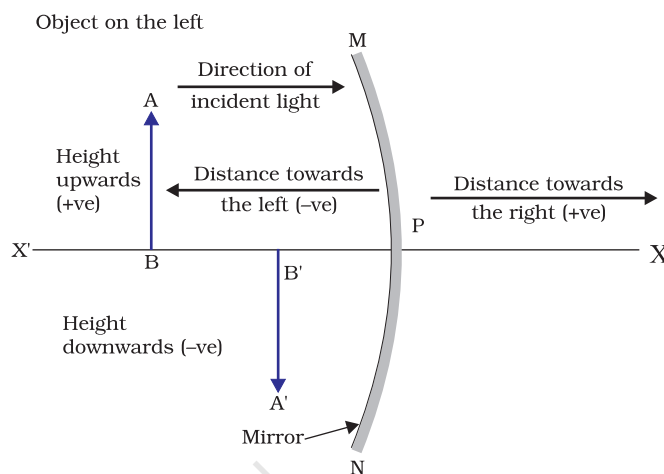

Figure 10.9
The New Cartesian Sign Convention for spherical mirrors

Example 10.1

A convex mirror used for rear-view on an automobile has a radius of curvature of 3.00 m. If a bus is located at 5.00 m from this mirror, find the position, nature and size of the image.

Solution

Radius of curvature, $R = + 3.00$ m;

Object-distance, $u = - 5.00$ m;

Image-distance, $v = ?$

Height of the image, $h' = ?$

Focal length, $f = R/2 = + \frac{3.00 \text{ m}}{2} = + 1.50$ m (as the principal focus of a convex mirror is behind the mirror)

$$\text{Since } \frac{1}{v} + \frac{1}{u} = \frac{1}{f}$$

$$\text{or, } \frac{1}{v} = \frac{1}{f} - \frac{1}{u} = + \frac{1}{1.50} - \frac{1}{(-5.00)} = \frac{1}{1.50} + \frac{1}{5.00}$$
$$= \frac{5.00 + 1.50}{7.50}$$

$$v = \frac{+7.50}{6.50} = + 1.15 \text{ m}$$

The image is 1.15 m at the back of the mirror.

$$\text{Magnification, } m = \frac{h'}{h} = - \frac{v}{u} = - \frac{1.15 \text{ m}}{-5.00 \text{ m}}$$
$$= + 0.23$$

The image is virtual, erect and smaller in size by a factor of 0.23.

Example 10.2

An object, 4.0 cm in size, is placed at 25.0 cm in front of a concave mirror of focal length 15.0 cm. At what distance from the mirror should a screen be placed in order to obtain a sharp image? Find the nature and the size of the image.

Solution

Object-size, $h = + 4.0$ cm;

Object-distance, $u = - 25.0$ cm;

Focal length, $f = - 15.0$ cm;

Image-distance, $v = ?$

Image-size, $h' = ?$

From Eq. (10.1):

$$\frac{1}{v} + \frac{1}{u} = \frac{1}{f}$$

$$\text{or, } \frac{1}{v} = \frac{1}{f} - \frac{1}{u} = \frac{1}{-15.0} - \frac{1}{-25.0} = - \frac{1}{15.0} + \frac{1}{25.0}$$

$$\text{or, } \frac{1}{v} = \frac{-5.0 + 3.0}{75.0} = \frac{-2.0}{75.0} \quad \text{or, } v = -37.5 \text{ cm}$$

The screen should be placed at 37.5 cm in front of the mirror. The image is real.

$$\text{Also, magnification, } m = \frac{h'}{h} = -\frac{v}{u}$$

$$\text{or, } h' = -\frac{vh}{u} = -\frac{(-37.5 \text{ cm})(+4.0 \text{ cm})}{(-25.0 \text{ cm})}$$

Height of the image, $h' = -6.0 \text{ cm}$
The image is inverted and enlarged.

Q U E S T I O N S

1. Find the focal length of a convex mirror whose radius of curvature is 32 cm.
2. A concave mirror produces three times magnified (enlarged) real image of an object placed at 10 cm in front of it. Where is the image located?



10.3 REFRACTION OF LIGHT

Light seems to travel along straight-line paths in a transparent medium. What happens when light enters from one transparent medium to another? Does it still move along a straight-line path or change its direction? We shall recall some of our day-to-day experiences.

You might have observed that the bottom of a tank or a pond containing water appears to be raised. Similarly, when a thick glass slab is placed over some printed matter, the letters appear raised when viewed through the glass slab. Why does it happen? Have you seen a pencil partly immersed in water in a glass tumbler? It appears to be displaced at the interface of air and water. You might have observed that a lemon kept in water in a glass tumbler appears to be bigger than its actual size, when viewed from the sides. How can you account for such experiences?

Let us consider the case of the apparent displacement of a pencil, partly immersed in water. The light reaching you from the portion of the pencil inside water seems to come from a different direction, compared to the part above water. This makes the pencil appear to be displaced at the interface. For similar reasons, the letters appear to be raised, when seen through a glass slab placed over it.

Does a pencil appear to be displaced to the same extent, if instead of water, we use liquids like kerosene or turpentine? Will the letters appear to rise to the same height if we replace a glass slab with a transparent plastic slab? You will find that the extent of the effect is different for different pair of media. These observations indicate that light does not

travel in the same direction in all media. It appears that when travelling obliquely from one medium to another, the direction of propagation of light in the second medium changes. This phenomenon is known as refraction of light. Let us understand this phenomenon further by doing a few activities.

Activity 10.7

- Place a coin at the bottom of a bucket filled with water.
- With your eye to a side above water, try to pick up the coin in one go. Did you succeed in picking up the coin?
- Repeat the Activity. Why did you not succeed in doing it in one go?
- Ask your friends to do this. Compare your experience with theirs.

Activity 10.8

- Place a large shallow bowl on a Table and put a coin in it.
- Move away slowly from the bowl. Stop when the coin just disappears from your sight.
- Ask a friend to pour water gently into the bowl without disturbing the coin.
- Keep looking for the coin from your position. Does the coin becomes visible again from your position? How could this happen?

The coin becomes visible again on pouring water into the bowl. The coin appears slightly raised above its actual position due to refraction of light.

Activity 10.9

- Draw a thick straight line in ink, over a sheet of white paper placed on a Table.
- Place a glass slab over the line in such a way that one of its edges makes an angle with the line.
- Look at the portion of the line under the slab from the sides. What do you observe? Does the line under the glass slab appear to be bent at the edges?
- Next, place the glass slab such that it is normal to the line. What do you observe now? Does the part of the line under the glass slab appear bent?
- Look at the line from the top of the glass slab. Does the part of the line, beneath the slab, appear to be raised? Why does this happen?

10.3.1 Refraction through a Rectangular Glass Slab

To understand the phenomenon of refraction of light through a glass slab, let us do an Activity.

Activity 10.10

- Fix a sheet of white paper on a drawing board using drawing pins.
- Place a rectangular glass slab over the sheet in the middle.
- Draw the outline of the slab with a pencil. Let us name the outline as ABCD.
- Take four identical pins.
- Fix two pins, say E and F, vertically such that the line joining the pins is inclined to the edge AB.
- Look for the images of the pins E and F through the opposite edge. Fix two other pins, say G and H, such that these pins and the images of E and F lie on a straight line.
- Remove the pins and the slab.
- Join the positions of tip of the pins E and F and produce the line up to AB. Let EF meet AB at O. Similarly, join the positions of tip of the pins G and H and produce it up to the edge CD. Let HG meet CD at O'.
- Join O and O'. Also produce EF up to P, as shown by a dotted line in Fig. 10.10.

In this Activity, you will note, the light ray has changed its direction at points O and O'. Note that both the points O and O' lie on surfaces separating two transparent media. Draw a perpendicular NN' to AB at O and another perpendicular MM' to CD at O'. The light ray at point O has entered from a rarer medium to a denser medium, that is, from air to glass. Note that the light ray has bent towards the normal. At O', the light ray has entered from glass to air, that is, from a denser medium to a rarer medium. The light here has bent away from the normal. Compare the angle of incidence with the angle of refraction at both refracting surfaces AB and CD.

In Fig. 10.10, a ray EO is obliquely incident on surface AB, called incident ray. OO' is the refracted ray and O'H is the emergent ray. You may observe that the emergent ray is parallel to the direction of the incident ray. Why does it happen so? The extent of bending of the ray of light at the opposite parallel faces AB (air-glass interface) and CD (glass-air interface) of the rectangular glass slab is equal and opposite. This is why the ray emerges parallel to the incident ray. However, the light ray is shifted sideward slightly. What happens when a light ray is incident normally to the interface of two media? Try and find out.

Now you are familiar with the refraction of light. Refraction is due to change in the speed of light as it enters from one transparent medium to another. Experiments show that refraction of light occurs according to certain laws.

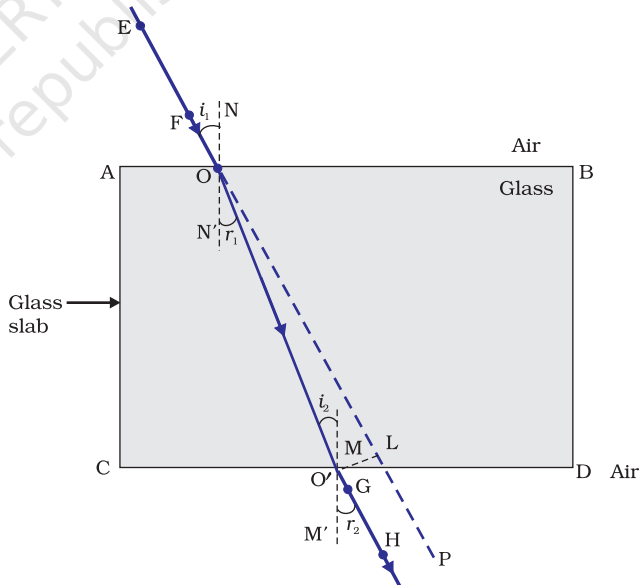

Figure 10.10
Refraction of light through a rectangular glass slab

The following are the *laws of refraction of light*.

- (i) *The incident ray, the refracted ray and the normal to the interface of two transparent media at the point of incidence, all lie in the same plane.*
- (ii) *The ratio of sine of angle of incidence to the sine of angle of refraction is a constant, for the light of a given colour and for the given pair of media.* This law is also known as Snell's law of refraction. (This is true for angle $0 < i < 90^\circ$)

If i is the angle of incidence and r is the angle of refraction, then,

$$\frac{\sin i}{\sin r} = \text{constant} \quad (10.4)$$

This constant value is called the refractive index of the second medium with respect to the first. Let us study about refractive index in some detail.

10.3.2 The Refractive Index

You have already studied that a ray of light that travels obliquely from one transparent medium into another will change its direction in the second medium. The extent of the change in direction that takes place in a given pair of media may be expressed in terms of the refractive index, the "constant" appearing on the right-hand side of Eq.(10.4).

The refractive index can be linked to an important physical quantity, the relative speed of propagation of light in different media. It turns out that light propagates with different speeds in different media. Light travels fastest in vacuum with speed of $3 \times 10^8 \text{ m s}^{-1}$. In air, the speed of light is only marginally less, compared to that in vacuum. It reduces considerably in glass or water. The value of the refractive index for a given pair of media depends upon the speed of light in the two media, as given below.

Consider a ray of light travelling from medium 1 into medium 2, as shown in Fig. 10.11. Let v_1 be the speed of light in medium 1 and v_2 be the speed of light in medium 2. The refractive index of medium 2 with respect to medium 1 is given by the ratio of the speed of light in medium 1 and the speed of light in medium 2. This is usually represented by the symbol n_{21} . This can be expressed in an equation form as

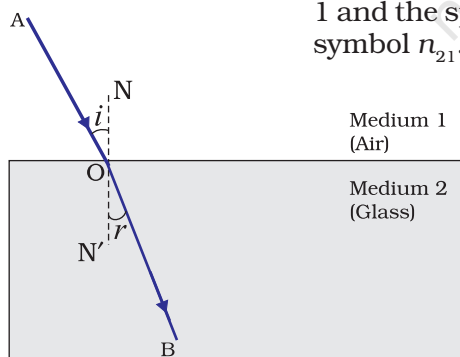

Figure 10.11

$$n_{21} = \frac{\text{Speed of light in medium 1}}{\text{Speed of light in medium 2}} = \frac{v_1}{v_2} \quad (10.5)$$

By the same argument, the refractive index of medium 1 with respect to medium 2 is represented as n_{12} . It is given by

$$n_{12} = \frac{\text{Speed of light in medium 2}}{\text{Speed of light in medium 1}} = \frac{v_2}{v_1} \quad (10.6)$$

If medium 1 is vacuum or air, then the refractive index of medium 2 is considered with respect to vacuum. This is called the absolute refractive index of the medium. It is simply represented as n_2 . If c is the speed of

light in air and v is the speed of light in the medium, then, the refractive index of the medium n_m is given by

$$n_m = \frac{\text{Speed of light in air}}{\text{Speed of light in the medium}} = \frac{c}{v} \quad (10.7)$$

The absolute refractive index of a medium is simply called its refractive index. The refractive index of several media is given in Table 10.3. From the Table you can know that the refractive index of water, $n_w = 1.33$. This means that the ratio of the speed of light in air and the speed of light in water is equal to 1.33. Similarly, the refractive index of crown glass, $n_g = 1.52$. Such data are helpful in many places. However, you need not memorise the data.

Table 10.3 Absolute refractive index of some material media

Material medium	Refractive index	Material medium	Refractive index
Air	1.0003	Canada Balsam	1.53
Ice	1.31	Rock salt	1.54
Water	1.33	Carbon disulphide	1.63
Alcohol	1.36	Dense flint glass	1.65
Kerosene	1.44	Ruby	1.71
Fused quartz	1.46	Sapphire	1.77
Turpentine oil	1.47	Diamond	2.42
Benzene	1.50		
Crown glass	1.52		

Note from Table 10.3 that an optically denser medium may not possess greater mass density. For example, kerosene having higher refractive index, is optically denser than water, although its mass density is less than water.

More to Know!

The ability of a medium to refract light is also expressed in terms of its optical density. Optical density has a definite connotation. It is not the same as mass density. We have been using the terms 'rarer medium' and 'denser medium' in this Chapter. It actually means 'optically rarer medium' and 'optically denser medium', respectively. When can we say that a medium is optically denser than the other? In comparing two media, the one with the larger refractive index is optically denser medium than the other. The other medium of lower refractive index is optically rarer. The speed of light is higher in a rarer medium than a denser medium. Thus, a ray of light travelling from a rarer medium to a denser medium slows down and bends towards the normal. When it travels from a denser medium to a rarer medium, it speeds up and bends away from the normal.

Q U E S T I O N S

1. A ray of light travelling in air enters obliquely into water. Does the light ray bend towards the normal or away from the normal? Why?
2. Light enters from air to glass having refractive index 1.50. What is the speed of light in the glass? The speed of light in vacuum is $3 \times 10^8 \text{ m s}^{-1}$.
3. Find out, from Table 10.3, the medium having highest optical density. Also find the medium with lowest optical density.
4. You are given kerosene, turpentine and water. In which of these does the light travel fastest? Use the information given in Table 10.3.
5. The refractive index of diamond is 2.42. What is the meaning of this statement?



10.3.3 Refraction by Spherical Lenses

You might have seen watchmakers using a small magnifying glass to see tiny parts. Have you ever touched the surface of a magnifying glass with your hand? Is it plane surface or curved? Is it thicker in the middle or at the edges? The glasses used in spectacles and that by a watchmaker are examples of lenses. What is a lens? How does it bend light rays? We shall discuss these in this section.

A transparent material bound by two surfaces, of which one or both

surfaces are spherical, forms a lens. This means that a lens is bound by at least one spherical surface. In such lenses, the other surface would be plane. A lens may have two spherical surfaces, bulging outwards. Such a lens is called a double convex lens. It is simply called a convex lens. It is thicker at the middle as compared to the edges. Convex lens converges light rays as shown in Fig. 10.12 (a). Hence convex lenses are also called converging lenses. Similarly, a double concave lens is bounded by two spherical surfaces, curved inwards. It is thicker at the edges than at the middle. Such lenses diverge light rays as shown in Fig. 10.12 (b). Such lenses are also called diverging lenses. A double concave lens is simply called a concave lens.

A lens, either a convex lens or a concave lens, has two spherical surfaces. Each of these surfaces forms a part of a sphere. The centres of these spheres are called centres of curvature of the lens. The centre of curvature of a lens is usually represented by the letter C. Since there are two

centres of curvature, we may represent them as C_1 and C_2 . An imaginary straight line passing through the two centres of curvature of a lens is called its principal axis. The central point of a lens is its optical centre. It is

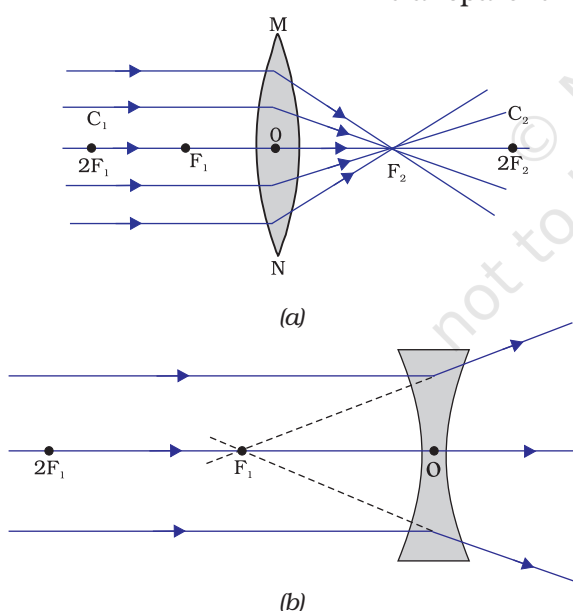

Figure 10.12

(a) Converging action of a convex lens, (b) diverging action of a concave lens

usually represented by the letter O. A ray of light through the optical centre of a lens passes without suffering any deviation. The effective diameter of the circular outline of a spherical lens is called its aperture. We shall confine our discussion in this Chapter to such lenses whose aperture is much less than its radius of curvature and the two centres of curvatures are equidistant from the optical centre O. Such lenses are called thin lenses with small apertures. What happens when parallel rays of light are incident on a lens? Let us do an Activity to understand this.

Activity 10.11

CAUTION: Do not look at the Sun directly or through a lens while doing this Activity or otherwise. You may damage your eyes if you do so.

- Hold a convex lens in your hand. Direct it towards the Sun.
- Focus the light from the Sun on a sheet of paper. Obtain a sharp bright image of the Sun.
- Hold the paper and the lens in the same position for a while. Keep observing the paper. What happened? Why? Recall your experience in Activity 10.2.

The paper begins to burn producing smoke. It may even catch fire after a while. Why does this happen? The light from the Sun constitutes parallel rays of light. These rays were converged by the lens at the sharp bright spot formed on the paper. In fact, the bright spot you got on the paper is a real image of the Sun. The concentration of the sunlight at a point generated heat. This caused the paper to burn.

Now, we shall consider rays of light parallel to the principal axis of a lens. What happens when you pass such rays of light through a lens? This is illustrated for a convex lens in Fig.10.12 (a) and for a concave lens in Fig.10.12 (b).

Observe Fig.10.12 (a) carefully. Several rays of light parallel to the principal axis are falling on a convex lens. These rays, after refraction from the lens, are converging to a point on the principal axis. This point on the principal axis is called the principal focus of the lens. Let us see now the action of a concave lens.

Observe Fig.10.12 (b) carefully. Several rays of light parallel to the principal axis are falling on a concave lens. These rays, after refraction from the lens, are appearing to diverge from a point on the principal axis. This point on the principal axis is called the principal focus of the concave lens.

If you pass parallel rays from the opposite surface of the lens, you get another principal focus on the opposite side. Letter F is usually used to represent principal focus. However, a lens has two principal foci. They are represented by F_1 and F_2 . The distance of the principal focus from the optical centre of a lens is called its focal length. The letter f is used to represent the focal length. How can you find the focal length of a convex lens? Recall the Activity 10.11. In this Activity, the distance between the position of the lens and the position of the image of the Sun gives the approximate focal length of the lens.

10.3.4 Image Formation by Lenses

Lenses form images by refracting light. How do lenses form images? What is their nature? Let us study this for a convex lens first.

Activity 10.12

- Take a convex lens. Find its approximate focal length in a way described in Activity 10.11.
- Draw five parallel straight lines, using chalk, on a long Table such that the distance between the successive lines is equal to the focal length of the lens.
- Place the lens on a lens stand. Place it on the central line such that the optical centre of the lens lies just over the line.
- The two lines on either side of the lens correspond to F and $2F$ of the lens respectively. Mark them with appropriate letters such as $2F_1$, F_1 , F_2 and $2F_2$, respectively.
- Place a burning candle, far beyond $2F_1$ to the left. Obtain a clear sharp image on a screen on the opposite side of the lens.
- Note down the nature, position and relative size of the image.
- Repeat this Activity by placing object just behind $2F_1$, between F_1 and $2F_1$ at F_1 , between F_1 and O . Note down and tabulate your observations.

The nature, position and relative size of the image formed by convex lens for various positions of the object is summarised in Table 10.4.

Table 10.4 Nature, position and relative size of the image formed by a convex lens for various positions of the object

Position of the object	Position of the image	Relative size of the image	Nature of the image
At infinity	At focus F_2	Highly diminished, point-sized	Real and inverted
Beyond $2F_1$	Between F_2 and $2F_2$	Diminished	Real and inverted
At $2F_1$	At $2F_2$	Same size	Real and inverted
Between F_1 and $2F_1$	Beyond $2F_2$	Enlarged	Real and inverted
At focus F_1	At infinity	Infinitely large or highly enlarged	Real and inverted
Between focus F_1 and optical centre O	On the same side of the lens as the object	Enlarged	Virtual and erect

Let us now do an Activity to study the nature, position and relative size of the image formed by a concave lens.

Activity 10.13

- Take a concave lens. Place it on a lens stand.
- Place a burning candle on one side of the lens.
- Look through the lens from the other side and observe the image. Try to get the image on a screen, if possible. If not, observe the image directly through the lens.
- Note down the nature, relative size and approximate position of the image.
- Move the candle away from the lens. Note the change in the size of the image. What happens to the size of the image when the candle is placed too far away from the lens.

The summary of the above Activity is given in Table 10.5 below.

Table 10.5 Nature, position and relative size of the image formed by a concave lens for various positions of the object

Position of the object	Position of the image	Relative size of the image	Nature of the image
At infinity	At focus F_1	Highly diminished, point-sized	Virtual and erect
Between infinity and optical centre O of the lens	Between focus F_1 and optical centre O	Diminished	Virtual and erect

What conclusion can you draw from this Activity? A concave lens will always give a virtual, erect and diminished image, irrespective of the position of the object.

10.3.5 Image Formation in Lenses Using Ray Diagrams

We can represent image formation by lenses using ray diagrams. Ray diagrams will also help us to study the nature, position and relative size of the image formed by lenses. For drawing ray diagrams in lenses, alike of spherical mirrors, we consider any two of the following rays –

- (i) A ray of light from the object, parallel to the principal axis, after refraction from a convex lens, passes through the principal focus on the other side of the lens, as shown in Fig. 10.13 (a). In case of a concave lens, the ray appears to diverge from the principal focus located on the same side of the lens, as shown in Fig. 10.13 (b).

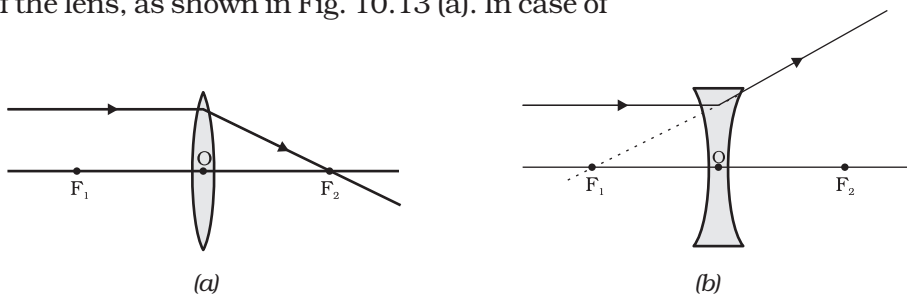

Figure 10.13

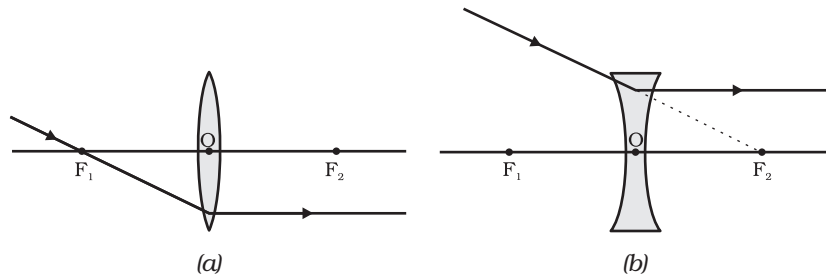

Figure 10.14

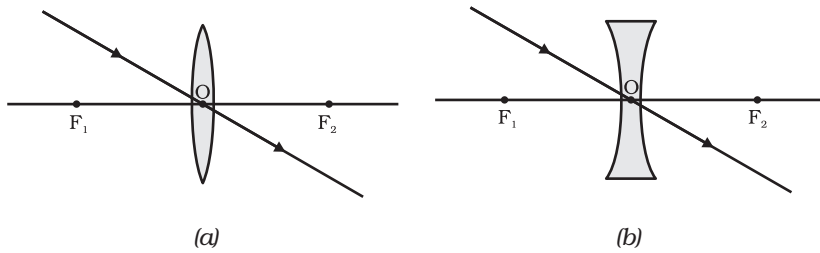
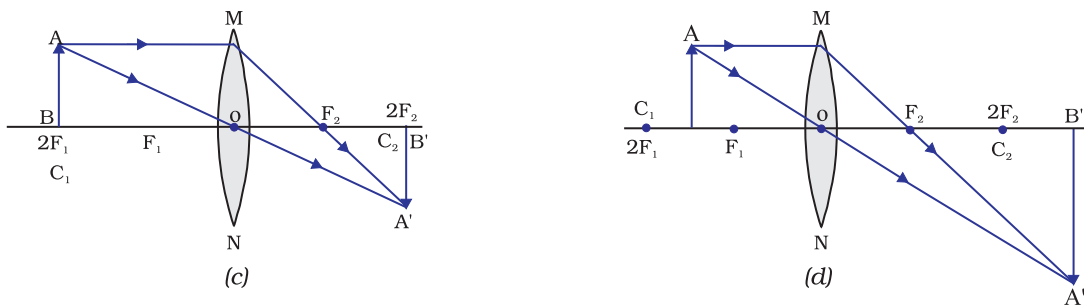
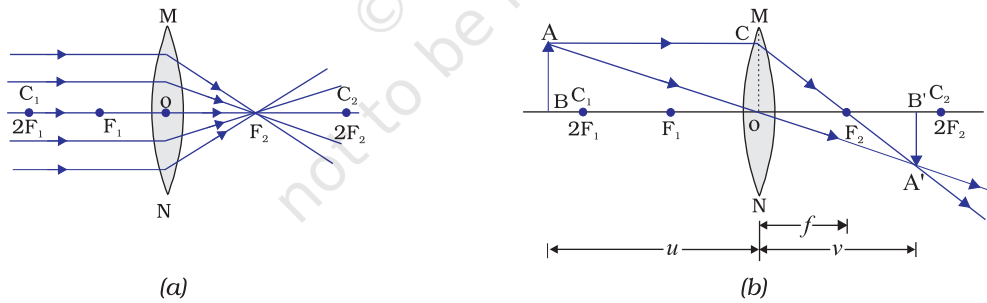

Figure 10.15

- (ii) A ray of light passing through a principal focus, after refraction from a convex lens, will emerge parallel to the principal axis. This is shown in Fig. 10.14 (a). A ray of light appearing to meet at the principal focus of a concave lens, after refraction, will emerge parallel to the principal axis. This is shown in Fig. 10.14 (b).
- (iii) A ray of light passing through the optical centre of a lens will emerge without any deviation. This is illustrated in Fig. 10.15 (a) and Fig. 10.15 (b).

The ray diagrams for the image formation in a convex lens for a few positions of the object are shown in Fig. 10.16. The ray diagrams representing the image formation in a concave lens for various positions of the object are shown in Fig. 10.17.



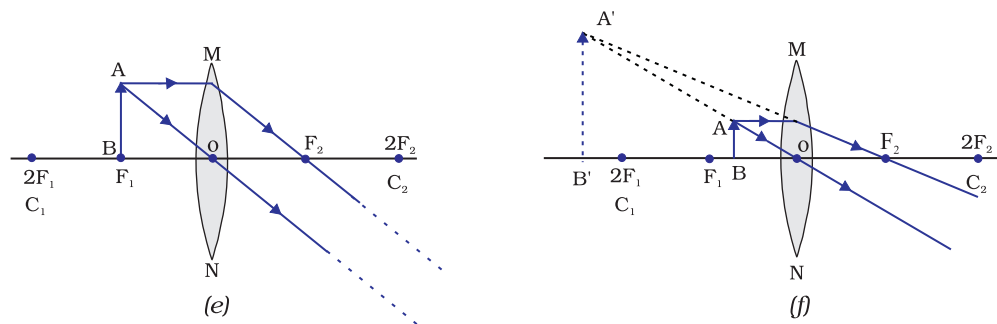

Figure 10.16 The position, size and the nature of the image formed by a convex lens for various positions of the object

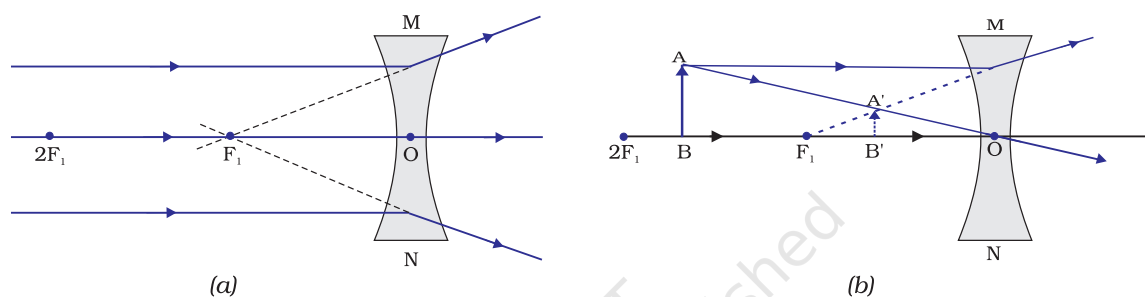

Figure 10.17 Nature, position and relative size of the image formed by a concave lens

10.3.6 Sign Convention for Spherical Lenses

For lenses, we follow sign convention, similar to the one used for spherical mirrors. We apply the rules for signs of distances, except that all measurements are taken from the optical centre of the lens. According to the convention, the focal length of a convex lens is positive and that of a concave lens is negative. You must take care to apply appropriate signs for the values of u , v , f , object height h and image height h' .

10.3.7 Lens Formula and Magnification

As we have a formula for spherical mirrors, we also have formula for spherical lenses. This formula gives the relationship between object-distance (u), image-distance (v) and the focal length (f). The lens formula is expressed as

$$\frac{1}{v} - \frac{1}{u} = \frac{1}{f} \quad (10.8)$$

The lens formula given above is general and is valid in all situations for any spherical lens. Take proper care of the signs of different quantities, while putting numerical values for solving problems relating to lenses.

Magnification

The magnification produced by a lens, similar to that for spherical mirrors, is defined as the ratio of the height of the image and the height of the object. Magnification is represented by the letter m . If h is the height of the object and h' is the height of the image given by a lens, then the magnification produced by the lens is given by,

$$m = \frac{\text{Height of the Image}}{\text{Height of the object}} = \frac{h'}{h} \quad (10.9)$$

Magnification produced by a lens is also related to the object-distance u , and the image-distance v . This relationship is given by

$$\text{Magnification } (m) = h'/h = v/u \quad (10.10)$$

Example 10.3

A concave lens has focal length of 15 cm. At what distance should the object from the lens be placed so that it forms an image at 10 cm from the lens? Also, find the magnification produced by the lens.

Solution

A concave lens always forms a virtual, erect image on the same side of the object.

$$\text{Image-distance } v = -10 \text{ cm;}$$

$$\text{Focal length } f = -15 \text{ cm;}$$

$$\text{Object-distance } u = ?$$

$$\text{Since } \frac{1}{v} - \frac{1}{u} = \frac{1}{f}$$

$$\text{or, } \frac{1}{u} = \frac{1}{v} - \frac{1}{f}$$

$$\frac{1}{u} = \frac{1}{-10} - \frac{1}{(-15)} = -\frac{1}{10} + \frac{1}{15}$$

$$\frac{1}{u} = \frac{-3 + 2}{30} = \frac{1}{-30}$$

$$\text{or, } u = -30 \text{ cm}$$

Thus, the object-distance is 30 cm.

$$\text{Magnification } m = v/u$$

$$m = \frac{-10 \text{ cm}}{-30 \text{ cm}} = \frac{1}{3} \approx +0.33$$

The positive sign shows that the image is erect and virtual. The image is one-third of the size of the object.

Example 10.4

A 2.0 cm tall object is placed perpendicular to the principal axis of a convex lens of focal length 10 cm. The distance of the object from the lens is 15 cm. Find the nature, position and size of the image. Also find its magnification.

Solution

Height of the object $h = +2.0$ cm;

Focal length $f = +10$ cm;

object-distance $u = -15$ cm;

Image-distance $v = ?$

Height of the image $h' = ?$

$$\text{Since } \frac{1}{v} - \frac{1}{u} = \frac{1}{f}$$

$$\text{or, } \frac{1}{v} = \frac{1}{u} + \frac{1}{f}$$

$$\frac{1}{v} = \frac{1}{(-15)} + \frac{1}{10} = -\frac{1}{15} + \frac{1}{10}$$

$$\frac{1}{v} = \frac{-2 + 3}{30} = \frac{1}{30}$$

$$\text{or, } v = +30 \text{ cm}$$

The positive sign of v shows that the image is formed at a distance of 30 cm on the other side of the optical centre. The image is real and inverted.

$$\text{Magnification } m = \frac{h'}{h} = \frac{v}{u}$$

$$\text{or, } h' = h(v/u)$$

Height of the image, $h' = (2.0)(+30/-15) = -4.0$ cm

Magnification $m = v/u$

$$\text{or, } m = \frac{+30 \text{ cm}}{-15 \text{ cm}} = -2$$

The negative signs of m and h' show that the image is inverted and real. It is formed below the principal axis. Thus, a real, inverted image, 4 cm tall, is formed at a distance of 30 cm on the other side of the lens. The image is two times enlarged.

10.3.8 Power of a Lens

You have already learnt that the ability of a lens to converge or diverge light rays depends on its focal length. For example, a convex lens of short focal length bends the light rays through large angles, by focussing them closer to the optical centre. Similarly, concave lens of very short focal length causes higher divergence than the one with longer focal length. The degree of convergence or divergence of light rays achieved by a lens is expressed in terms of its power. The power of a lens is defined as the reciprocal of its focal length. It is represented by the letter P . The power P of a lens of focal length f is given by

$$P = \frac{1}{f} \quad (10.11)$$

The SI unit of power of a lens is 'diopetre'. It is denoted by the letter D. If f is expressed in metres, then, power is expressed in diopetres. Thus, 1 diopetre is the power of a lens whose focal length is 1 metre. $1\text{D} = 1\text{m}^{-1}$. You may note that the *power of a convex lens is positive and that of a concave lens is negative*.

Opticians prescribe corrective lenses indicating their powers. Let us say the lens prescribed has power equal to + 2.0 D. This means the lens prescribed is convex. The focal length of the lens is + 0.50 m. Similarly, a lens of power – 2.5 D has a focal length of – 0.40 m. The lens is concave.

More to Know!

Many optical instruments consist of a number of lenses. They are combined to increase the magnification and sharpness of the image. The net power (P) of the lenses placed in contact is given by the algebraic sum of the individual powers P_1, P_2, P_3, \dots as $P = P_1 + P_2 + P_3 + \dots$

The use of powers, instead of focal lengths, for lenses is quite convenient for opticians. During eye-testing, an optician puts several different combinations of corrective lenses of known power, in contact, inside the testing spectacles' frame. The optician calculates the power of the lens required by simple algebraic addition. For example, a combination of two lenses of power + 2.0 D and + 0.25 D is equivalent to a single lens of power + 2.25 D. The simple additive property of the powers of lenses can be used to design lens systems to minimise certain defects in images produced by a single lens. Such a lens system, consisting of several lenses, in contact, is commonly used in the design of lenses of camera, microscopes and telescopes.

Q U E S T I O N S

1. Define 1 diopetre of power of a lens.
2. A convex lens forms a real and inverted image of a needle at a distance of 50 cm from it. Where is the needle placed in front of the convex lens if the image is equal to the size of the object? Also, find the power of the lens.
3. Find the power of a concave lens of focal length 2 m.



What you have learnt

- Light seems to travel in straight lines.
- Mirrors and lenses form images of objects. Images can be either real or virtual, depending on the position of the object.
- The reflecting surfaces, of all types, obey the laws of reflection. The refracting surfaces obey the laws of refraction.
- New Cartesian Sign Conventions are followed for spherical mirrors and lenses.

- Mirror formula, $\frac{1}{v} + \frac{1}{u} = \frac{1}{f}$, gives the relationship between the object-distance (u), image-distance (v), and focal length (f) of a spherical mirror.
- The focal length of a spherical mirror is equal to half its radius of curvature.
- The magnification produced by a spherical mirror is the ratio of the height of the image to the height of the object.
- A light ray travelling obliquely from a denser medium to a rarer medium bends away from the normal. A light ray bends towards the normal when it travels obliquely from a rarer to a denser medium.
- Light travels in vacuum with an enormous speed of $3 \times 10^8 \text{ m s}^{-1}$. The speed of light is different in different media.
- The refractive index of a transparent medium is the ratio of the speed of light in vacuum to that in the medium.
- In case of a rectangular glass slab, the refraction takes place at both air-glass interface and glass-air interface. The emergent ray is parallel to the direction of incident ray.
- Lens formula, $\frac{1}{v} - \frac{1}{u} = \frac{1}{f}$, gives the relationship between the object-distance (u), image-distance (v), and the focal length (f) of a spherical lens.
- Power of a lens is the reciprocal of its focal length. The SI unit of power of a lens is *dioptr*.

E X E R C I S E S

1. Which one of the following materials cannot be used to make a lens?
 (a) Water (b) Glass (c) Plastic (d) Clay
2. The image formed by a concave mirror is observed to be virtual, erect and larger than the object. Where should be the position of the object?
 (a) Between the principal focus and the centre of curvature
 (b) At the centre of curvature
 (c) Beyond the centre of curvature
 (d) Between the pole of the mirror and its principal focus.
3. Where should an object be placed in front of a convex lens to get a real image of the size of the object?
 (a) At the principal focus of the lens
 (b) At twice the focal length
 (c) At infinity
 (d) Between the optical centre of the lens and its principal focus.
4. A spherical mirror and a thin spherical lens have each a focal length of -15 cm . The mirror and the lens are likely to be
 (a) both concave.
 (b) both convex.

- (c) the mirror is concave and the lens is convex.
(d) the mirror is convex, but the lens is concave.
5. No matter how far you stand from a mirror, your image appears erect. The mirror is likely to be
- (a) only plane.
(b) only concave.
(c) only convex.
(d) either plane or convex.
6. Which of the following lenses would you prefer to use while reading small letters found in a dictionary?
- (a) A convex lens of focal length 50 cm.
(b) A concave lens of focal length 50 cm.
(c) A convex lens of focal length 5 cm.
(d) A concave lens of focal length 5 cm.
7. We wish to obtain an erect image of an object, using a concave mirror of focal length 15 cm. What should be the range of distance of the object from the mirror? What is the nature of the image? Is the image larger or smaller than the object? Draw a ray diagram to show the image formation in this case.
8. Name the type of mirror used in the following situations.
- (a) Headlights of a car.
(b) Side/rear-view mirror of a vehicle.
(c) Solar furnace.
Support your answer with reason.
9. One-half of a convex lens is covered with a black paper. Will this lens produce a complete image of the object? Verify your answer experimentally. Explain your observations.
10. An object 5 cm in length is held 25 cm away from a converging lens of focal length 10 cm. Draw the ray diagram and find the position, size and the nature of the image formed.
11. A concave lens of focal length 15 cm forms an image 10 cm from the lens. How far is the object placed from the lens? Draw the ray diagram.
12. An object is placed at a distance of 10 cm from a convex mirror of focal length 15 cm. Find the position and nature of the image.
13. The magnification produced by a plane mirror is +1. What does this mean?
14. An object 5.0 cm in length is placed at a distance of 20 cm in front of a convex mirror of radius of curvature 30 cm. Find the position of the image, its nature and size.
15. An object of size 7.0 cm is placed at 27 cm in front of a concave mirror of focal length 18 cm. At what distance from the mirror should a screen be placed, so that a sharp focussed image can be obtained? Find the size and the nature of the image.
16. Find the focal length of a lens of power -2.0 D. What type of lens is this?
17. A doctor has prescribed a corrective lens of power $+1.5$ D. Find the focal length of the lens. Is the prescribed lens diverging or converging?



CHAPTER 11

The Human Eye and the Colourful World



1064CH11

You have studied in the previous chapter about refraction of light by lenses. You also studied the nature, position and relative size of images formed by lenses. How can these ideas help us in the study of the human eye? The human eye uses light and enables us to see objects around us. It has a lens in its structure. What is the function of the lens in a human eye? How do the lenses used in spectacles correct defects of vision? Let us consider these questions in this chapter.

We have learnt in the previous chapter about light and some of its properties. In this chapter, we shall use these ideas to study some of the optical phenomena in nature. We shall also discuss about rainbow formation, splitting of white light and blue colour of the sky.

11.1 THE HUMAN EYE

The human eye is one of the most valuable and sensitive sense organs. It enables us to see the wonderful world and the colours around us. On closing the eyes, we can identify objects to some extent by their smell, taste, sound they make or by touch. It is, however, impossible to identify colours while closing the eyes. Thus, of all the sense organs, the human eye is the most significant one as it enables us to see the beautiful, colourful world around us.

The human eye is like a camera. Its lens system forms an image on a light-sensitive screen called the retina. Light enters the eye through a thin membrane called the cornea. It forms the transparent bulge on the front surface of the eyeball as shown in Fig. 11.1. The eyeball is approximately spherical in shape with a diameter of about 2.3 cm. Most of the refraction for the light rays entering the eye occurs at the outer surface of the cornea. The crystalline lens merely provides the finer adjustment of focal length required to focus objects at different distances on the retina. We find a structure called *iris* behind the cornea. Iris is a dark muscular diaphragm that controls the size of the pupil. The pupil regulates and controls the amount of light

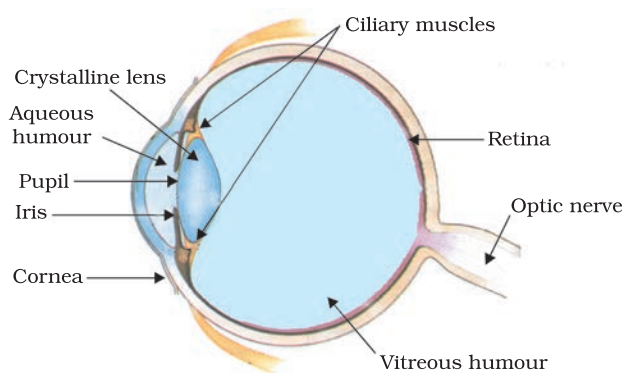

Figure 11.1
The human eye

entering the eye. The eye lens forms an inverted real image of the object on the retina. The retina is a delicate membrane having enormous number of light-sensitive cells. The light-sensitive cells get activated upon illumination and generate electrical signals. These signals are sent to the brain via the optic nerves. The brain interprets these signals, and finally, processes the information so that we perceive objects as they are.

Do You Know?

Damage to or malfunction of any part of the visual system can lead to significant loss of visual functioning. For example, if any of the structures involved in the transmission of light, like the cornea, pupil, eye lens, aqueous humour and vitreous humour or those responsible for conversion of light to electrical impulse, like the retina or even the optic nerve that transmits these impulses to the brain, is damaged, it will result in visual impairment. You might have experienced that you are not able to see objects clearly for some time when you enter from bright light to a room with dim light. After sometime, however, you may be able to see things in the dim-lit room. The pupil of an eye acts like a variable aperture whose size can be varied with the help of the iris. When the light is very bright, the iris contracts the pupil to allow less light to enter the eye. However, in dim light the iris expands the pupil to allow more light to enter the eye. Thus, the pupil opens completely through the relaxation of the iris.

11.1.1 Power of Accommodation

The eye lens is composed of a fibrous, jelly-like material. Its curvature can be modified to some extent by the ciliary muscles. The change in the curvature of the eye lens can thus change its focal length. When the muscles are relaxed, the lens becomes thin. Thus, its focal length increases. This enables us to see distant objects clearly. When you are looking at objects closer to the eye, the ciliary muscles contract. This increases the curvature of the eye lens. The eye lens then becomes thicker. Consequently, the focal length of the eye lens decreases. This enables us to see nearby objects clearly.

The ability of the eye lens to adjust its focal length is called accommodation. However, the focal length of the eye lens cannot be decreased below a certain minimum limit. Try to read a printed page by holding it very close to your eyes. You may see the image being blurred or feel strain in the eye. To see an object comfortably and distinctly, you must hold it at about 25 cm from the eyes. The minimum distance, at which objects can be seen most distinctly without strain, is called the least distance of distinct vision. It is also called the near point of the eye. For a young adult with normal vision, the near point is about 25 cm. The farthest point upto which the eye can see objects clearly is called the far point of the eye. It is infinity for a normal eye. You may note here a normal eye can see objects clearly that are between 25 cm and infinity.

Sometimes, the crystalline lens of people at old age becomes milky and cloudy. This condition is called cataract. This causes partial or complete loss of vision. It is possible to restore vision through a cataract surgery.

Why do we have two eyes for vision and not just one?

There are several advantages of our having two eyes instead of one. It gives a wider field of view. A human being has a horizontal field of view of about 150° with one eye and of about 180° with two eyes. The ability to detect faint objects is, of course, enhanced with two detectors instead of one.

Some animals, usually prey animals, have their two eyes positioned on opposite sides of their heads to give the widest possible field of view. But our two eyes are positioned on the front of our heads, and it thus reduces our field of view in favour of what is called stereopsis. Shut one eye and the world looks flat – two-dimensional. Keep both eyes open and the world takes on the third dimension of depth. Because our eyes are separated by a few centimetres, each eye sees a slightly different image. Our brain combines the two images into one, using the extra information to tell us how close or far away things are.

11.2 DEFECTS OF VISION AND THEIR CORRECTION

Sometimes, the eye may gradually lose its power of accommodation. In such conditions, the person cannot see the objects distinctly and comfortably. The vision becomes blurred due to the refractive defects of the eye.

There are mainly three common refractive defects of vision. These are (i) myopia or near-sightedness, (ii) Hypermetropia or far-sightedness, and (iii) Presbyopia. These defects can be corrected by the use of suitable spherical lenses. We discuss below these defects and their correction.

(a) Myopia

Myopia is also known as near-sightedness. A person with myopia can see nearby objects clearly but cannot see distant objects distinctly. A person with this defect has the far point nearer than infinity. Such a person may see clearly upto a distance of a few metres. In a myopic eye, the image of a distant object is formed in front of the retina [Fig. 11.2 (b)] and not at the retina itself. This defect may arise due to (i) excessive curvature of the eye lens, or (ii) elongation of the eyeball. This defect can be corrected by using a concave lens of suitable power. This is illustrated in Fig. 11.2 (c). A concave lens of suitable power will bring the image back on to the retina and thus the defect is corrected.

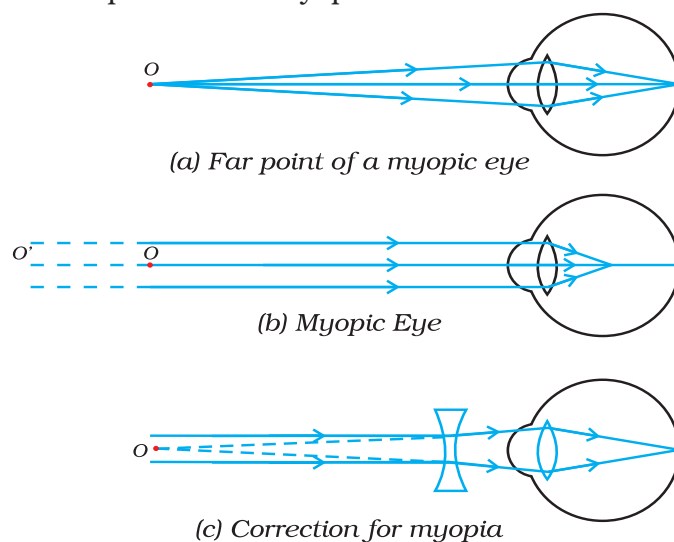

Figure 11.2

(a), (b) The myopic eye, and (c) correction for myopia with a concave lens

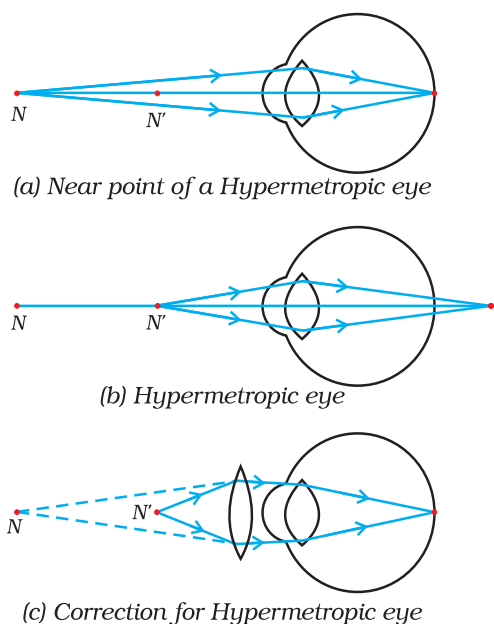

Figure 11.3
 (a), (b) The hypermetropic eye, and (c) correction for hypermetropia

N = Near point of a hypermetropic eye.

N' = Near point of a normal eye.

(b) Hypermetropia

Hypermetropia is also known as far-sightedness. A person with hypermetropia can see distant objects clearly but cannot see nearby objects distinctly. The near point, for the person, is farther away from the normal near point (25 cm). Such a person has to keep a reading material much beyond 25 cm from the eye for comfortable reading. This is because the light rays from a closeby object are focussed at a point behind the retina as shown in Fig. 11.3 (b). This defect arises either because (i) the focal length of the eye lens is too long, or (ii) the eyeball has become too small. This defect can be corrected by using a convex lens of appropriate power. This is illustrated in Fig. 11.3 (c). Eye-glasses with converging lenses provide the additional focussing power required for forming the image on the retina.

(c) Presbyopia

The power of accommodation of the eye usually decreases with ageing. For most people, the near point gradually recedes away. They find it difficult to see nearby objects comfortably and distinctly without corrective eye-glasses. This defect is called Presbyopia. It arises due to the gradual weakening of the ciliary muscles and diminishing flexibility of the eye lens.

Sometimes, a person may suffer from both myopia and hypermetropia. Such people often require bi-focal lenses. A common type of bi-focal lenses consists of both concave and convex lenses. The upper portion consists of a concave lens. It facilitates distant vision. The lower part is a convex lens. It facilitates near vision.

These days, it is possible to correct the refractive defects with contact lenses or through surgical interventions.

Q U E S T I O N S

1. What is meant by power of accommodation of the eye?
2. A person with a myopic eye cannot see objects beyond 1.2 m distinctly. What should be the type of the corrective lens used to restore proper vision?
3. What is the far point and near point of the human eye with normal vision?
4. A student has difficulty reading the blackboard while sitting in the last row. What could be the defect the child is suffering from? How can it be corrected?



Think it over



*You talk of wondrous things you see,
You say the sun shines bright;
I feel him warm, but how can he
Or make it day or night?*

– C. CIBBER

Do you know that our eyes can live even after our death? By donating our eyes after we die, we can light the life of a blind person.

About 35 million people in the developing world are blind and most of them can be cured. About 4.5 million people with corneal blindness can be cured through corneal transplantation of donated eyes. Out of these 4.5 million, 60% are children below the age of 12. So, if we have got the gift of vision, why not pass it on to somebody who does not have it? What do we have to keep in mind when eyes have to be donated?

- Eye donors can belong to any age group or sex. People who use spectacles, or those operated for cataract, can still donate the eyes. People who are diabetic, have hypertension, asthma patients and those without communicable diseases can also donate eyes.
- Eyes must be removed within 4-6 hours after death. Inform the nearest eye bank immediately.
- The eye bank team will remove the eyes at the home of the deceased or at a hospital.
- Eye removal takes only 10-15 minutes. It is a simple process and does not lead to any disfigurement.
- Persons who were infected with or died because of AIDS, Hepatitis B or C, rabies, acute leukaemia, tetanus, cholera, meningitis or encephalitis cannot donate eyes.

An eye bank collects, evaluates and distributes the donated eyes. All eyes donated are evaluated using strict medical standards. Those donated eyes found unsuitable for transplantation are used for valuable research and medical education. The identities of both the donor and the recipient remain confidential.

One pair of eyes gives vision to up to FOUR CORNEAL BLIND PEOPLE.

11.3 REFRACTION OF LIGHT THROUGH A PRISM

You have learnt how light gets refracted through a rectangular glass slab. For parallel refracting surfaces, as in a glass slab, the emergent ray is parallel to the incident ray. However, it is slightly displaced laterally. How would light get refracted through a transparent prism? Consider a triangular glass prism. It has two triangular bases and three rectangular lateral surfaces. These surfaces are inclined to each other. The angle between its two lateral faces is called the angle of the prism. Let us now do an activity to study the refraction of light through a triangular glass prism.

Activity 11.1

- Fix a sheet of white paper on a drawing board using drawing pins.
- Place a glass prism on it in such a way that it rests on its triangular base. Trace the outline of the prism using a pencil.
- Draw a straight line PE inclined to one of the refracting surfaces, say AB, of the prism.
- Fix two pins, say at points P and Q, on the line PE as shown in Fig. 11.4.
- Look for the images of the pins, fixed at P and Q, through the other face AC.
- Fix two more pins, at points R and S, such that the pins at R and S and the images of the pins at P and Q lie on the same straight line.
- Remove the pins and the glass prism.
- The line PE meets the boundary of the prism at point E (see Fig. 11.4). Similarly, join and produce the points R and S. Let these lines meet the boundary of the prism at E and F, respectively. Join E and F.
- Draw perpendiculars to the refracting surfaces AB and AC of the prism at points E and F, respectively.
- Mark the angle of incidence ($\angle i$), the angle of refraction ($\angle r$) and the angle of emergence ($\angle e$) as shown in Fig. 11.4.

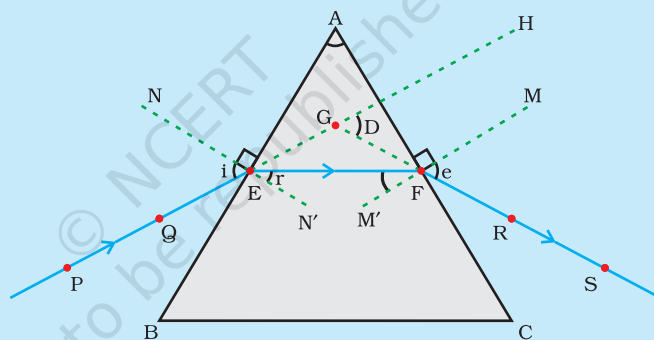

PE – Incident ray	$\angle i$ – Angle of incidence
EF – Refracted ray	$\angle r$ – Angle of refraction
FS – Emergent ray	$\angle e$ – Angle of emergence
$\angle A$ – Angle of the prism	$\angle D$ – Angle of deviation

Figure 11.4 Refraction of light through a triangular glass prism

Here PE is the incident ray, EF is the refracted ray and FS is the emergent ray. You may note that a ray of light is entering from air to glass at the first surface AB. The light ray on refraction has bent towards the normal. At the second surface AC, the light ray has entered from glass to air. Hence it has bent away from normal. Compare the angle of incidence and the angle of refraction at each refracting surface of the prism. Is this similar to the kind of bending that occurs in a glass slab? The peculiar shape of the prism makes the emergent ray bend at an angle to the direction of the incident ray. This angle is called the angle of deviation. In this case $\angle D$ is the angle of deviation. Mark the angle of deviation in the above activity and measure it.

11.4 DISPERSION OF WHITE LIGHT BY A GLASS PRISM

You must have seen and appreciated the spectacular colours in a rainbow. How could the white light of the Sun give us various colours of the rainbow? Before we take up this question, we shall first go back to the refraction of light through a prism. The inclined refracting surfaces of a glass prism show exciting phenomenon. Let us find it out through an activity.

Activity 11.2

- Take a thick sheet of cardboard and make a small hole or narrow slit in its middle.
- Allow sunlight to fall on the narrow slit. This gives a narrow beam of white light.
- Now, take a glass prism and allow the light from the slit to fall on one of its faces as shown in Fig. 11.5.
- Turn the prism slowly until the light that comes out of it appears on a nearby screen.
- What do you observe? You will find a beautiful band of colours. Why does this happen?

The prism has probably split the incident white light into a band of colours. Note the colours that appear at the two ends of the colour band. What is the sequence of colours that you see on the screen? The various colours seen are Violet, Indigo, Blue, Green, Yellow, Orange and Red, as shown in Fig. 11.5. The acronym VIBGYOR will help you to remember the sequence of colours. The band of the coloured components of a light beam is called its spectrum. You might not be able to see all the colours separately.

Yet something makes each colour distinct from the other. The splitting of light into its component colours is called dispersion.

You have seen that white light is dispersed into its seven-colour components by a prism. Why do we get these colours? Different colours of light bend through different angles with respect to the incident ray, as they pass through a prism. The red light bends the least while the violet the most. Thus the rays of each colour emerge along different paths and thus become distinct. It is the band of distinct colours that we see in a spectrum.

Isaac Newton was the first to use a glass prism to obtain the spectrum of sunlight. He tried to split the colours of the spectrum of white light further by using another similar prism. However, he could not get any more colours. He then placed a second identical prism in an inverted position with respect to the first prism, as shown in Fig. 11.6. This

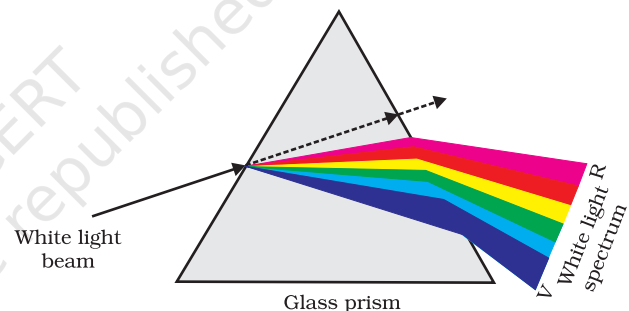

Figure 11.5 Dispersion of white light by the glass prism

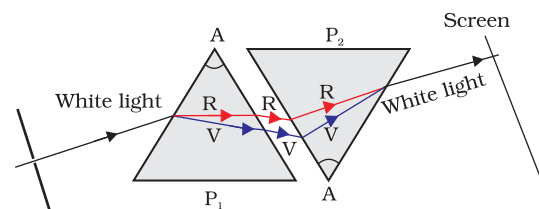

Figure 11.6 Recombination of the spectrum of white light



Figure 11.7
Rainbow in the sky

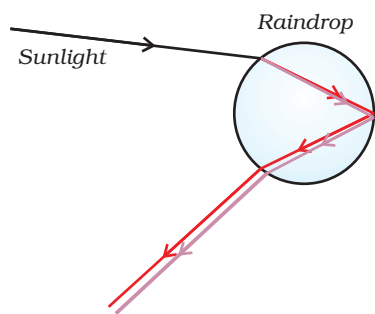

Figure 11.8
Rainbow formation

allowed all the colours of the spectrum to pass through the second prism. He found a beam of white light emerging from the other side of the second prism. This observation gave Newton the idea that the sunlight is made up of seven colours.

Any light that gives a spectrum similar to that of sunlight is often referred to as white light.

A rainbow is a natural spectrum appearing in the sky after a rain shower (Fig. 11.7). It is caused by dispersion of sunlight by tiny water droplets, present in the atmosphere. A rainbow is always formed in a direction opposite to that of the Sun. The water droplets act like small prisms. They refract and disperse the incident sunlight, then reflect it internally, and finally refract it again when it comes out of the raindrop (Fig. 11.8). Due to the dispersion of light and internal reflection, different colours reach the observer's eye.

You can also see a rainbow on a sunny day when you look at the sky through a waterfall or through a water fountain, with the Sun behind you.

11.5 ATMOSPHERIC REFRACTION

You might have observed the apparent random wavering or flickering of objects seen through a turbulent stream of hot air rising above a fire or a radiator. The air just above the fire becomes hotter than the air further up. The hotter air is lighter (less dense) than the cooler air above it, and has a refractive index slightly less than that of the cooler air. Since the physical conditions of the refracting medium (air) are not stationary, the apparent position of the object, as seen through the hot air, fluctuates. This wavering is thus an effect of atmospheric refraction (refraction of light by the earth's atmosphere) on a small scale in our local environment. The twinkling of stars is a similar phenomenon on a much larger scale. Let us see how we can explain it.

Twinkling of stars

The twinkling of a star is due to atmospheric refraction of starlight. The starlight, on entering the earth's atmosphere, undergoes refraction continuously before it reaches the earth. The atmospheric refraction occurs in a medium of gradually changing refractive index. Since the atmosphere bends starlight towards the normal, the apparent position of the star is slightly different from its actual position. The star appears slightly higher (above) than its actual position when viewed near the horizon (Fig. 11.9). Further, this apparent position of the star is not stationary, but keeps on changing slightly, since the physical conditions of the earth's atmosphere are not stationary, as was the case in the previous paragraph. Since the stars are very distant, they approximate point-sized sources of light. As the path of rays of light coming from the star goes on varying slightly, the apparent position of the star fluctuates and the amount of

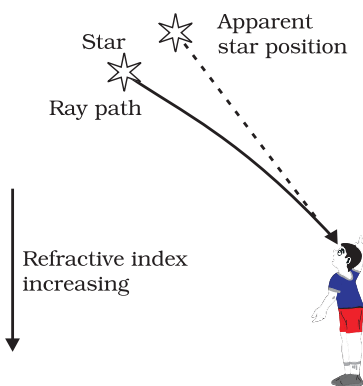

Figure 11.9
Apparent star position due to atmospheric refraction

starlight entering the eye flickers – the star sometimes appears brighter, and at some other time, fainter, which is the twinkling effect.

Why don't the planets twinkle? The planets are much closer to the earth, and are thus seen as extended sources. If we consider a planet as a collection of a large number of point-sized sources of light, the total variation in the amount of light entering our eye from all the individual point-sized sources will average out to zero, thereby nullifying the twinkling effect.

Advance sunrise and delayed sunset

The Sun is visible to us about 2 minutes before the actual sunrise, and about 2 minutes after the actual sunset because of atmospheric refraction. By actual sunrise, we mean the actual crossing of the horizon by the Sun. Fig. 11.10 shows the actual and apparent positions of the Sun with respect to the horizon. The time difference between actual sunset and the apparent sunset is about 2 minutes. The apparent flattening of the Sun's disc at sunrise and sunset is also due to the same phenomenon.

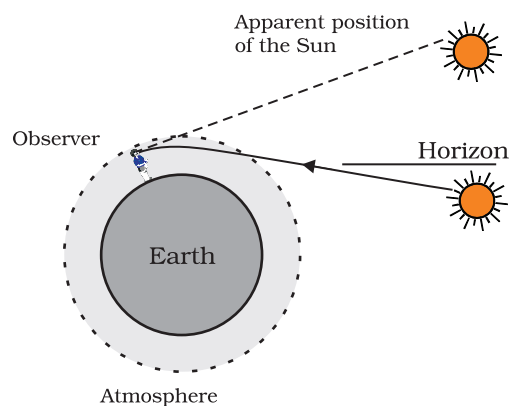

Figure 11.10
Atmospheric refraction effects at sunrise and sunset

11.6 SCATTERING OF LIGHT

The interplay of light with objects around us gives rise to several spectacular phenomena in nature. The blue colour of the sky, colour of water in deep sea, the reddening of the sun at sunrise and the sunset are some of the wonderful phenomena we are familiar with. In the previous class, you have learnt about the scattering of light by colloidal particles. The path of a beam of light passing through a true solution is not visible. However, its path becomes visible through a colloidal solution where the size of the particles is relatively larger.

11.6.1 Tyndall Effect

The earth's atmosphere is a heterogeneous mixture of minute particles. These particles include smoke, tiny water droplets, suspended particles of dust and molecules of air. When a beam of light strikes such fine particles, the path of the beam becomes visible. The light reaches us, after being reflected diffusely by these particles. The phenomenon of scattering of light by the colloidal particles gives rise to Tyndall effect which you have studied in Class IX. This phenomenon is seen when a fine beam of sunlight enters a smoke-filled room through a small hole. Thus, scattering of light makes the particles visible. Tyndall effect can also be observed when sunlight passes through a canopy of a dense forest. Here, tiny water droplets in the mist scatter light.

The colour of the scattered light depends on the size of the scattering particles. Very fine particles scatter mainly blue light while particles of larger size scatter light of longer wavelengths. If the size of the scattering particles is large enough, then, the scattered light may even appear white.

11.6.2 Why is the colour of the clear Sky Blue?

The molecules of air and other fine particles in the atmosphere have size smaller than the wavelength of visible light. These are more effective in scattering light of shorter wavelengths at the blue end than light of longer wavelengths at the red end. The red light has a wavelength about 1.8 times greater than blue light. Thus, when sunlight passes through the atmosphere, the fine particles in air scatter the blue colour (shorter wavelengths) more strongly than red. The scattered blue light enters our eyes. If the earth had no atmosphere, there would not have been any scattering. Then, the sky would have looked dark. The sky appears dark to passengers flying at very high altitudes, as scattering is not prominent at such heights.

You might have observed that 'danger' signal lights are red in colour. Do you know why? The red is least scattered by fog or smoke. Therefore, it can be seen in the same colour at a distance.

11.6.3 Colour of the Sun at Sunrise and Sunset

Have you seen the sky and the Sun at sunset or sunrise? Have you wondered as to why the Sun and the surrounding sky appear red? Let us do an activity to understand the blue colour of the sky and the reddish appearance of the Sun at the sunrise or sunset.

Activity 11.3

- Place a strong source (S) of white light at the focus of a converging lens (L_1). This lens provides a parallel beam of light.
- Allow the light beam to pass through a transparent glass tank (T) containing clear water.
- Allow the beam of light to pass through a circular hole (c) made in a cardboard. Obtain a sharp image of the circular hole on a screen (MN) using a second converging lens (L_2), as shown in Fig. 11.11.
- Dissolve about 200 g of sodium thiosulphate (hypo) in about 2 L of clean water taken in the tank. Add about 1 to 2 mL of concentrated sulphuric acid to the water. What do you observe?

You will find fine microscopic sulphur particles precipitating in about 2 to 3 minutes. As the sulphur particles begin to form, you can observe

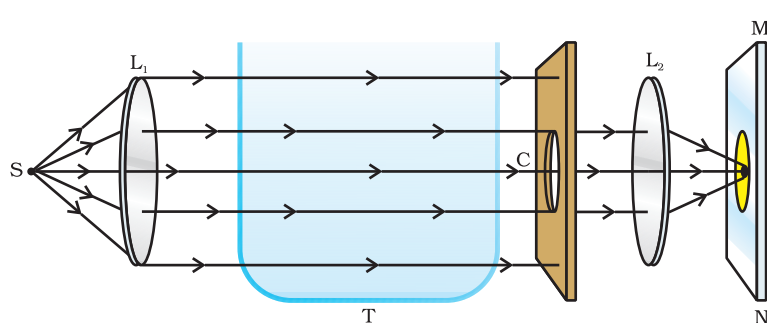

Figure 11.11
An arrangement for observing scattering of light in colloidal solution

the blue light from the three sides of the glass tank. This is due to scattering of short wavelengths by minute colloidal sulphur particles. Observe the colour of the transmitted light from the fourth side of the glass tank facing the circular hole. It is interesting to observe at first the orange red colour and then bright crimson red colour on the screen.

This activity demonstrates the scattering of light that helps you to understand the bluish colour of the sky and the reddish appearance of the Sun at the sunrise or the sunset.

Light from the Sun near the horizon passes through thicker layers of air and larger distance in the earth's atmosphere before reaching our eyes (Fig. 11.12).

However, light from the Sun overhead would travel relatively shorter distance. At noon, the Sun appears white as only a little of the blue and violet colours are scattered. Near the horizon, most of the blue light and shorter wavelengths are scattered away by the particles. Therefore, the light that reaches our eyes is of longer wavelengths. This gives rise to the reddish appearance of the Sun.

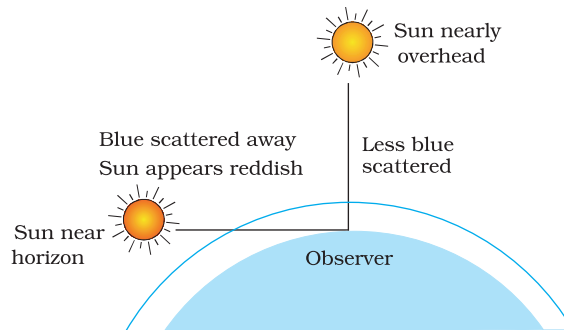

Figure 11.12
Reddening of the Sun at sunrise and sunset

What you have learnt

- The ability of the eye to focus on both near and distant objects, by adjusting its focal length, is called the accommodation of the eye.
- The smallest distance, at which the eye can see objects clearly without strain, is called the near point of the eye or the least distance of distinct vision. For a young adult with normal vision, it is about 25 cm.
- The common refractive defects of vision include myopia, hypermetropia and presbyopia. Myopia (short-sightedness – the image of distant objects is focussed before the retina) is corrected by using a concave lens of suitable power. Hypermetropia (far-sightedness – the image of nearby objects is focussed beyond the retina) is corrected by using a convex lens of suitable power. The eye loses its power of accommodation at old age.
- The splitting of white light into its component colours is called dispersion.
- Scattering of light causes the blue colour of sky and the reddening of the Sun at sunrise and sunset.

EXERCISES

1. The human eye can focus on objects at different distances by adjusting the focal length of the eye lens. This is due to
 - (a) presbyopia.
 - (b) accommodation.
 - (c) near-sightedness.
 - (d) far-sightedness.

2. The human eye forms the image of an object at its
(a) cornea. (b) iris. (c) pupil. (d) retina.
3. The least distance of distinct vision for a young adult with normal vision is about
(a) 25 m. (b) 2.5 cm. (c) 25 cm. (d) 2.5 m.
4. The change in focal length of an eye lens is caused by the action of the
(a) pupil. (b) retina.
(c) ciliary muscles. (d) iris.
5. A person needs a lens of power -5.5 dioptres for correcting his distant vision. For correcting his near vision he needs a lens of power $+1.5$ dioptre. What is the focal length of the lens required for correcting (i) distant vision, and (ii) near vision?
6. The far point of a myopic person is 80 cm in front of the eye. What is the nature and power of the lens required to correct the problem?
7. Make a diagram to show how hypermetropia is corrected. The near point of a hypermetropic eye is 1 m. What is the power of the lens required to correct this defect? Assume that the near point of the normal eye is 25 cm.
8. Why is a normal eye not able to see clearly the objects placed closer than 25 cm?
9. What happens to the image distance in the eye when we increase the distance of an object from the eye?
10. Why do stars twinkle?
11. Explain why the planets do not twinkle.
12. Why does the Sun appear reddish early in the morning?
13. Why does the sky appear dark instead of blue to an astronaut?

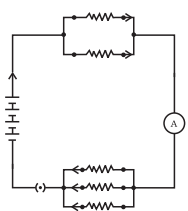

CHAPTER 12

Electricity



1064CH12

Electricity has an important place in modern society. It is a controllable and convenient form of energy for a variety of uses in homes, schools, hospitals, industries and so on. What constitutes electricity? How does it flow in an electric circuit? What are the factors that control or regulate the current through an electric circuit? In this Chapter, we shall attempt to answer such questions. We shall also discuss the heating effect of electric current and its applications.

12.1 ELECTRIC CURRENT AND CIRCUIT

We are familiar with air current and water current. We know that flowing water constitute water current in rivers. Similarly, if the electric charge flows through a conductor (for example, through a metallic wire), we say that there is an electric current in the conductor. In a torch, we know that the cells (or a battery, when placed in proper order) provide flow of charges or an electric current through the torch bulb to glow. We have also seen that the torch gives light only when its switch is *on*. What does a switch do? A switch makes a conducting link between the cell and the bulb. A continuous and closed path of an electric current is called an electric circuit. Now, if the circuit is broken anywhere (or the switch of the torch is turned *off*), the current stops flowing and the bulb does not glow.

How do we express electric current? Electric current is expressed by the amount of charge flowing through a particular area in unit time. In other words, it is the rate of flow of electric charges. In circuits using metallic wires, electrons constitute the flow of charges. However, electrons were not known at the time when the phenomenon of electricity was first observed. So, electric current was considered to be the flow of positive charges and the direction of flow of positive charges was taken to be the direction of electric current. Conventionally, in an electric circuit the direction of electric current is taken as opposite to the direction of the flow of electrons, which are negative charges.

If a net charge Q , flows across any cross-section of a conductor in time t , then the current I , through the cross-section is

$$I = \frac{Q}{t} \quad (12.1)$$

The SI unit of electric charge is coulomb (C), which is equivalent to the charge contained in nearly 6×10^{18} electrons. (We know that an electron possesses a negative charge of 1.6×10^{-19} C.) The electric current is expressed by a unit called ampere (A), named after the French scientist, Andre-Marie Ampere (1775–1836). One ampere is constituted by the flow of one coulomb of charge per second, that is, $1 \text{ A} = 1 \text{ C}/1 \text{ s}$. Small quantities of current are expressed in milliampere

($1 \text{ mA} = 10^{-3} \text{ A}$) or in microampere ($1 \mu\text{A} = 10^{-6} \text{ A}$). An instrument called ammeter measures electric current in a circuit. It is always connected in series in a circuit through which the current is to be measured. Figure 12.1 shows the schematic diagram of a typical electric circuit comprising a cell, an electric bulb, an ammeter and a plug key. Note that the electric current flows in the circuit from the positive terminal of the cell to the negative terminal of the cell through the bulb and ammeter.

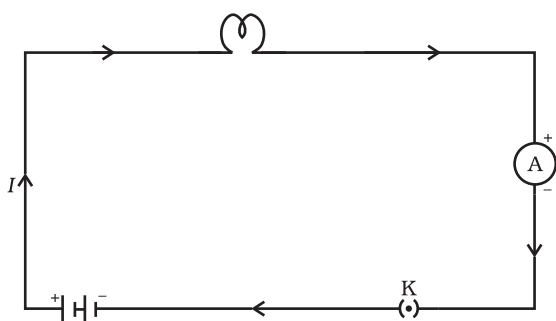

Figure 12.1
A schematic diagram of an electric circuit comprising – cell, electric bulb, ammeter and plug key

Example 12.1

A current of 0.5 A is drawn by a filament of an electric bulb for 10 minutes. Find the amount of electric charge that flows through the circuit.

Solution

We are given, $I = 0.5 \text{ A}$; $t = 10 \text{ min} = 600 \text{ s}$.

From Eq. (12.1), we have

$$\begin{aligned} Q &= It \\ &= 0.5 \text{ A} \times 600 \text{ s} \\ &= 300 \text{ C} \end{aligned}$$

Q U E S T I O N S

1. What does an electric circuit mean?
2. Define the unit of current.
3. Calculate the number of electrons constituting one coulomb of charge.



'Flow' of charges inside a wire

How does a metal conduct electricity? You would think that a low-energy electron would have great difficulty passing through a solid conductor. Inside the solid, the atoms are packed together with very little spacing between them. But it turns out that the electrons are able to 'travel' through a perfect solid crystal smoothly and easily, almost as if they were in a vacuum. The 'motion' of electrons in a conductor, however, is very different from that of charges in empty space. When a steady current flows through a conductor, the electrons in it move with a certain average 'drift speed'. One can calculate this drift speed of electrons for a typical copper wire carrying a small current, and it is found to be actually very small, of the order of 1 mm s^{-1} . How is it then that an electric bulb lights up as soon as we turn the switch *on*? It cannot be that a current starts only when an electron from one terminal of the electric supply physically reaches the other terminal through the bulb, because the physical drift of electrons in the conducting wires is a very slow process. The exact mechanism of the current flow, which takes place with a speed close to the speed of light, is fascinating, but it is beyond the scope of this book. Do you feel like probing this question at an advanced level?

12.2 ELECTRIC POTENTIAL AND POTENTIAL DIFFERENCE

What makes the electric charge to flow? Let us consider the analogy of flow of water. Charges do not flow in a copper wire by themselves, just as water in a perfectly horizontal tube does not flow. If one end of the tube is connected to a tank of water kept at a higher level, such that there is a pressure difference between the two ends of the tube, water flows out of the other end of the tube. For flow of charges in a conducting metallic wire, the gravity, of course, has no role to play; the electrons move only if there is a difference of electric pressure – called the *potential difference* – along the conductor. This difference of potential may be produced by a battery, consisting of one or more electric cells. The chemical action within a cell generates the potential difference across the terminals of the cell, even when no current is drawn from it. When the cell is connected to a conducting circuit element, the potential difference sets the charges in motion in the conductor and produces an electric current. In order to maintain the current in a given electric circuit, the cell has to expend its chemical energy stored in it.

We define the electric potential difference between two points in an electric circuit carrying some current as the work done to move a unit charge from one point to the other –

Potential difference (V) between two points = Work done (W)/Charge (Q)

$$V = W/Q \quad (12.2)$$

The SI unit of electric potential difference is volt (V), named after Alessandro Volta (1745–1827), an Italian physicist. One volt is the

potential difference between two points in a current carrying conductor when 1 joule of work is done to move a charge of 1 coulomb from one point to the other.

$$\text{Therefore, } 1 \text{ volt} = \frac{1 \text{ joule}}{1 \text{ coulomb}} \quad (12.3)$$

$$1 \text{ V} = 1 \text{ J C}^{-1}$$

The potential difference is measured by means of an instrument called the voltmeter. The voltmeter is always connected in parallel across the points between which the potential difference is to be measured.

Example 12.2

How much work is done in moving a charge of 2 C across two points having a potential difference 12 V?

Solution

The amount of charge Q , that flows between two points at potential difference V ($= 12 \text{ V}$) is 2 C. Thus, the amount of work W , done in moving the charge [from Eq. (12.2)] is

$$\begin{aligned} W &= VQ \\ &= 12 \text{ V} \times 2 \text{ C} \\ &= 24 \text{ J.} \end{aligned}$$

Q U E S T I O N S









1. Name a device that helps to maintain a potential difference across a conductor.
2. What is meant by saying that the potential difference between two points is 1 V?
3. How much energy is given to each coulomb of charge passing through a 6 V battery?

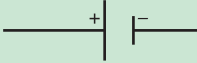
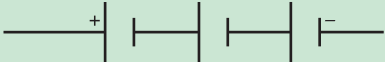

12.3 CIRCUIT DIAGRAM

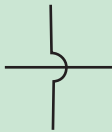
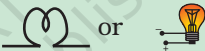
We know that an electric circuit, as shown in Fig. 12.1, comprises a cell (or a battery), a plug key, electrical component(s), and connecting wires. It is often convenient to draw a schematic diagram, in which different components of the circuit are represented by the symbols conveniently used. Conventional symbols used to represent some of the most commonly used electrical components are given in Table 12.1.

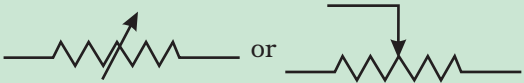
Table 12.1 Symbols of some commonly used components in circuit diagrams

Sl. No.	Components	Symbols
1	An electric cell	
2	A battery or a combination of cells	
3	Plug key or switch (open)	
4	Plug key or switch (closed)	
5	A wire joint	
6	Wires crossing without joining	
7	Electric bulb	
8	A resistor of resistance R	
9	Variable resistance or rheostat	
10	Ammeter	
11	Voltmeter	

12.4 OHM'S LAW

Is there a relationship between the potential difference across a conductor and the current through it? Let us explore with an Activity.

Activity 12.1

- Set up a circuit as shown in Fig. 12.2, consisting of a nichrome wire XY of length, say 0.5 m, an ammeter, a voltmeter and four cells of 1.5 V each. (Nichrome is an alloy of nickel, chromium, manganese, and iron metals.)

- First use only one cell as the source in the circuit. Note the reading in the ammeter I , for the current and reading of the voltmeter V for the potential difference across the nichrome wire XY in the circuit. Tabulate them in the Table given.
- Next connect two cells in the circuit and note the respective readings of the ammeter and voltmeter for the values of current through the nichrome wire and potential difference across the nichrome wire.
- Repeat the above steps using three cells and then four cells in the circuit separately.
- Calculate the ratio of V to I for each pair of potential difference V and current I .

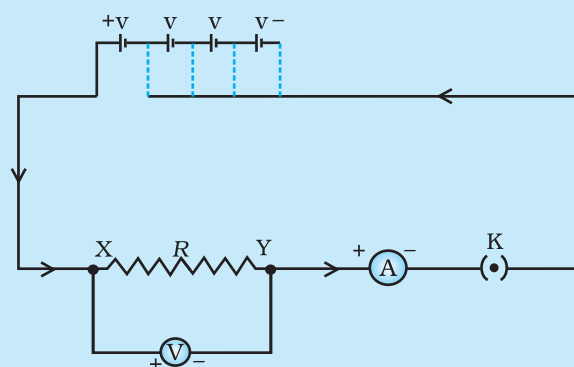

Figure 12.2 Electric circuit for studying Ohm's law

S. No.	Number of cells used in the circuit	Current through the nichrome wire, I (ampere)	Potential difference across the nichrome wire, V (volt)	V/I (volt/ampere)
1	1			
2	2			
3	3			
4	4			

- Plot a graph between V and I , and observe the nature of the graph.

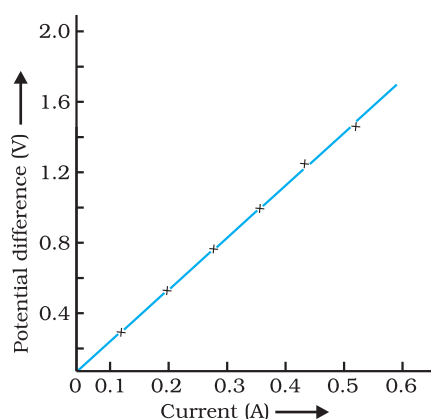

Figure 12.3

V - I graph for a nichrome wire. A straight line plot shows that as the current through a wire increases, the potential difference across the wire increases linearly – this is Ohm's law.

In this Activity, you will find that approximately the same value for V/I is obtained in each case. Thus the V - I graph is a straight line that passes through the origin of the graph, as shown in Fig. 12.3. Thus, V/I is a constant ratio.

In 1827, a German physicist Georg Simon Ohm (1787–1854) found out the relationship between the current I , flowing in a metallic wire and the potential difference across its terminals. The potential difference, V , across the ends of a given metallic wire in an electric circuit is directly proportional to the current flowing through it, provided its temperature remains the same. This is called Ohm's law. In other words –

$$V \propto I \quad (12.4)$$

$$\text{or } V/I = \text{constant}$$

$$\text{or } V = IR \quad (12.5)$$

In Eq. (12.4), R is a constant for the given metallic wire at a given temperature and is called its resistance. It is the property of a conductor to resist the flow of charges

through it. Its SI unit is ohm, represented by the Greek letter Ω . According to Ohm's law,

$$R = V/I \quad (12.6)$$

If the potential difference across the two ends of a conductor is 1 V and the current through it is 1 A, then the resistance R , of the conductor

is 1 Ω . That is, 1 ohm = $\frac{1 \text{ volt}}{1 \text{ ampere}}$

Also from Eq. (12.5) we get

$$I = V/R \quad (12.7)$$

It is obvious from Eq. (12.7) that the current through a resistor is inversely proportional to its resistance. If the resistance is doubled the current gets halved. In many practical cases it is necessary to increase or decrease the current in an electric circuit. A component used to regulate current without changing the voltage source is called variable resistance. In an electric circuit, a device called rheostat is often used to change the resistance in the circuit. We will now study about electrical resistance of a conductor with the help of following Activity.

Activity 12.2

- Take a nichrome wire, a torch bulb, a 10 W bulb and an ammeter (0 – 5 A range), a plug key and some connecting wires.
- Set up the circuit by connecting four dry cells of 1.5 V each in series with the ammeter leaving a gap XY in the circuit, as shown in Fig. 12.4.

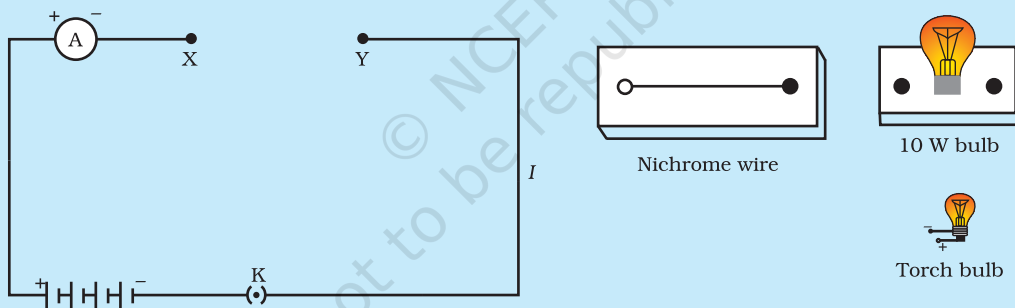

Figure 12.4

- Complete the circuit by connecting the nichrome wire in the gap XY. Plug the key. Note down the ammeter reading. Take out the key from the plug. [Note: Always take out the key from the plug after measuring the current through the circuit.]
- Replace the nichrome wire with the torch bulb in the circuit and find the current through it by measuring the reading of the ammeter.
- Now repeat the above step with the 10 W bulb in the gap XY.
- Are the ammeter readings different for different components connected in the gap XY? What do the above observations indicate?
- You may repeat this Activity by keeping any material component in the gap. Observe the ammeter readings in each case. Analyse the observations.

In this Activity we observe that the current is different for different components. Why do they differ? Certain components offer an easy path for the flow of electric current while the others resist the flow. We know

that motion of electrons in an electric circuit constitutes an electric current. The electrons, however, are not completely free to move within a conductor. They are restrained by the attraction of the atoms among which they move. Thus, motion of electrons through a conductor is retarded by its resistance. A component of a given size that offers a low resistance is a good conductor. A conductor having some appreciable resistance is called a resistor. A component of identical size that offers a higher resistance is a poor conductor. An insulator of the same size offers even higher resistance.

12.5 FACTORS ON WHICH THE RESISTANCE OF A CONDUCTOR DEPENDS

Activity 12.3

- Complete an electric circuit consisting of a cell, an ammeter, a nichrome wire of length l [say, marked (1)] and a plug key, as shown in Fig. 12.5.

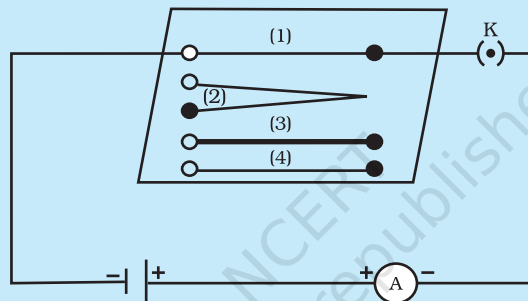

Figure 12.5 Electric circuit to study the factors on which the resistance of conducting wires depends

- Now, plug the key. Note the current in the ammeter.
- Replace the nichrome wire by another nichrome wire of same thickness but twice the length, that is $2l$ [marked (2) in the Fig. 12.5].
- Note the ammeter reading.
- Now replace the wire by a thicker nichrome wire, of the same length l [marked (3)]. A thicker wire has a larger cross-sectional area. Again note down the current through the circuit.
- Instead of taking a nichrome wire, connect a copper wire [marked (4) in Fig. 12.5] in the circuit. Let the wire be of the same length and same area of cross-section as that of the first nichrome wire [marked (1)]. Note the value of the current.
- Notice the difference in the current in all cases.
- Does the current depend on the length of the conductor?
- Does the current depend on the area of cross-section of the wire used?

It is observed that the ammeter reading decreases to one-half when the length of the wire is doubled. The ammeter reading is increased when a thicker wire of the same material and of the same length is used in the circuit. A change in ammeter reading is observed when a wire of different material of the same length and the same area of cross-section is used. On applying Ohm's law [Eqs. (12.5) – (12.7)], we observe that the

resistance of the conductor depends (i) on its length, (ii) on its area of cross-section, and (iii) on the nature of its material. Precise measurements have shown that resistance of a uniform metallic conductor is directly proportional to its length (l) and inversely proportional to the area of cross-section (A). That is,

$$R \propto l \quad (12.8)$$

$$\text{and } R \propto 1/A \quad (12.9)$$

Combining Eqs. (12.8) and (12.9) we get

$$R \propto \frac{l}{A}$$

$$\text{or, } R = \rho \frac{l}{A} \quad (12.10)$$

where ρ (rho) is a constant of proportionality and is called the electrical resistivity of the material of the conductor. The SI unit of resistivity is $\Omega \text{ m}$. It is a characteristic property of the material. The metals and alloys have very low resistivity in the range of $10^{-8} \Omega \text{ m}$ to $10^{-6} \Omega \text{ m}$. They are good conductors of electricity. Insulators like rubber and glass have resistivity of the order of 10^{12} to $10^{17} \Omega \text{ m}$. Both the resistance and resistivity of a material vary with temperature.

Table 12.2 reveals that the resistivity of an alloy is generally higher than that of its constituent metals. Alloys do not oxidise (burn) readily at high temperatures. For this reason, they are commonly used in electrical heating devices, like electric iron, toasters etc. Tungsten is used almost exclusively for filaments of electric bulbs, whereas copper and aluminium are generally used for electrical transmission lines.

Table 12.2 Electrical resistivity* of some substances at 20°C

	Material	Resistivity ($\Omega \text{ m}$)
Conductors	Silver	1.60×10^{-8}
	Copper	1.62×10^{-8}
	Aluminium	2.63×10^{-8}
	Tungsten	5.20×10^{-8}
	Nickel	6.84×10^{-8}
	Iron	10.0×10^{-8}
	Chromium	12.9×10^{-8}
	Mercury	94.0×10^{-8}
	Manganese	1.84×10^{-6}
Alloys	Constantan (alloy of Cu and Ni)	49×10^{-6}
	Manganin (alloy of Cu, Mn and Ni)	44×10^{-6}
	Nichrome (alloy of Ni, Cr, Mn and Fe)	100×10^{-6}
Insulators	Glass	$10^{10} - 10^{14}$
	Hard rubber	$10^{13} - 10^{16}$
	Ebonite	$10^{15} - 10^{17}$
	Diamond	$10^{12} - 10^{13}$
	Paper (dry)	10^{12}

* You need not memorise these values. You can use these values for solving numerical problems.

Example 12.3

- (a) How much current will an electric bulb draw from a 220 V source, if the resistance of the bulb filament is 1200 Ω ? (b) How much current will an electric heater coil draw from a 220 V source, if the resistance of the heater coil is 100 Ω ?

Solution

(a) We are given $V = 220$ V; $R = 1200$ Ω .

From Eq. (12.6), we have the current $I = 220$ V/1200 $\Omega = 0.18$ A.

(b) We are given, $V = 220$ V, $R = 100$ Ω .

From Eq. (12.6), we have the current $I = 220$ V/100 $\Omega = 2.2$ A.

Note the difference of current drawn by an electric bulb and electric heater from the same 220 V source!

Example 12.4

The potential difference between the terminals of an electric heater is 60 V when it draws a current of 4 A from the source. What current will the heater draw if the potential difference is increased to 120 V?

Solution

We are given, potential difference $V = 60$ V, current $I = 4$ A.

According to Ohm's law, $R = \frac{V}{I} = \frac{60 \text{ V}}{4 \text{ A}} = 15 \text{ } \Omega$.

When the potential difference is increased to 120 V the current is given by

$$\text{current} = \frac{V}{R} = \frac{120 \text{ V}}{15 \text{ } \Omega} = 8 \text{ A}.$$

The current through the heater becomes 8 A.

Example 12.5

Resistance of a metal wire of length 1 m is 26 Ω at 20°C. If the diameter of the wire is 0.3 mm, what will be the resistivity of the metal at that temperature? Using Table 12.2, predict the material of the wire.

Solution

We are given the resistance R of the wire = 26 Ω , the diameter $d = 0.3$ mm = 3×10^{-4} m, and the length l of the wire = 1 m.

Therefore, from Eq. (12.10), the resistivity of the given metallic wire is

$$\rho = (RA/l) = (R\pi d^2/4l)$$

Substitution of values in this gives

$$\rho = 1.84 \times 10^{-6} \text{ } \Omega \text{ m}$$

The resistivity of the metal at 20°C is 1.84×10^{-6} Ω m. From Table 12.2, we see that this is the resistivity of manganese.

Example 12.6

A wire of given material having length l and area of cross-section A has a resistance of $4\ \Omega$. What would be the resistance of another wire of the same material having length $l/2$ and area of cross-section $2A$?

Solution

For first wire

$$R_1 = \rho \frac{l}{A} = 4\ \Omega$$

Now for second wire

$$R_2 = \rho \frac{l/2}{2A} = \frac{1}{4} \rho \frac{l}{A}$$

$$R_2 = \frac{1}{4} R_1$$

$$R_2 = 1\ \Omega$$

The resistance of the new wire is $1\ \Omega$.

Q U E S T I O N S

1. On what factors does the resistance of a conductor depend?
2. Will current flow more easily through a thick wire or a thin wire of the same material, when connected to the same source? Why?
3. Let the resistance of an electrical component remains constant while the potential difference across the two ends of the component decreases to half of its former value. What change will occur in the current through it?
4. Why are coils of electric toasters and electric irons made of an alloy rather than a pure metal?
5. Use the data in Table 12.2 to answer the following –
 - (a) Which among iron and mercury is a better conductor?
 - (b) Which material is the best conductor?



12.6 RESISTANCE OF A SYSTEM OF RESISTORS

In preceding sections, we learnt about some simple electric circuits. We have noticed how the current through a conductor depends upon its resistance and the potential difference across its ends. In various electrical gadgets, we often use resistors in various combinations. We now therefore intend to see how Ohm's law can be applied to combinations of resistors.

There are two methods of joining the resistors together. Figure 12.6 shows an electric circuit in which three resistors having resistances R_1 , R_2 and R_3 , respectively, are joined end to end. Here the resistors are said to be connected in series.

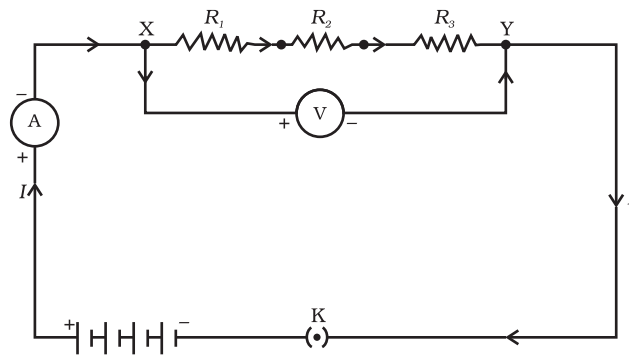

Figure 12.6 Resistors in series

Figure 12.7 shows a combination of resistors in which three resistors are connected together between points X and Y. Here, the resistors are said to be connected in parallel.

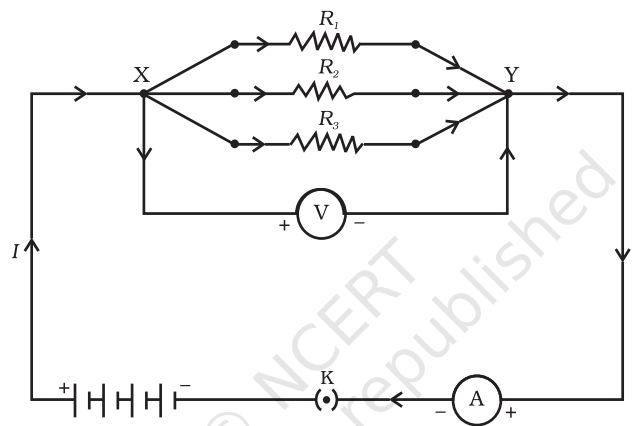

Figure 12.7 Resistors in parallel

12.6.1 Resistors in Series

What happens to the value of current when a number of resistors are connected in series in a circuit? What would be their equivalent resistance? Let us try to understand these with the help of the following activities.

Activity 12.4

- Join three resistors of different values in series. Connect them with a battery, an ammeter and a plug key, as shown in Fig. 12.6. You may use the resistors of values like $1\ \Omega$, $2\ \Omega$, $3\ \Omega$ etc., and a battery of $6\ \text{V}$ for performing this Activity.
- Plug the key. Note the ammeter reading.
- Change the position of ammeter to anywhere in between the resistors. Note the ammeter reading each time.
- Do you find any change in the value of current through the ammeter?

You will observe that the value of the current in the ammeter is the same, independent of its position in the electric circuit. It means that in a series combination of resistors the current is the same in every part of the circuit or the same current through each resistor.

Activity 12.5

- In Activity 12.4, insert a voltmeter across the ends X and Y of the series combination of three resistors, as shown in Fig. 12.6.
- Plug the key in the circuit and note the voltmeter reading. It gives the potential difference across the series combination of resistors. Let it be V . Now measure the potential difference across the two terminals of the battery. Compare the two values.
- Take out the plug key and disconnect the voltmeter. Now insert the voltmeter across the ends X and P of the first resistor, as shown in Fig. 12.8.

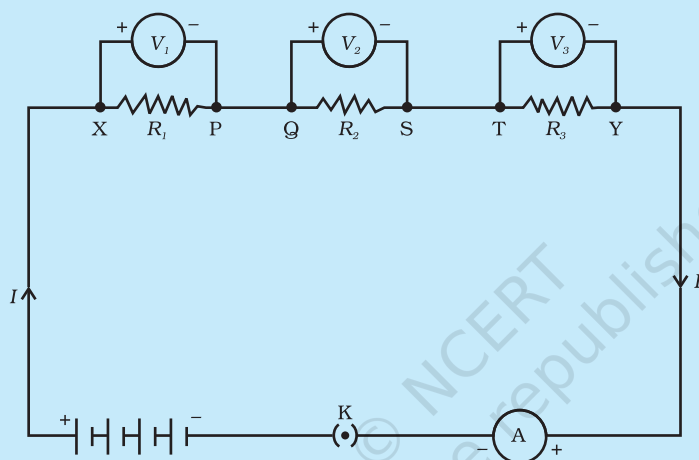

Figure 12.8

- Plug the key and measure the potential difference across the first resistor. Let it be V_1 .
- Similarly, measure the potential difference across the other two resistors, separately. Let these values be V_2 and V_3 , respectively.
- Deduce a relationship between V , V_1 , V_2 and V_3 .

You will observe that the potential difference V is equal to the sum of potential differences V_1 , V_2 , and V_3 . That is the total potential difference across a combination of resistors in series is equal to the sum of potential difference across the individual resistors. That is,

$$V = V_1 + V_2 + V_3 \quad (12.11)$$

In the electric circuit shown in Fig. 12.8, let I be the current through the circuit. The current through each resistor is also I . It is possible to replace the three resistors joined in series by an equivalent single resistor of resistance R , such that the potential difference V across it, and the current I through the circuit remains the same. Applying the Ohm's law to the entire circuit, we have

$$V = IR \quad (12.12)$$

On applying Ohm's law to the three resistors separately, we further have

$$V_1 = IR_1 \quad [12.13(a)]$$

$$V_2 = IR_2 \quad [12.13(b)]$$

and $V_3 = IR_3 \quad [12.13(c)]$

From Eq. (12.11),

$$IR = IR_1 + IR_2 + IR_3$$

or

$$R_s = R_1 + R_2 + R_3 \quad (12.14)$$

We can conclude that when several resistors are joined in series, the resistance of the combination R_s equals the sum of their individual resistances, R_1, R_2, R_3 , and is thus greater than any individual resistance.

Example 12.7

An electric lamp, whose resistance is 20Ω , and a conductor of 4Ω resistance are connected to a 6 V battery (Fig. 12.9). Calculate (a) the total resistance of the circuit, (b) the current through the circuit, and (c) the potential difference across the electric lamp and conductor.

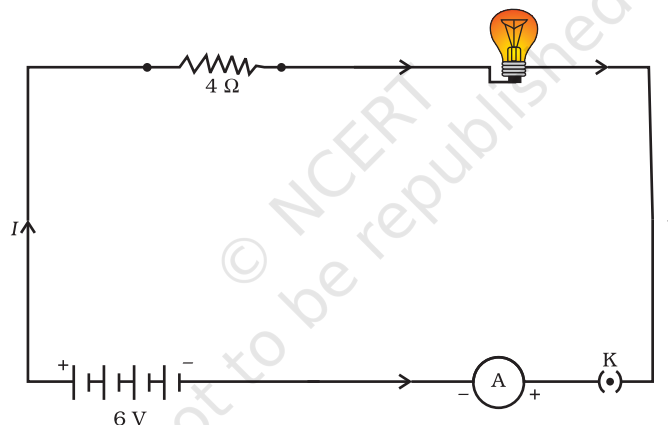

Figure 12.9 An electric lamp connected in series with a resistor of 4Ω to a 6 V battery

Solution

The resistance of electric lamp, $R_1 = 20 \Omega$,

The resistance of the conductor connected in series, $R_2 = 4 \Omega$.

Then the total resistance in the circuit

$$R = R_1 + R_2$$

$$R_s = 20 \Omega + 4 \Omega = 24 \Omega.$$

The total potential difference across the two terminals of the battery $V = 6 \text{ V}$.

Now by Ohm's law, the current through the circuit is given by

$$\begin{aligned} I &= V/R_s \\ &= 6 \text{ V}/24 \Omega \\ &= 0.25 \text{ A}. \end{aligned}$$

Applying Ohm's law to the electric lamp and conductor separately, we get potential difference across the electric lamp,

$$\begin{aligned} V_1 &= 20 \Omega \times 0.25 \text{ A} \\ &= 5 \text{ V}; \end{aligned}$$

and,

$$\begin{aligned} \text{that across the conductor, } V_2 &= 4 \Omega \times 0.25 \text{ A} \\ &= 1 \text{ V}. \end{aligned}$$

Suppose that we like to replace the series combination of electric lamp and conductor by a single and equivalent resistor. Its resistance must be such that a potential difference of 6 V across the battery terminals will cause a current of 0.25 A in the circuit. The resistance R of this equivalent resistor would be

$$\begin{aligned} R &= V/I \\ &= 6 \text{ V} / 0.25 \text{ A} \\ &= 24 \Omega. \end{aligned}$$

This is the total resistance of the series circuit; it is equal to the sum of the two resistances.

Q U E S T I O N S

1. Draw a schematic diagram of a circuit consisting of a battery of three cells of 2 V each, a 5 Ω resistor, an 8 Ω resistor, and a 12 Ω resistor, and a plug key, all connected in series.
2. Redraw the circuit of Question 1, putting in an ammeter to measure the current through the resistors and a voltmeter to measure the potential difference across the 12 Ω resistor. What would be the readings in the ammeter and the voltmeter?



12.6.2 Resistors in Parallel

Now, let us consider the arrangement of three resistors joined in parallel with a combination of cells (or a battery), as shown in Fig. 12.7.

Activity 12.6

- Make a parallel combination, XY, of three resistors having resistances R_1 , R_2 , and R_3 , respectively. Connect it with a battery, a plug key and an ammeter, as shown in Fig. 12.10. Also connect a voltmeter in parallel with the combination of resistors.
- Plug the key and note the ammeter reading. Let the current be I . Also take the voltmeter reading. It gives the potential difference V , across the combination. The potential difference across each resistor is also V . This can be checked by connecting the voltmeter across each individual resistor (see Fig. 12.11).

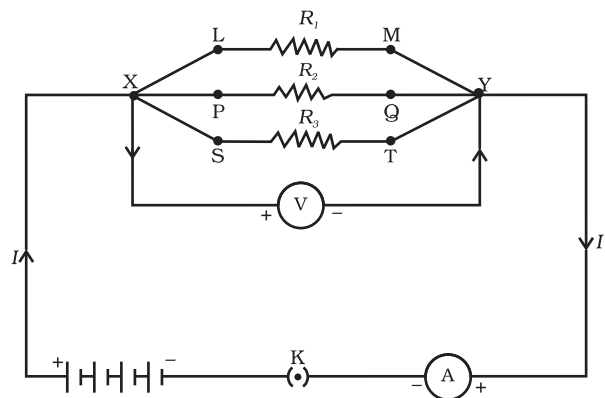

Figure 12.10

- Take out the plug from the key. Remove the ammeter and voltmeter from the circuit. Insert the ammeter in series with the resistor R_1 , as shown in Fig. 12.11. Note the ammeter reading, I_1 .

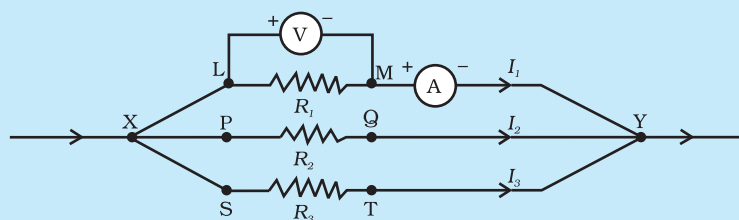

Figure 12.11

- Similarly, measure the currents through R_2 and R_3 . Let these be I_2 and I_3 , respectively. What is the relationship between I , I_1 , I_2 and I_3 ?

It is observed that the total current I , is equal to the sum of the separate currents through each branch of the combination.

$$I = I_1 + I_2 + I_3 \quad (12.15)$$

Let R_p be the equivalent resistance of the parallel combination of resistors. By applying Ohm's law to the parallel combination of resistors, we have

$$I = V/R_p \quad (12.16)$$

On applying Ohm's law to each resistor, we have

$$I_1 = V/R_1; \quad I_2 = V/R_2; \quad \text{and} \quad I_3 = V/R_3 \quad (12.17)$$

From Eqs. (12.15) to (12.17), we have

$$V/R_p = V/R_1 + V/R_2 + V/R_3$$

or

$$1/R_p = 1/R_1 + 1/R_2 + 1/R_3 \quad (12.18)$$

Thus, we may conclude that the reciprocal of the equivalent resistance of a group of resistances joined in parallel is equal to the sum of the reciprocals of the individual resistances.

Example 12.8

In the circuit diagram given in Fig. 12.10, suppose the resistors R_1 , R_2 and R_3 have the values 5Ω , 10Ω , 30Ω , respectively, which have been connected to a battery of 12 V . Calculate (a) the current through each resistor, (b) the total current in the circuit, and (c) the total circuit resistance.

Solution

$R_1 = 5 \Omega$, $R_2 = 10 \Omega$, and $R_3 = 30 \Omega$.

Potential difference across the battery, $V = 12 \text{ V}$.

This is also the potential difference across each of the individual resistor; therefore, to calculate the current in the resistors, we use Ohm's law.

$$\begin{aligned} \text{The current } I_1, \text{ through } R_1 &= V/R_1 \\ I_1 &= 12 \text{ V}/5 \Omega = 2.4 \text{ A.} \end{aligned}$$

The current I_2 , through $R_2 = V/R_2$
 $I_2 = 12 \text{ V}/10 \ \Omega = 1.2 \text{ A}.$

The current I_3 , through $R_3 = V/R_3$
 $I_3 = 12 \text{ V}/30 \ \Omega = 0.4 \text{ A}.$

The total current in the circuit,

$$\begin{aligned} I &= I_1 + I_2 + I_3 \\ &= (2.4 + 1.2 + 0.4) \text{ A} \\ &= 4 \text{ A} \end{aligned}$$

The total resistance R_p , is given by [Eq. (12.18)]

$$\frac{1}{R_p} = \frac{1}{5} + \frac{1}{10} + \frac{1}{30} = \frac{1}{3}$$

Thus, $R_p = 3 \ \Omega.$

Example 12.9

If in Fig. 12.12, $R_1 = 10 \ \Omega$, $R_2 = 40 \ \Omega$, $R_3 = 30 \ \Omega$, $R_4 = 20 \ \Omega$, $R_5 = 60 \ \Omega$, and a 12 V battery is connected to the arrangement. Calculate (a) the total resistance in the circuit, and (b) the total current flowing in the circuit.

Solution

Suppose we replace the parallel resistors R_1 and R_2 by an equivalent resistor of resistance, R' . Similarly we replace the parallel resistors R_3 , R_4 and R_5 by an equivalent single resistor of resistance R'' . Then using Eq. (12.18), we have $1/R' = 1/10 + 1/40 = 5/40$; that is $R' = 8 \ \Omega$.

Similarly, $1/R'' = 1/30 + 1/20 + 1/60 = 6/60$;
 that is, $R'' = 10 \ \Omega$.

Thus, the total resistance, $R = R' + R'' = 18 \ \Omega$.

To calculate the current, we use Ohm's law, and get

$$I = V/R = 12 \text{ V}/18 \ \Omega = 0.67 \text{ A}.$$

We have seen that in a series circuit the current is constant throughout the electric circuit. Thus it is obviously impracticable to connect an electric bulb and an electric heater in series, because they need currents of widely different values to operate properly (see Example 12.3). Another major disadvantage of a series circuit is that when one component fails the circuit is broken and none of the components works. If you have used 'fairy lights' to decorate buildings on festivals, on marriage celebrations etc., you might have seen the electrician spending lot of time in trouble-locating and replacing the 'dead' bulb – each has to be tested to find which has fused or gone. On the other hand, a parallel circuit divides the current through the electrical gadgets. The total resistance in a parallel circuit is decreased as per Eq. (12.18). This is helpful particularly when each gadget has different resistance and requires different current to operate properly.

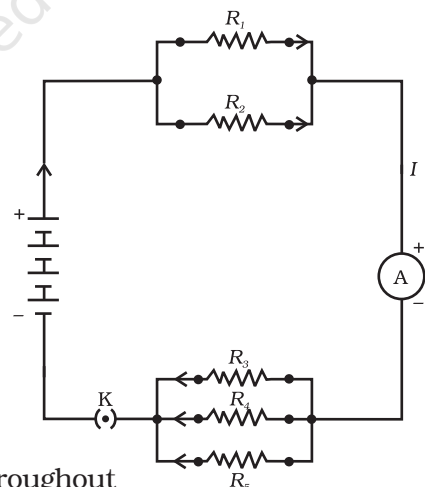

Figure 12.12
 An electric circuit showing the combination of series and parallel resistors

Q U E S T I O N S

1. Judge the equivalent resistance when the following are connected in parallel – (a) $1\ \Omega$ and $10^6\ \Omega$, (b) $1\ \Omega$ and $10^3\ \Omega$, and $10^6\ \Omega$.
2. An electric lamp of $100\ \Omega$, a toaster of resistance $50\ \Omega$, and a water filter of resistance $500\ \Omega$ are connected in parallel to a $220\ \text{V}$ source. What is the resistance of an electric iron connected to the same source that takes as much current as all three appliances, and what is the current through it?
3. What are the advantages of connecting electrical devices in parallel with the battery instead of connecting them in series?
4. How can three resistors of resistances $2\ \Omega$, $3\ \Omega$, and $6\ \Omega$ be connected to give a total resistance of (a) $4\ \Omega$, (b) $1\ \Omega$?
5. What is (a) the highest, (b) the lowest total resistance that can be secured by combinations of four coils of resistance $4\ \Omega$, $8\ \Omega$, $12\ \Omega$, $24\ \Omega$?



12.7 HEATING EFFECT OF ELECTRIC CURRENT

We know that a battery or a cell is a source of electrical energy. The chemical reaction within the cell generates the potential difference between its two terminals that sets the electrons in motion to flow the current through a resistor or a system of resistors connected to the battery. We have also seen, in Section 12.2, that to maintain the current, the source has to keep expending its energy. Where does this energy go? A part of the source energy in maintaining the current may be consumed into useful work (like in rotating the blades of an electric fan). Rest of the source energy may be expended in heat to raise the temperature of gadget. We often observe this in our everyday life. For example, an electric fan becomes warm if used continuously for longer time etc. On the other hand, if the electric circuit is purely resistive, that is, a configuration of resistors only connected to a battery; the source energy continually gets dissipated entirely in the form of heat. This is known as the heating effect of electric current. This effect is utilised in devices such as electric heater, electric iron etc.

Consider a current I flowing through a resistor of resistance R . Let the potential difference across it be V (Fig. 12.13). Let t be the time during which a charge Q flows across. The work done in moving the charge Q through a potential difference V is VQ . Therefore, the source must supply energy equal to VQ in time t . Hence the power input to the circuit by the source is

$$P = V \frac{Q}{t} = VI \quad (12.19)$$

Or the energy supplied to the circuit by the source in time t is $P \times t$, that is, $VI t$. What happens to this energy expended by the source? This energy gets dissipated in the resistor as heat. Thus for a steady current I , the amount of heat H produced in time t is

$$H = VI t \quad (12.20)$$

Applying Ohm's law [Eq. (12.5)], we get

$$H = I^2 R t \quad (12.21)$$

This is known as Joule's law of heating. The law implies that heat produced in a resistor is (i) directly proportional to the square of current for a given resistance, (ii) directly proportional to resistance for a given current, and (iii) directly proportional to the time for which the current flows through the resistor. In practical situations, when an electric appliance is connected to a known voltage source, Eq. (12.21) is used after calculating the current through it, using the relation $I = V/R$.

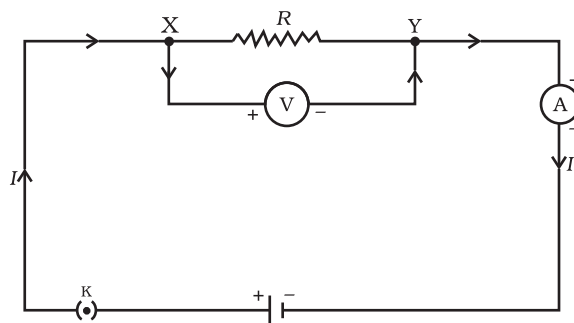

Figure 12.13
A steady current in a purely resistive electric circuit

Example 12.10

An electric iron consumes energy at a rate of 840 W when heating is at the maximum rate and 360 W when the heating is at the minimum. The voltage is 220 V. What are the current and the resistance in each case?

Solution

From Eq. (12.19), we know that the power input is

$$P = VI$$

Thus the current $I = P/V$

- (a) When heating is at the maximum rate,

$$I = 840 \text{ W}/220 \text{ V} = 3.82 \text{ A};$$

and the resistance of the electric iron is

$$R = V/I = 220 \text{ V}/3.82 \text{ A} = 57.60 \Omega.$$

- (b) When heating is at the minimum rate,

$$I = 360 \text{ W}/220 \text{ V} = 1.64 \text{ A};$$

and the resistance of the electric iron is

$$R = V/I = 220 \text{ V}/1.64 \text{ A} = 134.15 \Omega.$$

Example 12.11

100 J of heat is produced each second in a 4Ω resistance. Find the potential difference across the resistor.

Solution

$$H = 100 \text{ J}, R = 4 \Omega, t = 1 \text{ s}, V = ?$$

From Eq. (12.21) we have the current through the resistor as

$$\begin{aligned} I &= \sqrt{(H/Rt)} \\ &= \sqrt{[100 \text{ J}/(4 \Omega \times 1 \text{ s})]} \\ &= 5 \text{ A} \end{aligned}$$

Thus the potential difference across the resistor, V [from Eq. (12.5)] is

$$\begin{aligned} V &= IR \\ &= 5 \text{ A} \times 4 \Omega \\ &= 20 \text{ V}. \end{aligned}$$

Q U E S T I O N S

1. Why does the cord of an electric heater not glow while the heating element does?
2. Compute the heat generated while transferring 96000 coulomb of charge in one hour through a potential difference of 50 V.
3. An electric iron of resistance $20\ \Omega$ takes a current of 5 A. Calculate the heat developed in 30 s.



12.7.1 Practical Applications of Heating Effect of Electric Current

The generation of heat in a conductor is an inevitable consequence of electric current. In many cases, it is undesirable as it converts useful electrical energy into heat. In electric circuits, the unavoidable heating can increase the temperature of the components and alter their properties. However, heating effect of electric current has many useful applications. The electric laundry iron, electric toaster, electric oven, electric kettle and electric heater are some of the familiar devices based on Joule's heating.

The electric heating is also used to produce light, as in an electric bulb. Here, the filament must retain as much of the heat generated as is possible, so that it gets very hot and emits light. It must not melt at such high temperature. A strong metal with high melting point such as tungsten (melting point 3380°C) is used for making bulb filaments. The filament should be thermally isolated as much as possible, using insulating support, etc. The bulbs are usually filled with chemically inactive nitrogen and argon gases to prolong the life of filament. Most of the power consumed by the filament appears as heat, but a small part of it is in the form of light radiated.

Another common application of Joule's heating is the fuse used in electric circuits. It protects circuits and appliances by stopping the flow of any unduly high electric current. The fuse is placed in series with the device. It consists of a piece of wire made of a metal or an alloy of appropriate melting point, for example aluminium, copper, iron, lead etc. If a current larger than the specified value flows through the circuit, the temperature of the fuse wire increases. This melts the fuse wire and breaks the circuit. The fuse wire is usually encased in a cartridge of porcelain or similar material with metal ends. The fuses used for domestic purposes are rated as 1 A, 2 A, 3 A, 5 A, 10 A, etc. For an electric iron which consumes 1 kW electric power when operated at 220 V, a current of $(1000/220)$ A, that is, 4.54 A will flow in the circuit. In this case, a 5 A fuse must be used.

12.8 ELECTRIC POWER

You have studied in your earlier Class that the rate of doing work is power. This is also the rate of consumption of energy.

Equation (12.21) gives the rate at which electric energy is dissipated or consumed in an electric circuit. This is also termed as electric power. The power P is given by

$$P = VI$$

Or $P = I^2R = V^2/R$ (12.22)

The SI unit of electric power is watt (W). It is the power consumed by a device that carries 1 A of current when operated at a potential difference of 1 V. Thus,

$$1 \text{ W} = 1 \text{ volt} \times 1 \text{ ampere} = 1 \text{ V A} \quad (12.23)$$

The unit 'watt' is very small. Therefore, in actual practice we use a much larger unit called 'kilowatt'. It is equal to 1000 watts. Since electrical energy is the product of power and time, the unit of electric energy is, therefore, watt hour (W h). One watt hour is the energy consumed when 1 watt of power is used for 1 hour. The commercial unit of electric energy is kilowatt hour (kW h), commonly known as 'unit'.

$$\begin{aligned} 1 \text{ kW h} &= 1000 \text{ watt} \times 3600 \text{ second} \\ &= 3.6 \times 10^6 \text{ watt second} \\ &= 3.6 \times 10^6 \text{ joule (J)} \end{aligned}$$

More to Know!

Many people think that electrons are consumed in an electric circuit. This is wrong! We pay the electricity board or electric company to provide energy to move electrons through the electric gadgets like electric bulb, fan and engines. We pay for the energy that we use.

Example 12.12

An electric bulb is connected to a 220 V generator. The current is 0.50 A. What is the power of the bulb?

Solution

$$\begin{aligned} P &= VI \\ &= 220 \text{ V} \times 0.50 \text{ A} \\ &= 110 \text{ J/s} \\ &= 110 \text{ W.} \end{aligned}$$

Example 12.13

An electric refrigerator rated 400 W operates 8 hour/day. What is the cost of the energy to operate it for 30 days at Rs 3.00 per kW h?

Solution

The total energy consumed by the refrigerator in 30 days would be
 $400 \text{ W} \times 8.0 \text{ hour/day} \times 30 \text{ days} = 96000 \text{ W h}$
 $= 96 \text{ kW h}$

Thus the cost of energy to operate the refrigerator for 30 days is
 $96 \text{ kW h} \times \text{Rs } 3.00 \text{ per kW h} = \text{Rs } 288.00$

Q U E S T I O N S

1. What determines the rate at which energy is delivered by a current?
2. An electric motor takes 5 A from a 220 V line. Determine the power of the motor and the energy consumed in 2 h.



What you have learnt

- A stream of electrons moving through a conductor constitutes an electric current. Conventionally, the direction of current is taken opposite to the direction of flow of electrons.
- The SI unit of electric current is ampere.
- To set the electrons in motion in an electric circuit, we use a cell or a battery. A cell generates a potential difference across its terminals. It is measured in volts (V).
- Resistance is a property that resists the flow of electrons in a conductor. It controls the magnitude of the current. The SI unit of resistance is ohm (Ω).
- Ohm's law: The potential difference across the ends of a resistor is directly proportional to the current through it, provided its temperature remains the same.
- The resistance of a conductor depends directly on its length, inversely on its area of cross-section, and also on the material of the conductor.
- The equivalent resistance of several resistors in series is equal to the sum of their individual resistances.
- A set of resistors connected in parallel has an equivalent resistance R_p given by

$$\frac{1}{R_p} = \frac{1}{R_1} + \frac{1}{R_2} + \frac{1}{R_3} + \dots$$

- The electrical energy dissipated in a resistor is given by
 $W = V \times I \times t$
- The unit of power is watt (W). One watt of power is consumed when 1 A of current flows at a potential difference of 1 V.
- The commercial unit of electrical energy is kilowatt hour (kWh).
 $1 \text{ kW h} = 3,600,000 \text{ J} = 3.6 \times 10^6 \text{ J}$.

E X E R C I S E S

1. A piece of wire of resistance R is cut into five equal parts. These parts are then connected in parallel. If the equivalent resistance of this combination is R' , then the ratio R/R' is –

(a) $1/25$	(b) $1/5$	(c) 5	(d) 25
------------	-----------	---------	----------
2. Which of the following terms does not represent electrical power in a circuit?

(a) I^2R	(b) IR^2	(c) VI	(d) V^2/R
------------	------------	----------	-------------
3. An electric bulb is rated 220 V and 100 W. When it is operated on 110 V, the power consumed will be –

(a) 100 W	(b) 75 W	(c) 50 W	(d) 25 W
-----------	----------	----------	----------
4. Two conducting wires of the same material and of equal lengths and equal diameters are first connected in series and then parallel in a circuit across the same potential difference. The ratio of heat produced in series and parallel combinations would be –

(a) 1:2	(b) 2:1	(c) 1:4	(d) 4:1
---------	---------	---------	---------
5. How is a voltmeter connected in the circuit to measure the potential difference between two points?
6. A copper wire has diameter 0.5 mm and resistivity of $1.6 \times 10^{-8} \Omega \text{ m}$. What will be the length of this wire to make its resistance 10 Ω ? How much does the resistance change if the diameter is doubled?
7. The values of current I flowing in a given resistor for the corresponding values of potential difference V across the resistor are given below –

I (amperes)	0.5	1.0	2.0	3.0	4.0
V (volts)	1.6	3.4	6.7	10.2	13.2

Plot a graph between V and I and calculate the resistance of that resistor.
8. When a 12 V battery is connected across an unknown resistor, there is a current of 2.5 mA in the circuit. Find the value of the resistance of the resistor.
9. A battery of 9 V is connected in series with resistors of 0.2 Ω , 0.3 Ω , 0.4 Ω , 0.5 Ω and 12 Ω , respectively. How much current would flow through the 12 Ω resistor?
10. How many 176 Ω resistors (in parallel) are required to carry 5 A on a 220 V line?
11. Show how you would connect three resistors, each of resistance 6 Ω , so that the combination has a resistance of (i) 9 Ω , (ii) 4 Ω .
12. Several electric bulbs designed to be used on a 220 V electric supply line, are rated 10 W. How many lamps can be connected in parallel with each other across the two wires of 220 V line if the maximum allowable current is 5 A?
13. A hot plate of an electric oven connected to a 220 V line has two resistance coils A and B, each of 24 Ω resistance, which may be used separately, in series, or in parallel. What are the currents in the three cases?
14. Compare the power used in the 2 Ω resistor in each of the following circuits: (i) a 6 V battery in series with 1 Ω and 2 Ω resistors, and (ii) a 4 V battery in parallel with 12 Ω and 2 Ω resistors.

15. Two lamps, one rated 100 W at 220 V, and the other 60 W at 220 V, are connected in parallel to electric mains supply. What current is drawn from the line if the supply voltage is 220 V?
16. Which uses more energy, a 250 W TV set in 1 hr, or a 1200 W toaster in 10 minutes?
17. An electric heater of resistance $8\ \Omega$ draws 15 A from the service mains 2 hours. Calculate the rate at which heat is developed in the heater.
18. Explain the following.
 - (a) Why is the tungsten used almost exclusively for filament of electric lamps?
 - (b) Why are the conductors of electric heating devices, such as bread-toasters and electric irons, made of an alloy rather than a pure metal?
 - (c) Why is the series arrangement not used for domestic circuits?
 - (d) How does the resistance of a wire vary with its area of cross-section?
 - (e) Why are copper and aluminium wires usually employed for electricity transmission?

© NCERT
not to be republished

CHAPTER 13

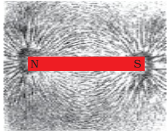

Magnetic Effects of Electric Current



1064CH13

In the previous Chapter on 'Electricity' we learnt about the heating effects of electric current. What could be the other effects of electric current? We know that an electric current-carrying wire behaves like a magnet. Let us perform the following Activity to reinforce it.

Activity 13.1

- Take a straight thick copper wire and place it between the points X and Y in an electric circuit, as shown in Fig. 13.1. The wire XY is kept perpendicular to the plane of paper.
- Horizontally place a small compass near to this copper wire. See the position of its needle.
- Pass the current through the circuit by inserting the key into the plug.
- Observe the change in the position of the compass needle.

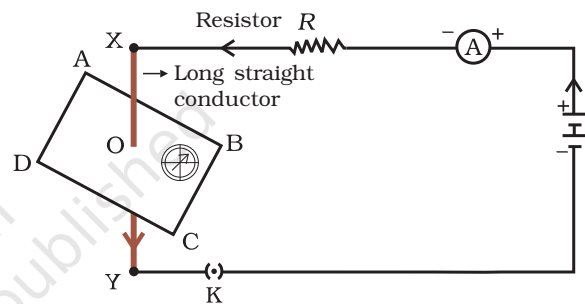

Figure 13.1

Compass needle is deflected on passing an electric current through a metallic conductor

We see that the needle is deflected. What does it mean? It means that the electric current through the copper wire has produced a magnetic effect. Thus we can say that electricity and magnetism are linked to each other. Then, what about the reverse possibility of an electric effect of moving magnets? In this Chapter we will study magnetic fields and such electromagnetic effects. We shall also study about electromagnets and electric motors which involve the magnetic effect of electric current, and electric generators which involve the electric effect of moving magnets.

Hans Christian Oersted (1777–1851)

Hans Christian Oersted, one of the leading scientists of the 19th century, played a crucial role in understanding *electromagnetism*. In 1820 he accidentally discovered that a compass needle got deflected when an electric current passed through a metallic wire placed nearby. Through this observation Oersted showed that electricity and magnetism were related phenomena. His research later created technologies such as the radio, television and fiber optics. The unit of magnetic field strength is named the oersted in his honor.



13.1 MAGNETIC FIELD AND FIELD LINES

We are familiar with the fact that a compass needle gets deflected when brought near a bar magnet. A compass needle is, in fact, a small bar magnet. The ends of the compass needle point approximately towards north and south directions. The end pointing towards north is called *north seeking* or north pole. The other end that points towards south is called *south seeking* or south pole. Through various activities we have observed that like poles repel, while unlike poles of magnets attract each other.

Q U E S T I O N

1. Why does a compass needle get deflected when brought near a bar magnet?



Activity 13.2

- Fix a sheet of white paper on a drawing board using some adhesive material.
- Place a bar magnet in the centre of it.
- Sprinkle some iron filings uniformly around the bar magnet (Fig. 13.2). A salt-sprinkler may be used for this purpose.
- Now tap the board gently.
- What do you observe?

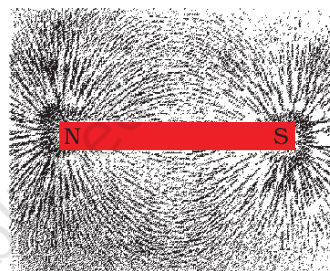

Figure 13.2

Iron filings near the bar magnet align themselves along the field lines.

The iron filings arrange themselves in a pattern as shown Fig. 13.2. Why do the iron filings arrange in such a pattern? What does this pattern demonstrate? The magnet exerts its influence in the region surrounding it. Therefore the iron filings experience a force. The force thus exerted makes iron filings to arrange in a pattern. The region surrounding a magnet, in which the force of the magnet can be detected, is said to have a magnetic field. The lines along which the iron filings align themselves represent magnetic field lines.

Are there other ways of obtaining magnetic field lines around a bar magnet? Yes, you can yourself draw the field lines of a bar magnet.

Activity 13.3

- Take a small compass and a bar magnet.
- Place the magnet on a sheet of white paper fixed on a drawing board, using some adhesive material.
- Mark the boundary of the magnet.
- Place the compass near the north pole of the magnet. How does it behave? The south pole of the needle points towards the north pole of the magnet. The north pole of the compass is directed away from the north pole of the magnet.

- Mark the position of two ends of the needle.
- Now move the needle to a new position such that its south pole occupies the position previously occupied by its north pole.
- In this way, proceed step by step till you reach the south pole of the magnet as shown in Fig. 13.3.
- Join the points marked on the paper by a smooth curve. This curve represents a field line.
- Repeat the above procedure and draw as many lines as you can. You will get a pattern shown in Fig. 13.4. These lines represent the magnetic field around the magnet. These are known as magnetic field lines.
- Observe the deflection in the compass needle as you move it along a field line. The deflection increases as the needle is moved towards the poles.

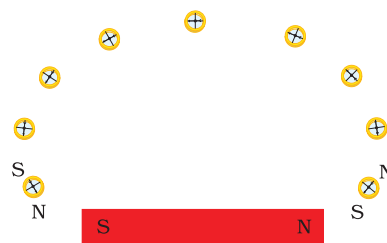

Figure 13.3

Drawing a magnetic field line with the help of a compass needle

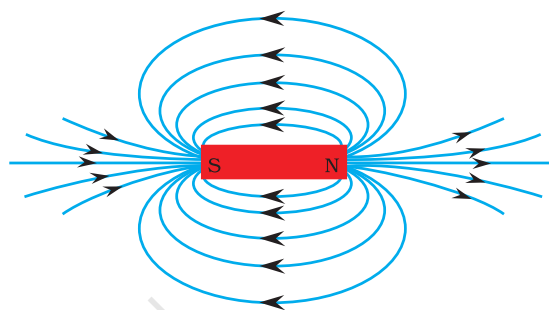

Figure 13.4

Field lines around a bar magnet

Magnetic field is a quantity that has both direction and magnitude. The direction of the magnetic field is taken to be the direction in which a north pole of the compass needle moves inside it. Therefore it is taken by convention that the field lines emerge from north pole and merge at the south pole (note the arrows marked on the field lines in Fig. 13.4). Inside the magnet, the direction of field lines is from its south pole to its north pole. Thus the magnetic field lines are closed curves.

The relative strength of the magnetic field is shown by the degree of closeness of the field lines. The field is stronger, that is, the force acting on the pole of another magnet placed is greater where the field lines are crowded (see Fig. 13.4).

No two field-lines are found to cross each other. If they did, it would mean that at the point of intersection, the compass needle would point towards two directions, which is not possible.

13.2 MAGNETIC FIELD DUE TO A CURRENT-CARRYING CONDUCTOR

In Activity 13.1, we have seen that an electric current through a metallic conductor produces a magnetic field around it. In order to find the direction of the field produced let us repeat the activity in the following way –

Activity 13.4

- Take a long straight copper wire, two or three cells of 1.5 V each, and a plug key. Connect all of them in series as shown in Fig. 13.5 (a).
- Place the straight wire parallel to and over a compass needle.
- Plug the key in the circuit.
- Observe the direction of deflection of the north pole of the needle. If the current flows from north to south, as shown in Fig. 13.5 (a), the north pole of the compass needle would move towards the east.
- Replace the cell connections in the circuit as shown in Fig. 13.5 (b). This would result in the change of the direction of current through the copper wire, that is, from south to north.
- Observe the change in the direction of deflection of the needle. You will see that now the needle moves in opposite direction, that is, towards the west [Fig. 13.5 (b)]. It means that the direction of magnetic field produced by the electric current is also reversed.

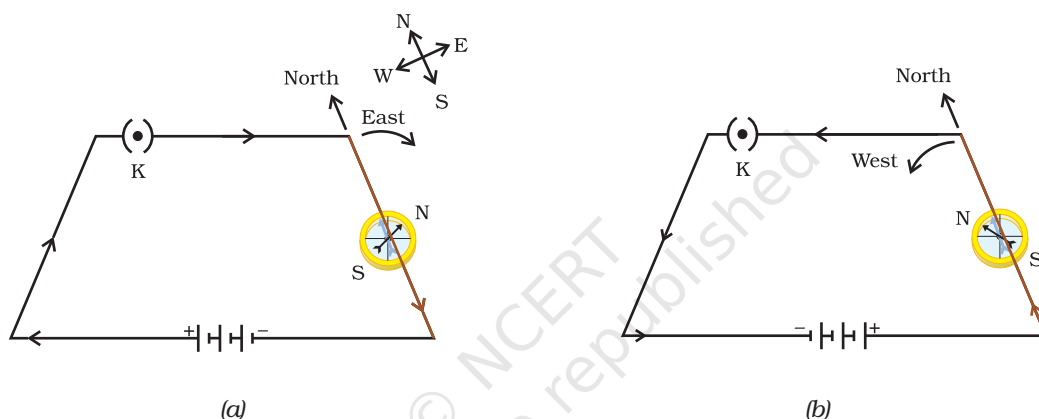

Figure 13.5 A simple electric circuit in which a straight copper wire is placed parallel to and over a compass needle. The deflection in the needle becomes opposite when the direction of the current is reversed.

13.2.1 Magnetic Field due to a Current through a Straight Conductor

What determines the pattern of the magnetic field generated by a current through a conductor? Does the pattern depend on the shape of the conductor? We shall investigate this with an activity.

We shall first consider the pattern of the magnetic field around a straight conductor carrying current.

Activity 13.5

- Take a battery (12 V), a variable resistance (or a rheostat), an ammeter (0–5 A), a plug key, connecting wires and a long straight thick copper wire.
- Insert the thick wire through the centre, normal to the plane of a rectangular cardboard. Take care that the cardboard is fixed and does not slide up or down.

- Connect the copper wire vertically between the points X and Y, as shown in Fig. 13.6 (a), in series with the battery, a plug and key.
- Sprinkle some iron filings uniformly on the cardboard. (You may use a salt sprinkler for this purpose.)
- Keep the variable of the rheostat at a fixed position and note the current through the ammeter.
- Close the key so that a current flows through the wire. Ensure that the copper wire placed between the points X and Y remains vertically straight.
- Gently tap the cardboard a few times. Observe the pattern of the iron filings. You would find that the iron filings align themselves showing a pattern of concentric circles around the copper wire (Fig. 13.6).
- What do these concentric circles represent? They represent the magnetic field lines.
- How can the direction of the magnetic field be found? Place a compass at a point (say P) over a circle. Observe the direction of the needle. The direction of the north pole of the compass needle would give the direction of the field lines produced by the electric current through the straight wire at point P. Show the direction by an arrow.
- Does the direction of magnetic field lines get reversed if the direction of current through the straight copper wire is reversed? Check it.

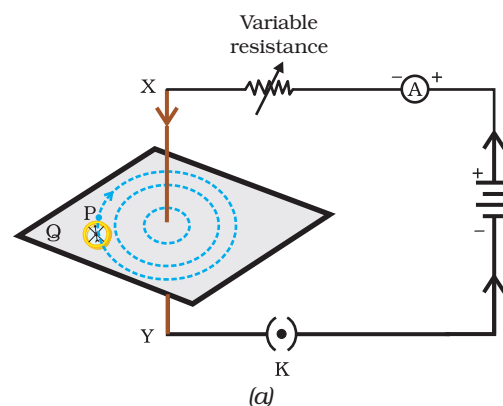

Figure 13.6

- (a) A pattern of concentric circles indicating the field lines of a magnetic field around a straight conducting wire. The arrows in the circles show the direction of the field lines.
 (b) A close up of the pattern obtained.

What happens to the deflection of the compass needle placed at a given point if the current in the copper wire is changed? To see this, vary the current in the wire. We find that the deflection in the needle also changes. In fact, if the current is increased, the deflection also increases. It indicates that the magnitude of the magnetic field produced at a given point increases as the current through the wire increases.

What happens to the deflection of the needle if the compass is moved away from the copper wire but the current through the wire remains the same? To see this, now place the compass at a farther point from the conducting wire (say at point Q). What change do you observe? We see that the deflection in the needle decreases. Thus the magnetic field produced by a given current in the conductor decreases as the distance from it increases. From Fig. 13.6, it can be noticed that the concentric circles representing the magnetic field around a current-carrying straight wire become larger and larger as we move away from it.

13.2.2 Right-Hand Thumb Rule

A convenient way of finding the direction of magnetic field associated with a current-carrying conductor is given in Fig. 13.7.

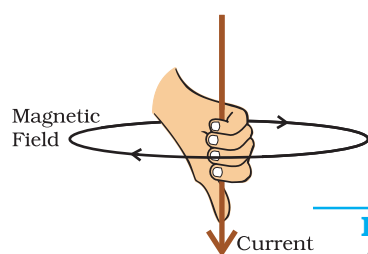

Figure 13.7
Right-hand thumb rule

Imagine that you are holding a current-carrying straight conductor in your right hand such that the thumb points towards the direction of current. Then your fingers will wrap around the conductor in the direction of the field lines of the magnetic field, as shown in Fig. 13.7. This is known as the right-hand thumb rule*.

Example 13.1

A current through a horizontal power line flows in east to west direction. What is the direction of magnetic field at a point directly below it and at a point directly above it?

Solution

The current is in the east-west direction. Applying the right-hand thumb rule, we get that the magnetic field (at any point below or above the wire) turns clockwise in a plane perpendicular to the wire, when viewed from the east end, and anti-clockwise, when viewed from the west end.

Q U E S T I O N S

1. Draw magnetic field lines around a bar magnet.
2. List the properties of magnetic field lines.
3. Why don't two magnetic field lines intersect each other?



13.2.3 Magnetic Field due to a Current through a Circular Loop

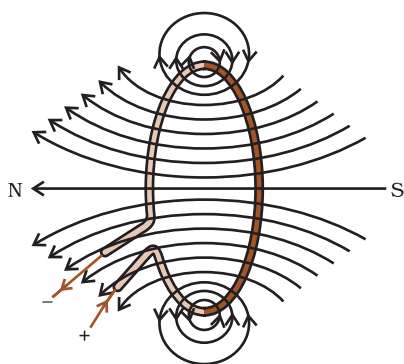

Figure 13.8
Magnetic field lines of the field produced by a current-carrying circular loop

We have so far observed the pattern of the magnetic field lines produced around a current-carrying straight wire. Suppose this straight wire is bent in the form of a circular loop and a current is passed through it. How would the magnetic field lines look like? We know that the magnetic field produced by a current-carrying straight wire depends inversely on the distance from it. Similarly at every point of a current-carrying circular loop, the concentric circles representing the magnetic field around it would become larger and larger as we move away from the wire (Fig. 13.8). By the time we reach at the centre of the circular loop, the arcs of these *big* circles would appear as straight lines. Every point on the wire carrying current would give rise to the magnetic field appearing as straight lines at the center of the loop. By applying the right hand rule, it is easy to check that every section of the wire contributes to the magnetic field lines in the same direction within the loop.

* This rule is also called Maxwell's corkscrew rule. If we consider ourselves driving a corkscrew in the direction of the current, then the direction of the rotation of corkscrew is the direction of the magnetic field.

We know that the magnetic field produced by a current-carrying wire at a given point depends directly on the current passing through it. Therefore, if there is a circular coil having n turns, the field produced is n times as large as that produced by a single turn. This is because the current in each circular turn has the same direction, and the field due to each turn then just adds up.

Activity 13.6

- Take a rectangular cardboard having two holes. Insert a circular coil having large number of turns through them, normal to the plane of the cardboard.
- Connect the ends of the coil in series with a battery, a key and a rheostat, as shown in Fig. 13.9.
- Sprinkle iron filings uniformly on the cardboard.
- Plug the key.
- Tap the cardboard gently a few times. Note the pattern of the iron filings that emerges on the cardboard.

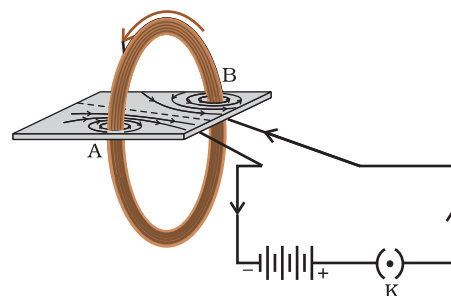

Figure 13.9
Magnetic field produced by a current-carrying circular coil.

13.2.4 Magnetic Field due to a Current in a Solenoid

A coil of many circular turns of insulated copper wire wrapped closely in the shape of a cylinder is called a solenoid. The pattern of the magnetic field lines around a current-carrying solenoid is shown in Fig. 13.10. Compare the pattern of the field with the magnetic field around a bar magnet (Fig. 13.4). Do they look similar? Yes, they are similar. In fact, one end of the solenoid behaves as a magnetic north pole, while the other behaves as the south pole. The field lines inside the solenoid are in the form of parallel straight lines. This indicates that the magnetic field is the same at all points inside the solenoid. That is, the field is uniform inside the solenoid.

A strong magnetic field produced inside a solenoid can be used to magnetise a piece of magnetic material, like soft iron, when placed inside the coil (Fig. 13.11). The magnet so formed is called an electromagnet.

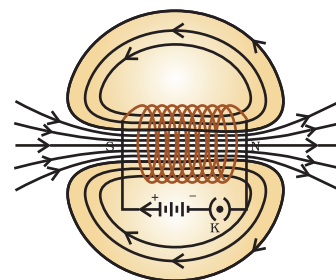

Figure 13.10
Field lines of the magnetic field through and around a current-carrying solenoid.

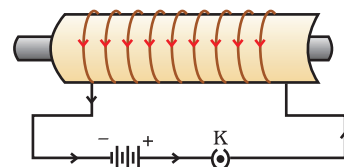

Figure 13.11
A current-carrying solenoid coil is used to magnetise steel rod inside it – an electromagnet.

Q U E S T I O N S

1. Consider a circular loop of wire lying in the plane of the table. Let the current pass through the loop clockwise. Apply the right-hand rule to find out the direction of the magnetic field inside and outside the loop.
2. The magnetic field in a given region is uniform. Draw a diagram to represent it.



3. Choose the correct option.

The magnetic field inside a long straight solenoid-carrying current

- (a) is zero.
- (b) decreases as we move towards its end.
- (c) increases as we move towards its end.
- (d) is the same at all points.

13.3 FORCE ON A CURRENT-CARRYING CONDUCTOR IN A MAGNETIC FIELD

We have learnt that an electric current flowing through a conductor produces a magnetic field. The field so produced exerts a force on a magnet placed in the vicinity of the conductor. French scientist Andre Marie Ampere (1775–1836) suggested that the magnet must also exert an equal and opposite force on the current-carrying conductor. The force due to a magnetic field acting on a current-carrying conductor can be demonstrated through the following activity.

Activity 13.7

- Take a small aluminium rod AB (of about 5 cm). Using two connecting wires suspend it horizontally from a stand, as shown in Fig. 13.12.
- Place a strong horse-shoe magnet in such a way that the rod lies between the two poles with the magnetic field directed upwards. For this put the north pole of the magnet vertically below and south pole vertically above the aluminium rod (Fig. 13.12).
- Connect the aluminium rod in series with a battery, a key and a rheostat.
- Now pass a current through the aluminium rod from end B to end A.
- What do you observe? It is observed that the rod is displaced towards the left. You will notice that the rod gets displaced.
- Reverse the direction of current flowing through the rod and observe the direction of its displacement. It is now towards the right.
Why does the rod get displaced?

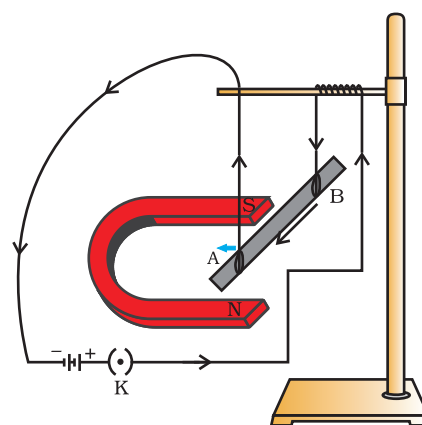

Figure 13.12

A current-carrying rod, AB, experiences a force perpendicular to its length and the magnetic field. Support for the magnet is not shown here, for simplicity.

The displacement of the rod in the above activity suggests that a force is exerted on the current-carrying aluminium rod when it is placed in a magnetic field. It also suggests that the direction of force is also reversed when the direction of current through the conductor is reversed. Now change the direction of field to vertically downwards by interchanging the two poles of the magnet. It is once again observed that

the direction of force acting on the current-carrying rod gets reversed. It shows that the direction of the force on the conductor depends upon the direction of current and the direction of the magnetic field. Experiments have shown that the displacement of the rod is largest (or the magnitude of the force is the highest) when the direction of current is at right angles to the direction of the magnetic field. In such a condition we can use a simple rule to find the direction of the force on the conductor.

In Activity 13.7, we considered the direction of the current and that of the magnetic field perpendicular to each other and found that the force is perpendicular to both of them. The three directions can be illustrated through a simple rule, called Fleming's left-hand rule. According to this rule, stretch the thumb, forefinger and middle finger of your left hand such that they are mutually perpendicular (Fig. 13.13). If the first finger points in the direction of magnetic field and the second finger in the direction of current, then the thumb will point in the direction of motion or the force acting on the conductor.

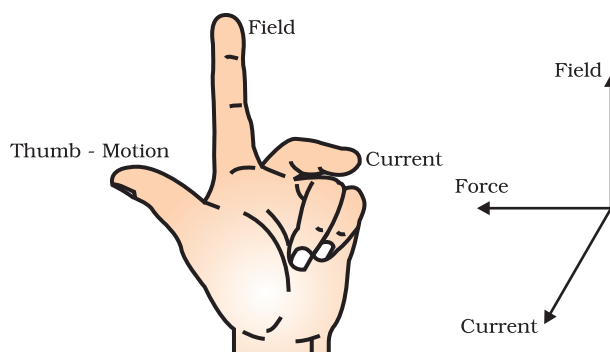

Figure 13.13
Fleming's left-hand rule

Devices that use current-carrying conductors and magnetic fields include electric motor, electric generator, loudspeakers, microphones and measuring instruments. In the next few sections we shall study about electric motors and generators.

Example 13.2

An electron enters a magnetic field at right angles to it, as shown in Fig. 13.14. The direction of force acting on the electron will be

- to the right.
- to the left.
- out of the page.
- into the page.

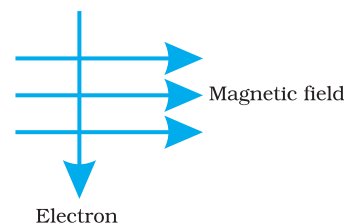

Figure 13.14

Solution

Answer is option (d). The direction of force is perpendicular to the direction of magnetic field and current as given by Fleming's left hand rule. Recall that the direction of current is taken opposite to the direction of motion of electrons. The force is therefore directed into the page.

Q U E S T I O N S

- Which of the following property of a proton can change while it moves freely in a magnetic field? (There may be more than one correct answer.)

(a) mass	(b) speed
(c) velocity	(d) momentum



- In Activity 13.7, how do we think the displacement of rod AB will be affected if (i) current in rod AB is increased; (ii) a stronger horse-shoe magnet is used; and (iii) length of the rod AB is increased?
- A positively-charged particle (alpha-particle) projected towards west is deflected towards north by a magnetic field. The direction of magnetic field is

(a) towards south	(b) towards east
(c) downward	(d) upward

More to Know!

Magnetism in medicine

An electric current always produces a magnetic field. Even weak ion currents that travel along the nerve cells in our body produce magnetic fields. When we touch something, our nerves carry an electric impulse to the muscles we need to use. This impulse produces a temporary magnetic field. These fields are very weak and are about one-billionth of the earth's magnetic field. Two main organs in the human body where the magnetic field produced is significant, are the heart and the brain. The magnetic field inside the body forms the basis of obtaining the images of different body parts. This is done using a technique called Magnetic Resonance Imaging (MRI). Analysis of these images helps in medical diagnosis. Magnetism has, thus, got important uses in medicine.

13.4 ELECTRIC MOTOR

An electric motor is a rotating device that converts electrical energy to mechanical energy. Electric motor is used as an important component in electric fans, refrigerators, mixers, washing machines, computers, MP3 players etc. Do you know how an electric motor works?

An electric motor, as shown in Fig. 13.15, consists of a rectangular coil ABCD of insulated copper wire. The coil is placed between the two poles of a magnetic field such that the arm AB and CD are perpendicular to the direction of the magnetic field. The ends of the coil are connected to the two halves P and Q of a split ring. The inner sides of these halves are insulated and attached to an axle. The external conducting edges of P and Q touch two conducting stationary brushes X and Y, respectively, as shown in the Fig. 13.15.

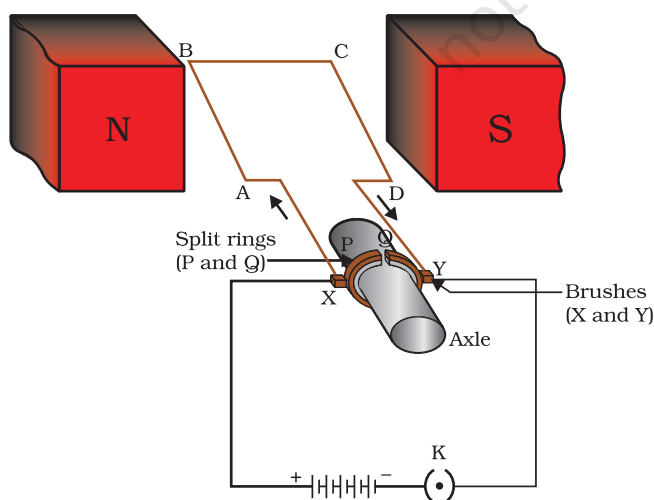

Figure 13.15
A simple electric motor

The ends of the coil are connected to the two halves P and Q of a split ring. The inner sides of these halves are insulated and attached to an axle. The external conducting edges of P and Q touch two conducting stationary brushes X and Y, respectively, as shown in the Fig. 13.15.

Current in the coil ABCD enters from the source battery through conducting brush X and flows back to the battery through brush Y. Notice that the current in arm AB of the coil flows from A to B. In arm CD it flows from C to D, that is, opposite to the direction of current through arm AB. On applying Fleming's left hand rule for the direction of force on a current-carrying

conductor in a magnetic field (see Fig. 13.13). We find that the force acting on arm AB pushes it downwards while the force acting on arm CD pushes it upwards. Thus the coil and the axle O, mounted free to turn about an axis, rotate anti-clockwise. At half rotation, Q makes contact with the brush X and P with brush Y. Therefore the current in the coil gets reversed and flows along the path DCBA. A device that reverses the direction of flow of current through a circuit is called a commutator. In electric motors, the split ring acts as a commutator. The reversal of current also reverses the direction of force acting on the two arms AB and CD. Thus the arm AB of the coil that was earlier pushed down is now pushed up and the arm CD previously pushed up is now pushed down. Therefore the coil and the axle rotate half a turn more in the same direction. The reversing of the current is repeated at each half rotation, giving rise to a continuous rotation of the coil and to the axle.

The commercial motors use (i) an electromagnet in place of permanent magnet; (ii) large number of turns of the conducting wire in the current-carrying coil; and (iii) a soft iron core on which the coil is wound. The soft iron core, on which the coil is wound, plus the coils, is called an armature. This enhances the power of the motor.

Q U E S T I O N S

1. State Fleming's left-hand rule.
2. What is the principle of an electric motor?
3. What is the role of the split ring in an electric motor?



13.5 ELECTROMAGNETIC INDUCTION

We have studied that when a current-carrying conductor is placed in a magnetic field such that the direction of current is perpendicular to the magnetic field, it experiences a force. This force causes the conductor to move. Now let us imagine a situation in which a conductor is moving inside a magnetic field or a magnetic field is changing around a fixed conductor. What will happen? This was first studied by English physicist Michael Faraday. In 1831, Faraday made an important breakthrough by discovering how a moving magnet can be used to generate electric currents. To observe this effect, let us perform the following activity.

Activity 13.8

- Take a coil of wire AB having a large number of turns.
- Connect the ends of the coil to a galvanometer as shown in Fig. 13.16.
- Take a strong bar magnet and move its north pole towards the end B of the coil. Do you find any change in the galvanometer needle?

- There is a momentary deflection in the needle of the galvanometer, say to the right. This indicates the presence of a current in the coil AB. The deflection becomes zero the moment the motion of the magnet stops.
- Now withdraw the north pole of the magnet away from the coil. Now the galvanometer is deflected toward the left, showing that the current is now set up in the direction opposite to the first.
- Place the magnet stationary at a point near to the coil, keeping its north pole towards the end B of the coil. We see that the galvanometer needle deflects toward the right when the coil is moved towards the north pole of the magnet. Similarly the needle moves toward left when the coil is moved away.
- When the coil is kept stationary with respect to the magnet, the deflection of the galvanometer drops to zero. What do you conclude from this activity?

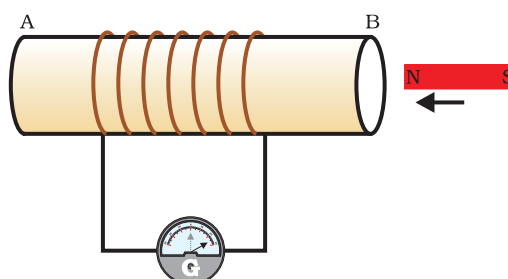
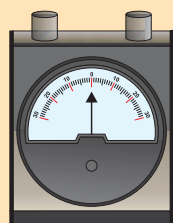

Figure 13.16
Moving a magnet towards a coil sets up a current in the coil circuit, as indicated by deflection in the galvanometer needle.



A galvanometer is an instrument that can detect the presence of a current in a circuit. The pointer remains at zero (the centre of the scale) for zero current flowing through it. It can deflect either to the left or to the right of the zero mark depending on the direction of current.

You can also check that if you had moved south pole of the magnet towards the end B of the coil, the deflections in the galvanometer would just be opposite to the previous case. When the coil and the magnet are both stationary, there is no deflection in the galvanometer. It is, thus, clear from this activity that motion of a magnet with respect to the coil produces an induced potential difference, which sets up an induced electric current in the circuit.

Michael Faraday (1791–1867)



Michael Faraday was an experimental physicist. He had no formal education. He worked in a book-binding shop during his early years. He used to read books that came for binding. This way Faraday developed his interest in science. He got an opportunity to listen to some public lectures by Humphrey Davy of Royal Institute. He made careful notes of Davy's lectures and sent them to Davy. Soon he was made an assistant in Davy's laboratory at the Royal Institute. Faraday made several path-breaking discoveries that include electromagnetic induction and the laws of electrolysis. Several universities conferred

on him the honorary degrees but he turned down such honours. Faraday loved his science work more than any honour.

Let us now perform a variation of Activity 13.8 in which the moving magnet is replaced by a current-carrying coil and the current in the coil can be varied.

Activity 13.9

- Take two different coils of copper wire having large number of turns (say 50 and 100 turns respectively). Insert them over a non-conducting cylindrical roll, as shown in Fig. 13.17. (You may use a thick paper roll for this purpose.)
- Connect the coil-1, having larger number of turns, in series with a battery and a plug key. Also connect the other coil-2 with a galvanometer as shown.
- Plug in the key. Observe the galvanometer. Is there a deflection in its needle? You will observe that the needle of the galvanometer instantly jumps to one side and just as quickly returns to zero, indicating a momentary current in coil-2.
- Disconnect coil-1 from the battery. You will observe that the needle momentarily moves, but to the opposite side. It means that now the current flows in the opposite direction in coil-2.

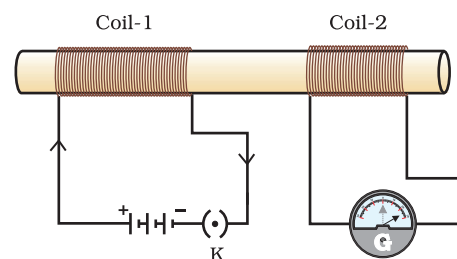

Figure 13.17
Current is induced in coil-2 when current in coil-1 is changed

In this activity we observe that as soon as the current in coil-1 reaches either a steady value or zero, the galvanometer in coil-2 shows no deflection.

From these observations, we conclude that a potential difference is induced in the coil-2 whenever the electric current through the coil-1 is changing (starting or stopping). Coil-1 is called the primary coil and coil-2 is called the secondary coil. As the current in the first coil changes, the magnetic field associated with it also changes. Thus the magnetic field lines around the secondary coil also change. Hence the change in magnetic field lines associated with the secondary coil is the cause of induced electric current in it. This process, by which a changing magnetic field in a conductor induces a current in another conductor, is called electromagnetic induction. In practice we can induce current in a coil either by moving it in a magnetic field or by changing the magnetic field around it. It is convenient in most situations to move the coil in a magnetic field.

The induced current is found to be the highest when the direction of motion of the coil is at right angles to the magnetic field. In this situation, we can use a simple rule to know the direction of the induced current. Stretch the thumb, forefinger and middle finger of right hand so that they are perpendicular to each other, as shown in Fig. 13.18. If the forefinger indicates the direction of the magnetic field and the thumb shows the direction of motion of conductor, then the middle finger will show the direction of induced current. This simple rule is called Fleming's right-hand rule.

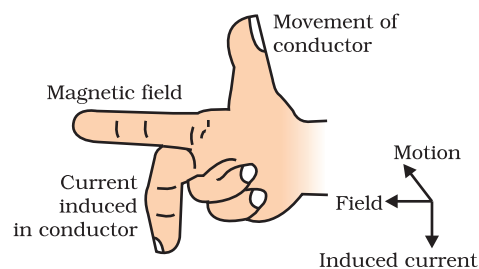

Figure 13.18
Fleming's right-hand rule

Q U E S T I O N

1. Explain different ways to induce current in a coil.



13.6 ELECTRIC GENERATOR

Based on the phenomenon of electromagnetic induction, the experiments studied above generate induced current, which is usually very small. This principle is also employed to produce large currents for use in homes and industry. In an electric generator, mechanical energy is used to rotate a conductor in a magnetic field to produce electricity.

An electric generator, as shown in Fig. 13.19, consists of a rotating rectangular coil ABCD placed between the two poles of a permanent magnet.

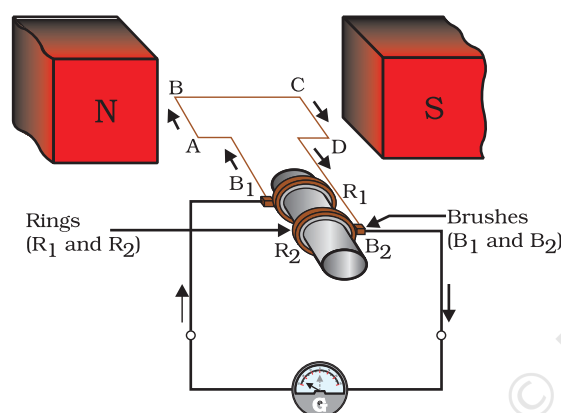

Figure 13.19
Illustration of the principle of electric generator

The two ends of this coil are connected to the two rings R_1 and R_2 . The inner side of these rings are made insulated. The two conducting stationary brushes B_1 and B_2 are kept pressed separately on the rings R_1 and R_2 , respectively. The two rings R_1 and R_2 are internally attached to an axle. The axle may be mechanically rotated from outside to rotate the coil inside the magnetic field. Outer ends of the two brushes are connected to the galvanometer to show the flow of current in the given external circuit.

When the axle attached to the two rings is rotated such that the arm AB moves up (and the arm CD moves down) in the magnetic field produced by the permanent magnet. Let us say the coil ABCD

is rotated clockwise in the arrangement shown in Fig. 13.19. By applying Fleming's right-hand rule, the induced currents are set up in these arms along the directions AB and CD. Thus an induced current flows in the direction ABCD. If there are larger numbers of turns in the coil, the current generated in each turn adds up to give a large current through the coil. This means that the current in the external circuit flows from B_2 to B_1 .

After half a rotation, arm CD starts moving up and AB moving down. As a result, the directions of the induced currents in both the arms change, giving rise to the net induced current in the direction DCBA. The current in the external circuit now flows from B_1 to B_2 . Thus after every half rotation the polarity of the current in the respective arms changes. Such a current, which changes direction after equal intervals of time, is called an alternating current (abbreviated as AC). This device is called an AC generator.

To get a direct current (DC, which does not change its direction with time), a split-ring type commutator must be used. With this arrangement, one brush is at all times in contact with the arm moving up in the field, while the other is in contact with the arm moving down. We have seen the working of a split ring commutator in the case of an electric motor

(see Fig. 13.15). Thus a unidirectional current is produced. The generator is thus called a DC generator.

The difference between the direct and alternating currents is that the direct current always flows in one direction, whereas the alternating current reverses its direction periodically. Most power stations constructed these days produce AC. In India, the AC changes direction after every $1/100$ second, that is, the frequency of AC is 50 Hz. An important advantage of AC over DC is that electric power can be transmitted over long distances without much loss of energy.

Q U E S T I O N S

1. State the principle of an electric generator.
2. Name some sources of direct current.
3. Which sources produce alternating current?
4. Choose the correct option.

A rectangular coil of copper wires is rotated in a magnetic field. The direction of the induced current changes once in each

- (a) two revolutions (b) one revolution
(c) half revolution (d) one-fourth revolution



13.7 DOMESTIC ELECTRIC CIRCUITS

In our homes, we receive supply of electric power through a main supply (also called mains), either supported through overhead electric poles or by underground cables. One of the wires in this supply, usually with red insulation cover, is called live wire (or positive). Another wire, with black insulation, is called neutral wire (or negative). In our country, the potential difference between the two is 220 V.

At the meter-board in the house, these wires pass into an electricity meter through a main fuse. Through the main switch they are connected to the line wires in the house. These wires supply electricity to separate circuits within the house. Often, two separate circuits are used, one of 15 A current rating for appliances with higher power ratings such as geysers, air coolers, etc. The other circuit is of 5 A current rating for bulbs, fans, etc. The earth wire, which has insulation of green colour, is usually connected to a metal plate deep in the earth near the house. This is used as a safety measure, especially for those appliances that have a metallic body, for example, electric press, toaster, table fan, refrigerator, etc. The metallic body is connected to the earth wire, which provides a low-resistance conducting path for the current. Thus, it ensures that any leakage of current to the metallic body of the appliance keeps its potential to that of the earth, and the user may not get a severe electric shock.

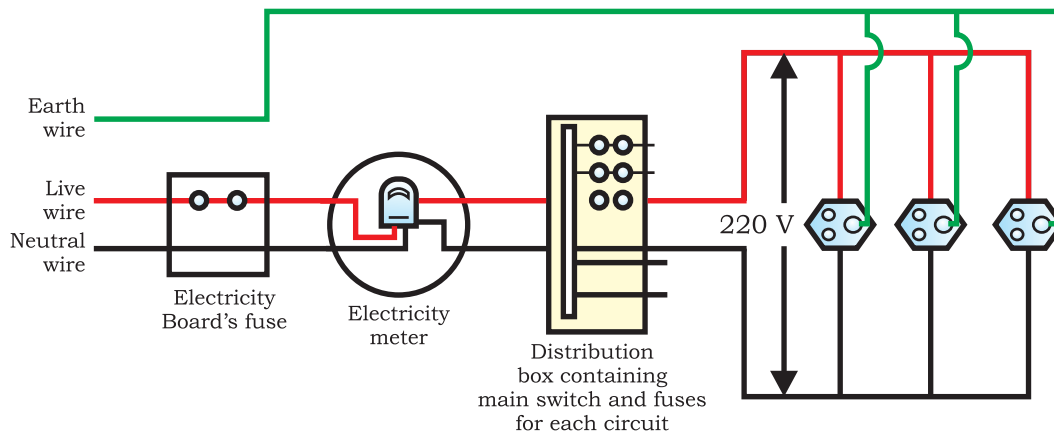

Figure 13.20 A schematic diagram of one of the common domestic circuits

Figure 13.20 gives a schematic diagram of one of the common domestic circuits. In each separate circuit, different appliances can be connected across the live and neutral wires. Each appliance has a separate switch to 'ON'/'OFF' the flow of current through it. In order that each appliance has equal potential difference, they are connected parallel to each other.

Electric fuse is an important component of all domestic circuits. We have already studied the principle and working of a fuse in the previous chapter (see Section 12.7). A fuse in a circuit prevents damage to the appliances and the circuit due to overloading. Overloading can occur when the live wire and the neutral wire come into direct contact. (This occurs when the insulation of wires is damaged or there is a fault in the appliance.) In such a situation, the current in the circuit abruptly increases. This is called short-circuiting. The use of an electric fuse prevents the electric circuit and the appliance from a possible damage by stopping the flow of unduly high electric current. The Joule heating that takes place in the fuse melts it to break the electric circuit. Overloading can also occur due to an accidental hike in the supply voltage. Sometimes overloading is caused by connecting too many appliances to a single socket.

Q U E S T I O N S

1. Name two safety measures commonly used in electric circuits and appliances.
2. An electric oven of 2 kW power rating is operated in a domestic electric circuit (220 V) that has a current rating of 5 A. What result do you expect? Explain.
3. What precaution should be taken to avoid the overloading of domestic electric circuits?



What you have learnt

- A compass needle is a small magnet. Its one end, which points towards north, is called a north pole, and the other end, which points towards south, is called a south pole.
- A magnetic field exists in the region surrounding a magnet, in which the force of the magnet can be detected.
- Field lines are used to represent a magnetic field. A field line is the path along which a hypothetical free north pole would tend to move. The direction of the magnetic field at a point is given by the direction that a north pole placed at that point would take. Field lines are shown closer together where the magnetic field is greater.
- A metallic wire carrying an electric current has associated with it a magnetic field. The field lines about the wire consist of a series of concentric circles whose direction is given by the right-hand rule.
- The pattern of the magnetic field around a conductor due to an electric current flowing through it depends on the shape of the conductor. The magnetic field of a solenoid carrying a current is similar to that of a bar magnet.
- An electromagnet consists of a core of soft iron wrapped around with a coil of insulated copper wire.
- A current-carrying conductor when placed in a magnetic field experiences a force. If the direction of the field and that of the current are mutually perpendicular to each other, then the force acting on the conductor will be perpendicular to both and will be given by Fleming's left-hand rule. This is the basis of an electric motor. An electric motor is a device that converts electric energy into mechanical energy.
- The phenomenon of electromagnetic induction is the production of induced current in a coil placed in a region where the magnetic field changes with time. The magnetic field may change due to a relative motion between the coil and a magnet placed near to the coil. If the coil is placed near to a current-carrying conductor, the magnetic field may change either due to a change in the current through the conductor or due to the relative motion between the coil and conductor. The direction of the induced current is given by the Fleming's right-hand rule.
- A generator converts mechanical energy into electrical energy. It works on the basis of electromagnetic induction.
- In our houses we receive AC electric power of 220 V with a frequency of 50 Hz. One of the wires in this supply is with red insulation, called live wire. The other one is of black insulation, which is a neutral wire. The potential difference between the two is 220 V. The third is the earth wire that has green insulation and this is connected to a metallic body deep inside earth. It is used as a safety measure to ensure that any leakage of current to a metallic body does not give any severe shock to a user.
- Fuse is the most important safety device, used for protecting the circuits due to short-circuiting or overloading of the circuits.

E X E R C I S E S

- Which of the following correctly describes the magnetic field near a long straight wire?
 - The field consists of straight lines perpendicular to the wire.
 - The field consists of straight lines parallel to the wire.
 - The field consists of radial lines originating from the wire.
 - The field consists of concentric circles centred on the wire.
- The phenomenon of electromagnetic induction is
 - the process of charging a body.
 - the process of generating magnetic field due to a current passing through a coil.
 - producing induced current in a coil due to relative motion between a magnet and the coil.
 - the process of rotating a coil of an electric motor.
- The device used for producing electric current is called a
 - generator.
 - galvanometer.
 - ammeter.
 - motor.
- The essential difference between an AC generator and a DC generator is that
 - AC generator has an electromagnet while a DC generator has permanent magnet.
 - DC generator will generate a higher voltage.
 - AC generator will generate a higher voltage.
 - AC generator has slip rings while the DC generator has a commutator.
- At the time of short circuit, the current in the circuit
 - reduces substantially.
 - does not change.
 - increases heavily.
 - vary continuously.
- State whether the following statements are true or false.
 - An electric motor converts mechanical energy into electrical energy.
 - An electric generator works on the principle of electromagnetic induction.
 - The field at the centre of a long circular coil carrying current will be parallel straight lines.
 - A wire with a green insulation is usually the live wire of an electric supply.
- List two methods of producing magnetic fields.

8. How does a solenoid behave like a magnet? Can you determine the north and south poles of a current-carrying solenoid with the help of a bar magnet? Explain.
9. When is the force experienced by a current-carrying conductor placed in a magnetic field largest?
10. Imagine that you are sitting in a chamber with your back to one wall. An electron beam, moving horizontally from back wall towards the front wall, is deflected by a strong magnetic field to your right side. What is the direction of magnetic field?
11. Draw a labelled diagram of an electric motor. Explain its principle and working. What is the function of a split ring in an electric motor?
12. Name some devices in which electric motors are used.
13. A coil of insulated copper wire is connected to a galvanometer. What will happen if a bar magnet is (i) pushed into the coil, (ii) withdrawn from inside the coil, (iii) held stationary inside the coil?
14. Two circular coils A and B are placed closed to each other. If the current in the coil A is changed, will some current be induced in the coil B? Give reason.
15. State the rule to determine the direction of a (i) magnetic field produced around a straight conductor-carrying current, (ii) force experienced by a current-carrying straight conductor placed in a magnetic field which is perpendicular to it, and (iii) current induced in a coil due to its rotation in a magnetic field.
16. Explain the underlying principle and working of an electric generator by drawing a labelled diagram. What is the function of brushes?
17. When does an electric short circuit occur?
18. What is the function of an earth wire? Why is it necessary to earth metallic appliances?



1064CH14

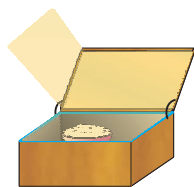

CHAPTER 14

Sources of Energy

In Class IX, we learnt that the total energy during a physical or chemical process is conserved. Why, then, do we hear so much about the energy crisis? If energy can neither be created nor destroyed, we should have no worries! We should be able to perform endless activities without thinking about energy resources!

This riddle can be solved if we recall what else we learnt about energy. Energy comes in different forms and one form can be converted to another. For example, if we drop a plate from a height, the potential energy of the plate is converted mostly to sound energy when it hits the ground. If we light a candle, the process is highly exothermic so that the chemical energy in the wax is converted to heat energy and light energy on burning. What other products are obtained when we burn a candle?

The total energy during a physical or chemical process remains the same but suppose we consider the burning candle again – can we somehow put together the heat and light generated along with the products of the reaction to get back the chemical energy in the form of wax?

Let us consider another example. Suppose we take 100 mL of water which has a temperature of 348 K (75°C) and leave it in a room where the temperature is 298 K (25°C). What will happen? Is there any way of collecting all the heat lost to the environment and making the water hot once it has cooled down?

In any example that we consider, we will see that energy, in the usable form, is dissipated to the surroundings in less usable forms. Hence, any source of energy we use, to do work, is consumed and cannot be used again.

14.1 WHAT IS A GOOD SOURCE OF ENERGY?

What can then be considered a good source of energy? We, in our daily lives, use energy from various sources for doing work. We use diesel to run our trains. We use electricity to light our street-lamps. Or we use energy in our muscles to cycle to school.

Activity 14.1

- List four forms of energy that you use from morning, when you wake up, till you reach the school.
- From where do we get these different forms of energy?
- Can we call these 'sources' of energy? Why or why not?

The muscular energy for carrying out physical work, electrical energy for running various appliances, chemical energy for cooking food or running a vehicle all come from some source. We need to know how do we select the source needed for obtaining the energy in its usable form.

Activity 14.2

- Consider the various options we have when we choose a fuel for cooking our food.
- What are the criteria you would consider when trying to categorise something as a good fuel?
- Would your choice be different if you lived
 - (a) in a forest?
 - (b) in a remote mountain village or small island?
 - (c) in New Delhi?
 - (d) lived five centuries ago?
- How are the factors different in each case?

After going through the two activities above, we can see that the particular source of energy, or fuel, we select for performing some work depends on many different factors. For example, while selecting a fuel, we would ask ourselves the following questions.

- (i) How much heat does it release on burning?
- (ii) Does it produce a lot of smoke?
- (iii) Is it easily available?

Can you think of three more relevant questions to ask about a fuel?

Given the range of fuels we have today, what are the factors which would limit our choices when it comes to a particular task like cooking our food? Would the fuel selected also depend on the work to be done? For example, would we choose one fuel for cooking and another for heating the room in winter?

We could then say that a good source of energy would be one

- which would do a large amount of work per unit volume or mass,
- be easily accessible,
- be easy to store and transport, and
- perhaps most importantly, be economical.

Q U E S T I O N S

1. What is a good source of energy?
2. What is a good fuel?
3. If you could use any source of energy for heating your food, which one would you use and why?



14.2 CONVENTIONAL SOURCES OF ENERGY

14.2.1 Fossil Fuels

In ancient times, wood was the most common source of heat energy. The energy of flowing water and wind was also used for limited activities. Can you think of some of these uses? The exploitation of coal as a source of energy made the industrial revolution possible. Increasing industrialisation has led to a better quality of life all over the world. It has also caused the global demand for energy to grow at a tremendous rate. The growing demand for energy was largely met by the fossil fuels – coal and petroleum. Our technologies were also developed for using these energy sources. But these fuels were formed over millions of years ago and there are only limited reserves. The fossil fuels are non-renewable

sources of energy, so we need to conserve them. If we were to continue consuming these sources at such alarming rates, we would soon run out of energy! In order to avoid this, alternate sources of energy were explored. But we continue to be largely dependent on fossil fuels for most of our energy requirements (Fig. 14.1).

Burning fossil fuels has other disadvantages too. We learnt in Class IX about the air pollution caused by burning of coal or petroleum products. The oxides of carbon, nitrogen and sulphur that are released on burning fossil fuels are acidic oxides. These lead to acid rain which affects our water and soil resources. In addition to the problem of air pollution, recall the green-house effect of gases like carbon dioxide.

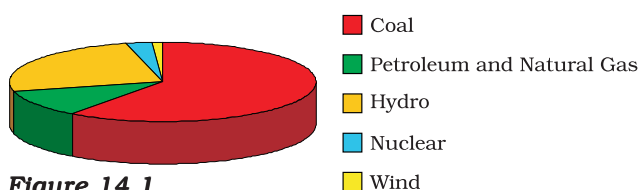

Figure 14.1
Pie-chart showing the major sources of energy for our requirements in India

Think it over

How would our lives change if we could no longer get electricity supply?
The availability of electrical energy to each individual in a country is one of the parameters to measure the growth of the country.

The pollution caused by burning fossil fuels can be somewhat reduced by increasing the efficiency of the combustion process and using various techniques to reduce the escape of harmful gases and ashes into the surroundings. Besides being used directly for various purposes – in gas stoves and vehicles, do you know fossil fuels are the major fuels used for generating electricity? Let us produce some electricity at our own small plant in the class and see what goes into producing our favourite form of energy.

Activity 14.3

- Take a table-tennis ball and make three slits into it.
- Put semicircular (\frown) fins cut out of a metal sheet into these slits.
- Pivot the tennis ball on an axle through its centre with a straight metal wire fixed to a rigid support. Ensure that the tennis ball rotates freely about the axle.

- Now connect a cycle dynamo to this.
- Connect a bulb in series.
- Direct a jet of water or steam produced in a pressure cooker at the fins (Fig. 14.2). What do you observe?

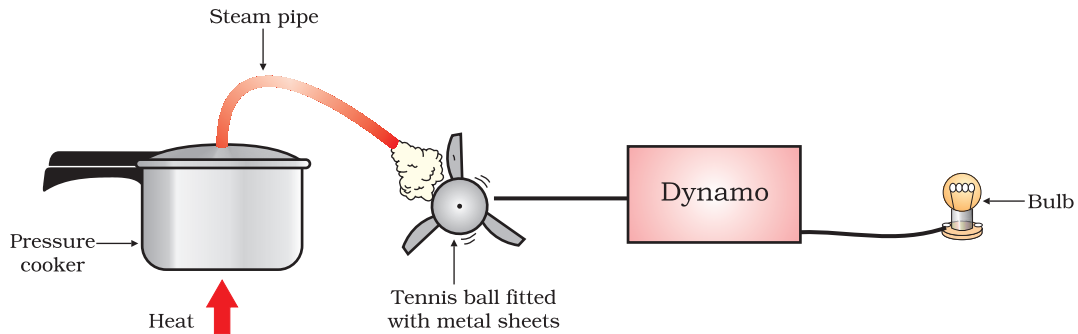

Figure 14.2 A model to demonstrate the process of thermoelectric production

This is our turbine for generating electricity. The simplest turbines have one moving part, a rotor-blade assembly. The moving fluid acts on the blades to spin them and impart energy to the rotor. Thus, we see that basically we need to move the fan, the rotor blade, with speed which would turn the shaft of the dynamo and convert the mechanical energy into electrical energy — the form of energy which has become a necessity in today's scenario. The various ways in which this can be done depends upon availability of the resources. We will see how various sources of energy can be harnessed to run the turbine and generate electricity in the following sections.

14.2.2 Thermal Power Plant

Large amount of fossil fuels are burnt every day in power stations to heat up water to produce steam which further runs the turbine to generate electricity. The transmission of electricity is more efficient than transporting coal or petroleum over the same distance. Therefore, many thermal power plants are set up near coal or oil fields. The term thermal power plant is used since fuel is burnt to produce heat energy which is converted into electrical energy.

14.2.3 Hydro Power Plants

Another traditional source of energy was the kinetic energy of flowing water or the potential energy of water at a height. Hydro power plants convert the potential energy of falling water into electricity. Since there are very few water-falls which could be used as a source of potential energy, hydro power plants are associated with dams. In the last century, a large number of dams were built all over the world. As we can see from Fig. 14.1, a quarter of our energy requirement in India is met by hydro power plants.

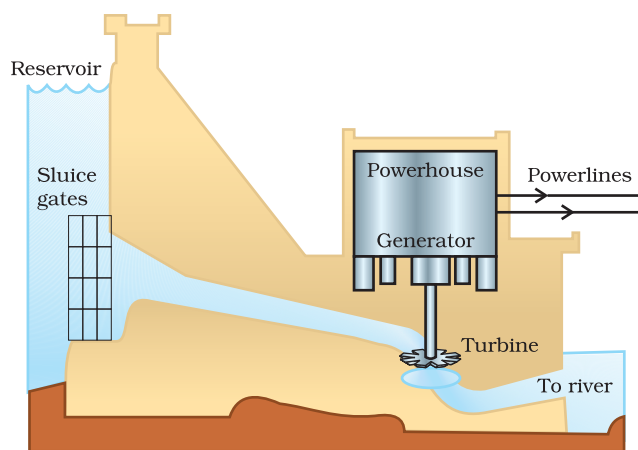

Figure 14.3
A schematic view of a hydro power plant

In order to produce hydel electricity, high-rise dams are constructed on the river to obstruct the flow of water and thereby collect water in larger reservoirs. The water level rises and in this process the kinetic energy of flowing water gets transformed into potential energy. The water from the high level in the dam is carried through pipes, to the turbine, at the bottom of the dam (Fig. 14.3). Since the water in the reservoir would be refilled each time it rains (hydro power is a renewable source of energy) we would not have to worry about hydro electricity sources getting used up the way fossil fuels would get finished one day.

But, constructions of big dams have certain problems associated with it. The dams can be constructed only in a limited number of places, preferably in hilly terrains. Large areas of agricultural land and human habitation are to be sacrificed as they get submerged. Large eco-systems are destroyed when submerged under the water in dams. The vegetation which is submerged rots under anaerobic conditions and gives rise to large amounts of methane which is also a green-house gas. It creates the problem of satisfactory rehabilitation of displaced people. Opposition to the construction of Tehri Dam on the river Ganga and Sardar Sarovar project on the river Narmada are due to such problems.

14.2.4 Improvements in the Technology for using Conventional Sources of Energy

Bio-Mass

We mentioned earlier that wood has been used as a fuel for a long time. If we can ensure that enough trees are planted, a continuous supply of fire-wood can be assured. You must also be familiar with the use of cow-dung cakes as a fuel. Given the large live-stock population in India, this can also assure us a steady source of fuel. Since these fuels are plant and animal products, the source of these fuels is said to be bio-mass. These fuels, however, do not produce much heat on burning and a lot of smoke is given out when they are burnt. Therefore, technological inputs to improve the efficiency of these fuels are necessary. When wood is burnt in a limited supply of oxygen, water and volatile materials present in it get removed and charcoal is left behind as the residue. Charcoal burns without flames, is comparatively smokeless and has a higher heat generation efficiency.

Similarly, cow-dung, various plant materials like the residue after harvesting the crops, vegetable waste and sewage are decomposed in the absence of oxygen to give bio-gas. Since the starting material is mainly cow-dung, it is popularly known as 'gobar-gas'. Bio-gas is produced in a plant as shown in Fig. 14.4.

The plant has a dome-like structure built with bricks. A slurry of cow-dung and water is made in the mixing tank from where it is fed into the digester. The digester is a sealed chamber in which there is no oxygen. Anaerobic micro-organisms that do not require oxygen decompose or break down complex compounds of the cow-dung slurry. It takes a few days for the decomposition process to be complete and generate gases like methane, carbon dioxide, hydrogen and hydrogen sulphide. The bio-gas is stored in the gas tank above the digester from which they are drawn through pipes for use.

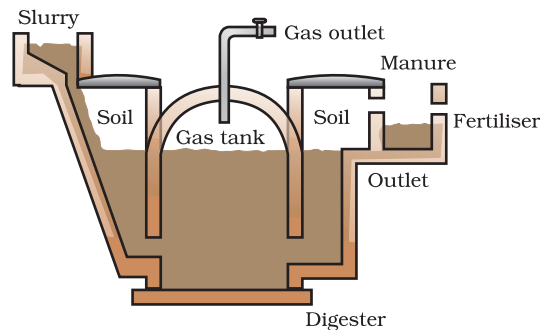

Figure 14.4
Schematic diagram of a bio-gas plant

Bio-gas is an excellent fuel as it contains up to 75% methane. It burns without smoke, leaves no residue like ash in wood, charcoal and coal burning. Its heating capacity is high. Bio-gas is also used for lighting. The slurry left behind is removed periodically and used as excellent manure, rich in nitrogen and phosphorous. The large-scale utilisation of bio-waste and sewage material provides a safe and efficient method of waste-disposal besides supplying energy and manure. Do you think that bio-mass is a renewable source of energy?

Wind Energy

We saw in Class IX how unequal heating of the landmass and water bodies by solar radiation generates air movement and causes winds to blow. This kinetic energy of the wind can be used to do work. This energy was harnessed by windmills in the past to do mechanical work. For example, in a water-lifting pump, the rotatory motion of windmill is utilised to lift water from a well. Today, wind energy is also used to generate electricity. A windmill essentially consists of a structure similar to a large electric fan that is erected at some height on a rigid support (Fig. 14.5).

To generate electricity, the rotatory motion of the windmill is used to turn the turbine of the electric generator. The output of a single windmill is quite small and cannot be used for commercial purposes. Therefore, a number of windmills are erected over a large area, which is known as wind energy farm. The energy output of each windmill in a farm is coupled together to get electricity on a commercial scale.

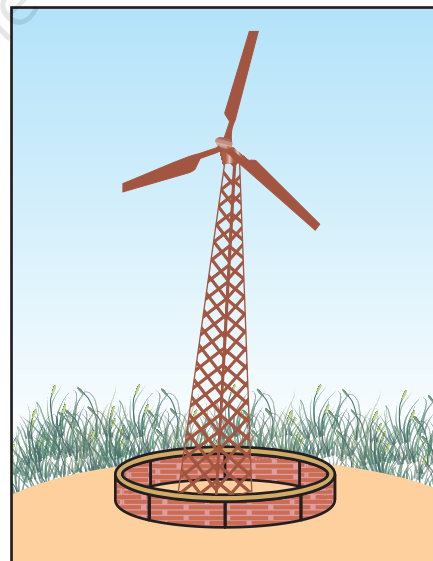

Figure 14.5 A windmill

Do You Know?

Denmark is called the country of 'winds'. More than 25% of their electricity needs are generated through a vast network of windmills. In terms of total output, Germany is the leader, while India is ranked fifth in harnessing wind energy for the production of electricity. It is estimated that nearly 45,000 MW of electrical power can be generated if India's wind potential is fully exploited. The largest wind energy farm has been established near Kanyakumari in Tamil Nadu and it generates 380 MW of electricity.

Wind energy is an environment-friendly and efficient source of renewable energy. It requires no recurring expenses for the production of electricity. But there are many limitations in harnessing wind energy. Firstly, wind energy farms can be established only at those places where wind blows for the greater part of a year. The wind speed should also be higher than 15 km/h to maintain the required speed of the turbine. Furthermore, there should be some back-up facilities (like storage cells) to take care of the energy needs during a period when there is no wind. Establishment of wind energy farms requires large area of land. For a 1 MW generator, the farm needs about 2 hectares of land. The initial cost of establishment of the farm is quite high. Moreover, since the tower and blades are exposed to the vagaries of nature like rain, Sun, storm and cyclone, they need a high level of maintenance.

Q U E S T I O N S

1. What are the disadvantages of fossil fuels?
2. Why are we looking at alternate sources of energy?
3. How has the traditional use of wind and water energy been modified for our convenience?



14.3 ALTERNATIVE OR NON-CONVENTIONAL SOURCES OF ENERGY

With technological progress, our demand for energy increases day by day. Our life-styles are also changing, we use machines to do more and more of our tasks. Our basic requirements are also increasing as industrialisation improves our living standards.

Activity 14.4

- Find out from your grand-parents or other elders –
 - (a) how did they go to school?
 - (b) how did they get water for their daily needs when they were young?
 - (c) what means of entertainment did they use?
- Compare the above answers with how you do these tasks now.
- Is there a difference? If yes, in which case more energy from external sources is consumed?

As our demand for energy increases, we need to look for more and more sources of energy. We could develop the technology to use the available or known sources of energy more efficiently and also look to new sources of energy. Any new source of energy we seek to exploit would need specific devices developed with that source in mind. We shall now look at some of the latest sources of energy that we seek to tap, and the technology designed to capture and store energy from that source.

Think it over!

Some people say that if we start living as our ancestors, this would conserve energy and our ecosystem. Do you think this idea is feasible?

14.3.1 Solar Energy

The Sun has been radiating an enormous amount of energy at the present rate for nearly 5 billion years and will continue radiating at that rate for about 5 billion years more. Only a small part of solar energy reaches the outer layer of the earth's atmosphere. Nearly half of it is absorbed while passing through the atmosphere and the rest reaches the earth's surface.

Do You Know?

India is lucky to receive solar energy for greater part of the year. It is estimated that during a year India receives the energy equivalent to more than 5,000 trillion kWh. Under clear (cloudless) sky conditions, the daily average varies from 4 to 7 kWh/m². The solar energy reaching unit area at outer edge of the earth's atmosphere exposed perpendicularly to the rays of the Sun at the average distance between the Sun and earth is known as the solar constant. It is estimated to be approximately 1.4 kJ per second per square metre or 1.4 kW/m².

Activity 14.5

- Take two conical flasks and paint one white and the other black. Fill both with water.
- Place the conical flasks in direct sunlight for half an hour to one hour.
- Touch the conical flasks. Which one is hotter? You could also measure the temperature of the water in the two conical flasks with a thermometer.
- Can you think of ways in which this finding could be used in your daily life?

A black surface absorbs more heat as compared to a white or a reflecting surface under identical conditions. Solar cookers (Fig. 14.6) and solar water heaters use this property in their working. Some solar cookers achieve a higher temperature by using mirrors to focus the rays of the Sun. Solar cookers are covered with a glass plate. Recall what we have learnt about the green-house effect. Does this explain why a glass plate is used?

Activity 14.6

- Study the structure and working of a solar cooker and/or a solar water-heater, particularly with regard to how it is insulated and maximum heat absorption is ensured.

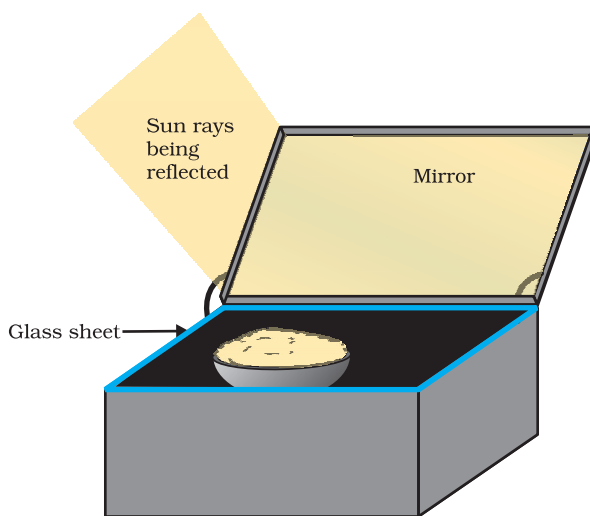

Figure 14.6 A solar cooker

- Design and build a solar cooker or water-heater using low-cost material available and check what temperatures are achieved in your system.
- Discuss what would be the advantages and limitations of using the solar cooker or water-heater.



Figure 14.7
A solar cell panel

It is easy to see that these devices are useful only at certain times during the day. This limitation of using solar energy is overcome by using solar cells that convert solar energy into electricity. A typical cell develops a voltage of 0.5–1 V and can produce about 0.7 W of electricity when exposed to the Sun. A large number of solar cells are, combined in an arrangement called solar cell panel (Fig. 14.7) that can deliver enough electricity for practical use.

The principal advantages associated with solar cells are that they have no moving parts, require little maintenance and work quite satisfactorily without the use of any focussing device. Another advantage is that they can be set up in remote and inaccessible hamlets or very sparsely inhabited areas in which laying of a power transmission line may be expensive and not commercially viable.

Silicon, which is used for making solar cells, is abundant in nature but availability of the special grade silicon for making solar cells is limited. The entire process of manufacture is still very expensive, silver used for interconnection of the cells in the panel further adds to the cost. In spite of the high cost and low efficiency, solar cells are used for many scientific and technological applications. Artificial satellites and space probes like Mars orbiters use solar cells as the main source of energy. Radio or wireless transmission systems or TV relay stations in remote locations use solar cell panels. Traffic signals, calculators and many toys are fitted with solar cells. The solar cell panels are mounted on specially designed inclined roof tops so that more solar energy is incident over it. The domestic use of solar cells is, however, limited due to its high cost.

14.3.2 Energy from the Sea

Tidal Energy

Due to the gravitational pull of mainly the moon on the spinning earth, the level of water in the sea rises and falls. If you live near the sea or ever travel to some place near the sea, try and observe how the sea-level changes during the day. This phenomenon is called high and low tides and the difference in sea-levels gives us tidal energy. Tidal energy is harnessed by constructing a dam across a narrow opening to the sea. A turbine fixed at the opening of the dam converts tidal energy to electricity. As you can guess, the locations where such dams can be built are limited.

Wave Energy

Similarly, the kinetic energy possessed by huge waves near the sea-shore can be trapped in a similar manner to generate electricity. The waves are generated by strong winds blowing across the sea. Wave energy would be a viable proposition only where waves are very strong. A wide variety of devices have been developed to trap wave energy for rotation of turbine and production of electricity.

Ocean Thermal Energy

The water at the surface of the sea or ocean is heated by the Sun while the water in deeper sections is relatively cold. This difference in temperature is exploited to obtain energy in ocean-thermal-energy conversion plants. These plants can operate if the temperature difference between the water at the surface and water at depths up to 2 km is 20 K (20°C) or more. The warm surface-water is used to boil a volatile liquid like ammonia. The vapours of the liquid are then used to run the turbine of generator. The cold water from the depth of the ocean is pumped up and condense vapour again to liquid.

The energy potential from the sea (tidal energy, wave energy and ocean thermal energy) is quite large, but efficient commercial exploitation is difficult.

14.3.3 Geothermal Energy

Due to geological changes, molten rocks formed in the deeper hot regions of earth's crust are pushed upward and trapped in certain regions called 'hot spots'. When underground water comes in contact with the hot spot, steam is generated. Sometimes hot water from that region finds outlets at the surface. Such outlets are known as hot springs. The steam trapped in rocks is routed through a pipe to a turbine and used to generate electricity. The cost of production would not be much, but there are very few commercially viable sites where such energy can be exploited. There are number of power plants based on geothermal energy operational in New Zealand and United States of America.

14.3.4 Nuclear Energy

How is nuclear energy generated? In a process called nuclear fission, the nucleus of a heavy atom (such as uranium, plutonium or thorium), when bombarded with low-energy neutrons, can be split apart into lighter nuclei. When this is done, a tremendous amount of energy is released if the mass of the original nucleus is just a little more than the sum of the masses of the individual products. The fission of an atom of uranium, for example, produces 10 million times the energy produced by the combustion of an atom of carbon from coal. In a nuclear reactor designed for electric power generation, such nuclear 'fuel' can be part of a self-sustaining fission chain reaction that releases energy at a controlled rate. The released energy can be used to produce steam and further generate electricity.

Do You Know?

In a nuclear fission, the difference in mass, Δm , between the original nucleus and the product nuclei gets converted to energy E at a rate governed by the famous equation,

$$E = \Delta m c^2,$$

first derived by Albert Einstein in 1905, where c is the speed of light in vacuum. In nuclear science, energy is often expressed in units of electron volts (eV): $1 \text{ eV} = 1.602 \times 10^{-19}$ joules. It is easy to check from the above equation that 1 atomic mass unit (u) is equivalent to about 931 mega electron volts (MeV) of energy.

Nuclear power reactors located at Tarapur (Maharashtra), Rana Pratap Sagar (Rajasthan), Kalpakkam (Tamil Nadu), Narora (UP), Kakrapar (Gujarat) and Kaiga (Karnataka) have the installed capacity of less than 3% of the total electricity generation capacity of our country. However, many industrialised countries are meeting more than 30% of their electrical power needs from nuclear reactors.

The major hazard of nuclear power generation is the storage and disposal of spent or used fuels – the uranium still decaying into harmful subatomic particles (radiations). Improper nuclear-waste storage and disposal result in environmental contamination. Further, there is a risk of accidental leakage of nuclear radiation. The high cost of installation of a nuclear power plant, high risk of environmental contamination and limited availability of uranium makes large-scale use of nuclear energy prohibitive.

Nuclear energy was first used for destructive purposes before nuclear power stations were designed. The fundamental physics of the fission chain reaction in a nuclear weapon is similar to the physics of a controlled nuclear reactor, but the two types of device are engineered quite differently.

Do You Know?

Nuclear fusion

Currently all commercial nuclear reactors are based on nuclear fission. But there is another possibility of nuclear energy generation by a safer process called nuclear fusion. Fusion means joining lighter nuclei to make a heavier nucleus, most commonly hydrogen or hydrogen isotopes to create helium, such as



It releases a tremendous amount of energy, according to the Einstein equation, as the mass of the product is little less than the sum of the masses of the original individual nuclei.

Such nuclear fusion reactions are the source of energy in the Sun and other stars. It takes considerable energy to force the nuclei to fuse. The conditions needed for this process are extreme – millions of degrees of temperature and millions of pascals of pressure.

The hydrogen bomb is based on thermonuclear fusion reaction. A nuclear bomb based on the fission of uranium or plutonium is placed at the core of the hydrogen bomb. This nuclear bomb is embedded in a substance which contains deuterium and lithium. When the nuclear bomb (based on fission) is detonated, the temperature of this substance is raised to 10^7 K in a few microseconds. The high temperature generates sufficient energy for the light nuclei to fuse and a devastating amount of energy is released.

Activity 14.7

- Discuss in class the question of what is the ultimate source of energy for bio-mass, wind and ocean thermal energy.
- Is geothermal energy and nuclear energy different in this respect? Why?
- Where would you place hydro electricity and wave energy?

Q U E S T I O N S

1. What kind of mirror – concave, convex or plain – would be best suited for use in a solar cooker? Why?
2. What are the limitations of the energy that can be obtained from the oceans?
3. What is geothermal energy?
4. What are the advantages of nuclear energy?



14.4 ENVIRONMENTAL CONSEQUENCES

We have studied various sources of energy in the previous sections. Exploiting any source of energy disturbs the environment in some way or the other. In any given situation, the source we would choose depends on factors such as the ease of extracting energy from that source, the economics of extracting energy from the source, the efficiency of the technology available and the environmental damage that will be caused by using that source. Though we talk of ‘clean’ fuels like CNG, it would be more exact to say that a particular source is cleaner than the other. We have already seen that burning fossil fuels causes air pollution. In some cases, the actual operation of a device like the solar cell may be pollution-free, but the assembly of the device would have caused some environmental damage. Research continues in these areas to produce longer lasting devices that will cause less damage throughout their life.

Activity 14.8

- Gather information about various energy sources and how each one affects the environment.
- Debate the merits and demerits of each source and select the best source of energy on this basis.

Q U E S T I O N S

1. Can any source of energy be pollution-free? Why or why not?
2. Hydrogen has been used as a rocket fuel. Would you consider it a cleaner fuel than CNG? Why or why not?



14.5 HOW LONG WILL AN ENERGY SOURCE LAST US?

We saw earlier that we cannot depend on the fossil fuels for much longer. Such sources that will get depleted some day are said to be exhaustible sources or non-renewable sources of energy. On the other hand, if we manage bio-mass by replacing the trees we cut down for fire-wood, we can be assured of a constant supply of energy at a particular rate. Such energy sources that can be regenerated are called renewable sources of energy.

Renewable energy is available in our natural environment, in the form of some continuing or repetitive currents of energy, or is stored in such large underground reservoirs that the rate of depletion of the reservoir because of extraction of usable energy is practically negligible.

Activity 14.9

- Debate the following two issues in class.
 - (a) The estimated coal reserves are said to be enough to last us for another two hundred years. Do you think we need to worry about coal getting depleted in this case? Why or why not?
 - (b) It is estimated that the Sun will last for another five billion years. Do we have to worry about solar energy getting exhausted? Why or why not?
- On the basis of the debate, decide which energy sources can be considered (i) exhaustible, (ii) inexhaustible, (iii) renewable and (iv) non-renewable. Give your reasons for each choice.

Q U E S T I O N S

1. Name two energy sources that you would consider to be renewable. Give reasons for your choices.
2. Give the names of two energy sources that you would consider to be exhaustible. Give reasons for your choices.



What you have learnt

- Our energy requirements increase with our standard of living.
- In order to fulfil our energy requirements, we try to improve the efficiency of energy usage and also try and exploit new sources of energy.
- We also need to look for new sources of energy because the conventional sources of energy like fossil fuels are in danger of getting exhausted soon.
- The energy source we select would depend on factors like the ease and cost of extracting energy from the source, the efficiency of the technology available for using that source of energy and the environmental impact of using that source.
- Many of the sources ultimately derive their energy from the Sun.

E X E R C I S E S

1. A solar water heater cannot be used to get hot water on
 - (a) a sunny day.
 - (b) a cloudy day.
 - (c) a hot day.
 - (d) a windy day.



1064CH15



CHAPTER 15

Our Environment

We have heard the word ‘environment’ often being used on the television, in newspapers and by people around us. Our elders tell us that the ‘environment’ is not what it used to be earlier; others say that we should work in a healthy ‘environment’; and global summits involving the developed and developing countries are regularly held to discuss ‘environmental’ issues. In this chapter, we shall be studying how various components in the environment interact with each other and how we impact the environment.

15.1 ECO-SYSTEM — WHAT ARE ITS COMPONENTS?

All organisms such as plants, animals, microorganisms and human beings as well as the physical surroundings interact with each other and maintain a balance in nature. All the interacting organisms in an area together with the non-living constituents of the environment form an ecosystem. Thus, an ecosystem consists of biotic components comprising living organisms and abiotic components comprising physical factors like temperature, rainfall, wind, soil and minerals.

For example, if you visit a garden you will find different plants, such as grasses, trees; flower bearing plants like rose, jasmine, sunflower; and animals like frogs, insects and birds. All these living organisms interact with each other and their growth, reproduction and other activities are affected by the abiotic components of ecosystem. So a garden is an ecosystem. Other types of ecosystems are forests, ponds and lakes. These are natural ecosystems while gardens and crop-fields are human-made (artificial) ecosystems.

Activity 15.1

- You might have seen an aquarium. Let us try to design one.
- What are the things that we need to keep in mind when we create an aquarium? The fish would need a free space for swimming (it could be a large jar), water, oxygen and food.
- We can provide oxygen through an oxygen pump (aerator) and fish food which is available in the market.

- If we add a few aquatic plants and animals it can become a self-sustaining system. Can you think how this happens? An aquarium is an example of a human-made ecosystem.
- Can we leave the aquarium as such after we set it up? Why does it have to be cleaned once in a while? Do we have to clean ponds or lakes in the same manner? Why or why not?

We have seen in earlier classes that organisms can be grouped as producers, consumers and decomposers according to the manner in which they obtain their sustenance from the environment. Let us recall what we have learnt through the self sustaining ecosystem created by us above. Which organisms can make organic compounds like sugar and starch from inorganic substances using the radiant energy of the Sun in the presence of chlorophyll? All green plants and certain bacteria which can produce food by photosynthesis come under this category and are called the producers.

Organisms depend on the producers either directly or indirectly for their sustenance? These organisms which consume the food produced, either directly from producers or indirectly by feeding on other consumers are the consumers. Consumers can be classed variously as herbivores, carnivores, omnivores and parasites. Can you give examples for each of these categories of consumers?

- Imagine the situation where you do not clean the aquarium and some fish and plants have died. Have you ever thought what happens when an organism dies? The microorganisms, comprising bacteria and fungi, break-down the dead remains and waste products of organisms. These microorganisms are the decomposers as they break-down the complex organic substances into simple inorganic substances that go into the soil and are used up once more by the plants. What will happen to the garbage, and dead animals and plants in their absence? Will the natural replenishment of the soil take place, even if decomposers are not there?

Activity 15.2

- While creating an aquarium did you take care not to put an aquatic animal which would eat others? What would have happened otherwise?
- Make groups and discuss how each of the above groups of organisms are dependent on each other.
- Write the aquatic organisms in order of who eats whom and form a chain of at least three steps. → →
- Would you consider any one group of organisms to be of primary importance? Why or why not?

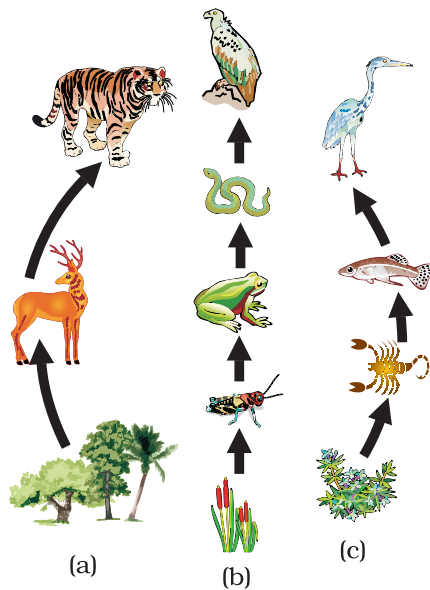

Figure 15.1
Food chain in nature
(a) in forest, (b) in
grassland and (c) in a
pond

15.1.1 Food Chains and Webs

In Activity 15.4 we have formed a series of organisms feeding on one another. This series of organisms taking part at various biotic levels form a food chain (Fig. 15.1).

Each step or level of the food chain forms a trophic level. The autotrophs or the producers are at the first trophic level. They fix up the solar energy and make it available for heterotrophs or the consumers. The herbivores or the primary consumers come at the second, small carnivores or the secondary consumers at the third and larger carnivores or the tertiary consumers form the fourth trophic level (Fig. 15.2).

We know that the food we eat acts as a fuel to provide us energy to do work. Thus the interactions among various components of the environment involves flow of energy from one component of the system to another. As we have studied, the autotrophs capture the energy present in sunlight and convert it into chemical energy. This energy supports all the activities of the living world. From autotrophs, the energy goes to the heterotrophs and decomposers. However, as we saw in the previous Chapter on 'Sources of Energy', when one form of energy is changed to another, some energy is lost to the environment in forms which cannot be used again. The flow of energy between various components of the environment has been extensively studied and it has been found that –

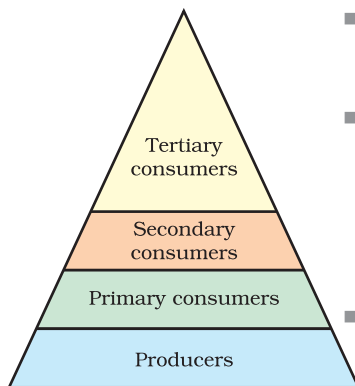

Figure 15.2
Trophic levels

- The green plants in a terrestrial ecosystem capture about 1% of the energy of sunlight that falls on their leaves and convert it into food energy.
- When green plants are eaten by primary consumers, a great deal of energy is lost as heat to the environment, some amount goes into digestion and in doing work and the rest goes towards growth and reproduction. An average of 10% of the food eaten is turned into its own body and made available for the next level of consumers.
- Therefore, 10% can be taken as the average value for the amount of organic matter that is present at each step and reaches the next level of consumers.
- Since so little energy is available for the next level of consumers, food chains generally consist of only three or four steps. The loss of energy at each step is so great that very little usable energy remains after four trophic levels.
- There are generally a greater number of individuals at the lower trophic levels of an ecosystem, the greatest number is of the producers.
- The length and complexity of food chains vary greatly. Each organism is generally eaten by two or more other kinds of organisms which in turn are eaten by several other organisms. So instead of a straight line food chain, the relationship can be shown as a series of branching lines called a food web (Fig. 15.3).

From the energy flow diagram (Fig. 15.4), two things become clear. Firstly, the flow of energy is unidirectional. The energy that is captured by the autotrophs does not revert back to the solar input and the energy which passes to the herbivores does not come back to autotrophs. As it moves progressively through the various trophic levels it is no longer available to the previous level. Secondly, the energy available at each trophic level gets diminished progressively due to loss of energy at each level.

Another interesting aspect of food chain is how unknowingly some harmful chemicals enter our bodies through the food chain. You have read in Class IX how water gets polluted. One of the reasons is the use of several pesticides and other chemicals to protect our crops from diseases and pests. These chemicals are either washed down into the soil or into the water bodies. From the soil, these are absorbed by the plants along with water and minerals, and from the water bodies these are taken up by aquatic plants

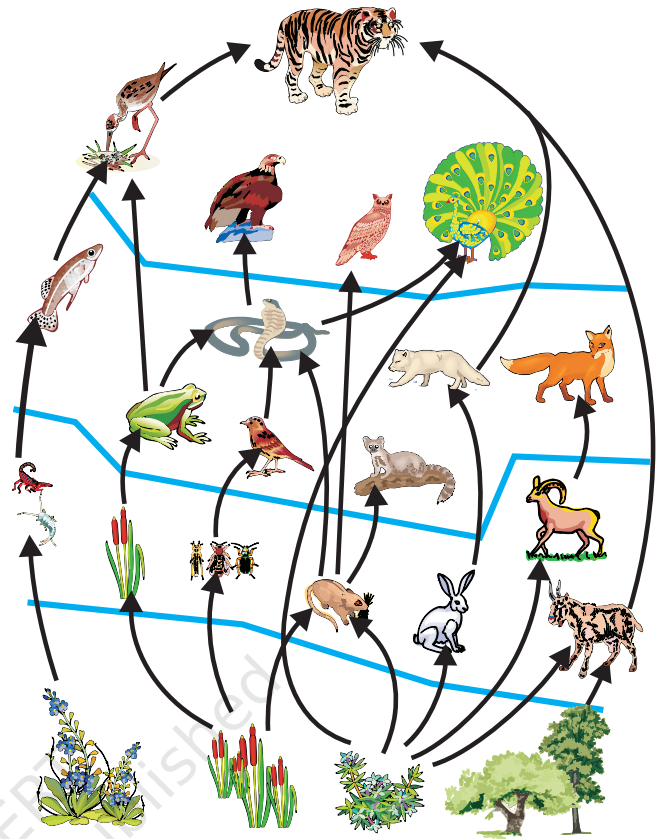

Figure 15.3
Food web, consisting of many food chains

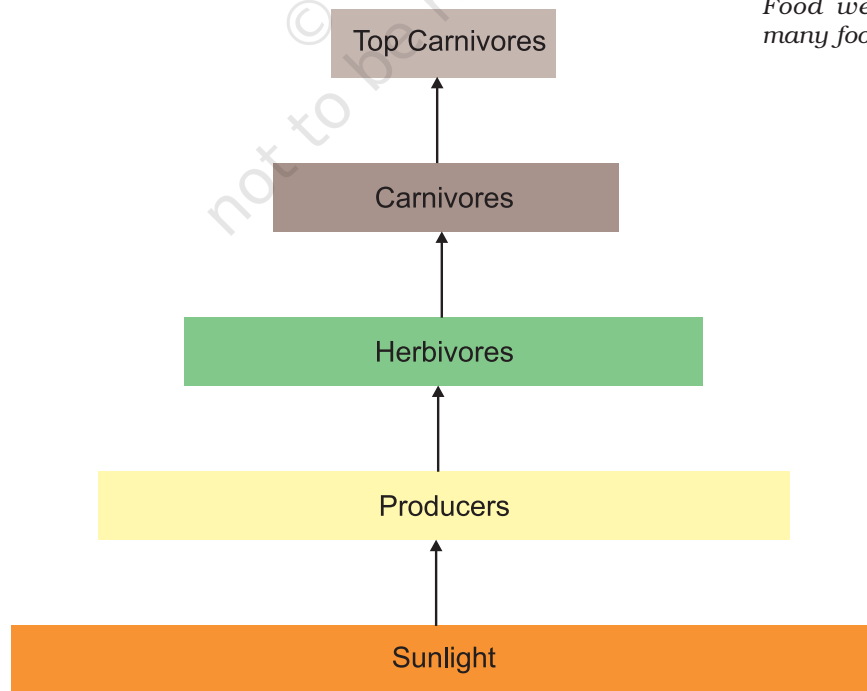

Figure 15.4 Diagram showing flow of energy in an ecosystem

and animals. This is one of the ways in which they enter the food chain. As these chemicals are not degradable, these get accumulated progressively at each trophic level. As human beings occupy the top level in any food chain, the maximum concentration of these chemicals get accumulated in our bodies. This phenomenon is known as biological magnification. This is the reason why our food grains such as wheat and rice, vegetables and fruits, and even meat, contain varying amounts of pesticide residues. They cannot always be removed by washing or other means.

Activity 15.3

- Newspaper reports about pesticide levels in ready-made food items are often seen these days and some states have banned these products. Debate in groups the need for such bans.
- What do you think would be the source of pesticides in these food items? Could pesticides get into our bodies from this source through other food products too?
- Discuss what methods could be applied to reduce our intake of pesticides.

Q U E S T I O N S

1. What are trophic levels? Give an example of a food chain and state the different trophic levels in it.
2. What is the role of decomposers in the ecosystem?



15.2 HOW DO OUR ACTIVITIES AFFECT THE ENVIRONMENT?

We are an integral part of the environment. Changes in the environment affect us and our activities change the environment around us. We have already seen in Class IX how our activities pollute the environment. In this chapter, we shall be looking at two of the environmental problems in detail, that is, depletion of the ozone layer and waste disposal.

15.2.1 Ozone Layer and How it is Getting Depleted

Ozone (O_3) is a molecule formed by three atoms of oxygen. While O_2 , which we normally refer to as oxygen, is essential for all aerobic forms of life. Ozone, is a deadly poison. However, at the higher levels of the atmosphere, ozone performs an essential function. It shields the surface of the earth from ultraviolet (UV) radiation from the Sun. This radiation

is highly damaging to organisms, for example, it is known to cause skin cancer in human beings.

Ozone at the higher levels of the atmosphere is a product of UV radiation acting on oxygen (O_2) molecule. The higher energy UV radiations split apart some molecular oxygen (O_2) into free oxygen (O) atoms. These atoms then combine with the molecular oxygen to form ozone as shown—

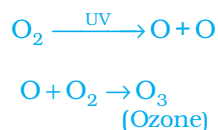

The amount of ozone in the atmosphere began to drop sharply in the 1980s. This decrease has been linked to synthetic chemicals like chlorofluorocarbons (CFCs) which are used as refrigerants and in fire extinguishers. In 1987, the United Nations Environment Programme (UNEP) succeeded in forging an agreement to freeze CFC production at 1986 levels. It is now mandatory for all the manufacturing companies to make CFC-free refrigerators throughout the world.

Activity 15.4

- Find out from the library, internet or newspaper reports, which chemicals are responsible for the depletion of the ozone layer.
- Find out if the regulations put in place to control the emission of these chemicals have succeeded in reducing the damage to the ozone layer. Has the size of the hole in the ozone layer changed in recent years?

15.2.2 Managing the Garbage we Produce

In our daily activities, we generate a lot of material that are thrown away. What are some of these waste materials? What happens after we throw them away? Let us perform an activity to find answers to these questions.

Activity 15.5

- Collect waste material from your homes. This could include all the waste generated during a day, like kitchen waste (spoilt food, vegetable peels, used tea leaves, milk packets and empty cartons), waste paper, empty medicine bottles/strips/bubble packs, old and torn clothes and broken footwear.
- Bury this material in a pit in the school garden or if there is no space available, you can collect the material in an old bucket/flower pot and cover with at least 15 cm of soil.
- Keep this material moist and observe at 15-day intervals.
- What are the materials that remain unchanged over long periods of time?
- What are the materials which change their form and structure over time?
- Of these materials that are changed, which ones change the fastest?

We have seen in the chapter on 'Life Processes' that the food we eat is digested by various enzymes in our body. Have you ever wondered why the same enzyme does not break-down everything we eat? Enzymes are specific in their action, specific enzymes are needed for the break-down of a particular substance. That is why we will not get any energy if we try to eat coal! Because of this, many human-made materials like plastics will not be broken down by the action of bacteria or other saprophytes. These materials will be acted upon by physical processes like heat and pressure, but under the ambient conditions found in our environment, these persist for a long time.

Substances that are broken down by biological processes are said to be biodegradable. How many of the substances you buried were biodegradable? Substances that are not broken down in this manner are said to be non-biodegradable. These substances may be inert and simply persist in the environment for a long time or may harm the various members of the eco-system.

Activity 15.6

- Use the library or internet to find out more about biodegradable and non-biodegradable substances.
- How long are various non-biodegradable substances expected to last in our environment?
- These days, new types of plastics which are said to be biodegradable are available. Find out more about such materials and whether they do or do not harm the environment.

Q U E S T I O N S

1. Why are some substances biodegradable and some non-biodegradable?
2. Give any two ways in which biodegradable substances would affect the environment.
3. Give any two ways in which non-biodegradable substances would affect the environment.



Visit any town or city, and we are sure to find heaps of garbage all over the place. Visit any place of tourist interest and we are sure to find the place littered with empty food wrappers. In the earlier classes we have talked about this problem of dealing with the garbage that we generate. Let us now look at the problem a bit more deeply.

Activity 15.7

- Find out what happens to the waste generated at home. Is there a system in place to collect this waste?
- Find out how the local body (*panchayat*, municipal corporation, resident welfare association) deals with the waste. Are there mechanisms in place to treat the biodegradable and non-biodegradable wastes separately?
- Calculate how much waste is generated at home in a day.
- How much of this waste is biodegradable?
- Calculate how much waste is generated in the classroom in a day.
- How much of this waste is biodegradable?
- Suggest ways of dealing with this waste.

Activity 15.8

- Find out how the sewage in your locality is treated. Are there mechanisms in place to ensure that local water bodies are not polluted by untreated sewage.
- Find out how the local industries in your locality treat their wastes. Are there mechanisms in place to ensure that the soil and water are not polluted by this waste?

Improvements in our life-style have resulted in greater amounts of waste material generation. Changes in attitude also have a role to play, with more and more things we use becoming disposable. Changes in packaging have resulted in much of our waste becoming non-biodegradable. What do you think will be the impact of these on our environment?

Think it over

Disposable cups in trains

If you ask your parents, they will probably remember a time when tea in trains was served in plastic glasses which had to be returned to the vendor. The introduction of disposable cups was hailed as a step forward for reasons of hygiene. No one at that time perhaps thought about the impact caused by the disposal of millions of these cups on a daily basis. Some time back, *kulhads*, that is, disposable cups made of clay, were suggested as an alternative. But a little thought showed that making these *kulhads* on a large scale would result in the loss of the fertile top-soil. Now disposable paper-cups are being used. What do you think are the advantages of disposable paper-cups over disposable plastic cups?

Activity 15.9

- Search the internet or library to find out what hazardous materials have to be dealt with while disposing of electronic items. How would these materials affect the environment?
- Find out how plastics are recycled. Does the recycling process have any impact on the environment?

Q U E S T I O N S

1. What is ozone and how does it affect any ecosystem?
2. How can you help in reducing the problem of waste disposal? Give any two methods.



What you have learnt

- The various components of an ecosystem are interdependent.
- The producers make the energy from sunlight available to the rest of the ecosystem.
- There is a loss of energy as we go from one trophic level to the next, this limits the number of trophic levels in a food-chain.
- Human activities have an impact on the environment.
- The use of chemicals like CFCs has endangered the ozone layer. Since the ozone layer protects against the ultraviolet radiation from the Sun, this could damage the environment.
- The waste we generate may be biodegradable or non-biodegradable.
- The disposal of the waste we generate is causing serious environmental problems.

E X E R C I S E S

1. Which of the following groups contain only biodegradable items?
 - (a) Grass, flowers and leather
 - (b) Grass, wood and plastic
 - (c) Fruit-peels, cake and lime-juice
 - (d) Cake, wood and grass
2. Which of the following constitute a food-chain?
 - (a) Grass, wheat and mango
 - (b) Grass, goat and human

- (c) Goat, cow and elephant
 - (d) Grass, fish and goat
3. Which of the following are environment-friendly practices?
 - (a) Carrying cloth-bags to put purchases in while shopping
 - (b) Switching off unnecessary lights and fans
 - (c) Walking to school instead of getting your mother to drop you on her scooter
 - (d) All of the above
 4. What will happen if we kill all the organisms in one trophic level?
 5. Will the impact of removing all the organisms in a trophic level be different for different trophic levels? Can the organisms of any trophic level be removed without causing any damage to the ecosystem?
 6. What is biological magnification? Will the levels of this magnification be different at different levels of the ecosystem?
 7. What are the problems caused by the non-biodegradable wastes that we generate?
 8. If all the waste we generate is biodegradable, will this have no impact on the environment?
 9. Why is damage to the ozone layer a cause for concern? What steps are being taken to limit this damage?



1064CH16



CHAPTER 16

Sustainable Management of Natural Resources

'Living in harmony with nature' is not new to us. Sustainable living has always been an integral part of India's tradition and culture. It has been integrated with our long-lasting traditions and practices, customs, art and crafts, festivals, food, beliefs, rituals and folklore. Ingrained within us is the philosophy that 'entire natural world be in harmony' which is reflected in the famous phrase in Sanskrit '*Vasudhaiv kutumbakam*' that means "the entire earth is one family". The phrase is mentioned in 'Mahaupanishad', that is probably a part of the ancient Indian text, *Atharva Veda*.

In Class IX we have already learnt about some natural resources like soil, air and water and how various components are cycled over and over again in nature. Also, we learnt in the previous chapter about the pollution of these resources because of some of our activities. In this chapter, we shall look at some of our resources and how we are using them. Maybe we should also think about how we ought to be using our resources so as to sustain them and conserve our environment. We shall be looking at our natural resources like forests, wildlife, water, coal and petroleum and see what are the issues at stake in deciding how these resources are to be managed for sustainable development along with the input from our traditional practices.

We often hear or read about environmental problems. These are often global-level problems and we feel helpless to bring any change. There are international laws and regulations, and then there are our own national laws and acts for environmental protection. There are also national and international organisations working towards protecting our environment.

Activity 16.1

- Find out about the international norms to regulate the emission of carbon dioxide.
- Have a discussion in class about how we can contribute towards meeting those norms.

Activity 16.2

- There are a number of organisations that seek to spread awareness about our environment and promote activities and attitudes that lead to the conservation of our environment and natural resources. Find out about the organisation(s) active in your neighbourhood/village/town/city.
- Find out how you can contribute towards the same cause.

Awareness about the problems caused by unthinkingly exploiting our resources has been a fairly recent phenomenon in our society. And once this awareness rises, some action is usually taken. You must have heard about the Ganga Action Plan. This multi-crore project came about in 1985 because the quality of the water in the Ganga was very poor. Coliform is a group of bacteria, found in human intestines, whose presence in water indicates contamination by disease-causing microorganisms.

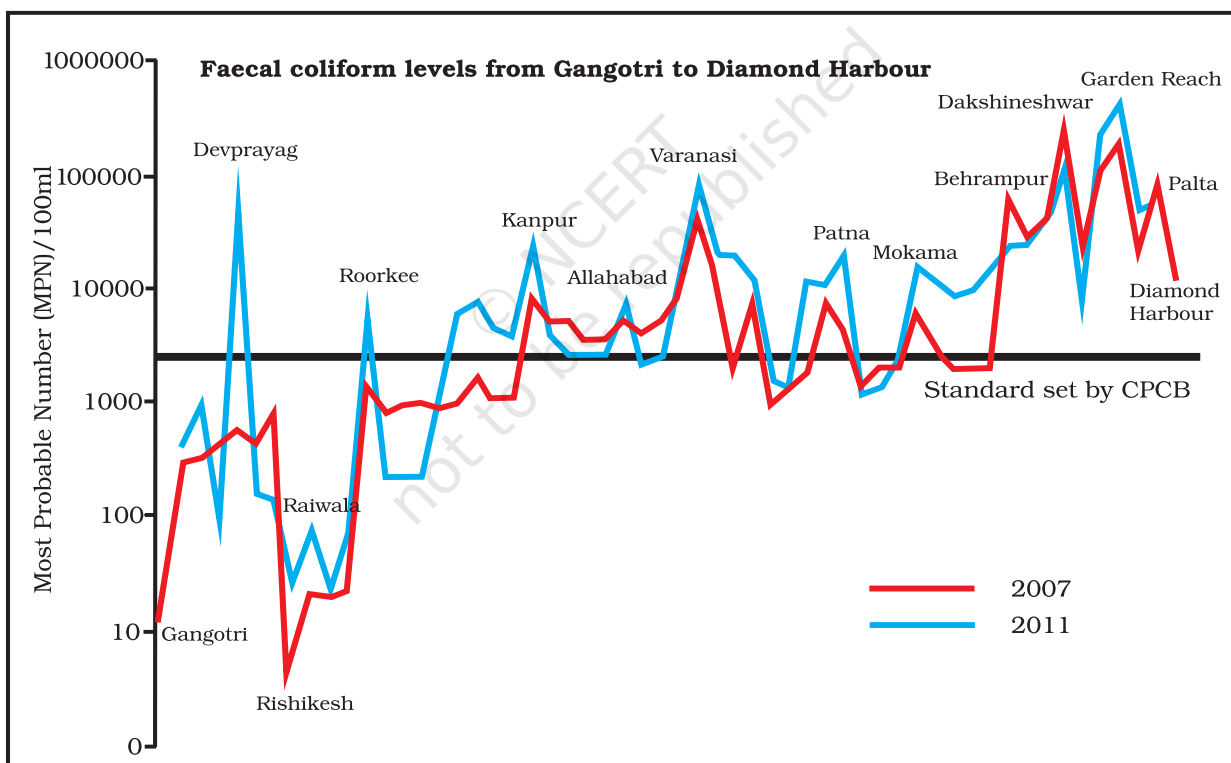

Figure 16.1 Total coliform count levels in the Ganga

Source: Central Pollution Control Board, 2012

Pollution of the Ganga

The Ganga runs its course of over 2500 km from Gangotri in the Himalayas to Ganga Sagar in the Bay of Bengal. It is being turned into a drain by more than a hundred towns and cities in Uttar Pradesh, Bihar and West Bengal that pour their garbage and excreta into it. Largely untreated sewage is dumped into the Ganges every day. In addition, think of the pollution caused by other human activities like bathing, washing of clothes and immersion of ashes or unburnt corpses. And then, industries contribute chemical effluents to the Ganga's pollution load and the toxicity kills fish in large sections of the river. Namami Gange Programme is an Integrated Conservation Mission approved as a Flagship Programme by the Union Government in June, 2014. It was launched to accomplish the twin objectives of effective abatement of pollution conservation and rejuvenation of River Ganga. The National Mission for Clean Ganga is the implementation wing set up in October, 2016.

As you can see, there are some measurable factors which are used to quantify pollution or the quality of the water that we use for various activities. Some of the pollutants are harmful even when present in very small quantities and we require sophisticated equipment to measure them. But as we learnt in Chapter 2, the pH of water is something that can easily be checked using universal indicator.

Activity 16.3

- Check the pH of the water supplied to your house using universal indicator or litmus paper.
- Also check the pH of the water in the local waterbody (pond, river, lake, stream).
- Can you say whether the water is polluted or not on the basis of your observations?

We need not feel powerless or overwhelmed by the scale of the problems because there are many things we can do to make a difference. You must have come across the five R's to save the environment: Refuse, Reduce, Reuse, Repurpose and Recycle. What do they refer to?

Refuse: This means to say No to things people offer you that you don't need. Refuse to buy products that can harm you and the environment, say No to single-use plastic carry bags.

Reduce: This means that you use less. You save electricity by switching off unnecessary lights and fans. You save water by repairing leaky taps. Do not waste food. Can you think of other things that you can reduce the usage of?

Reuse: This is actually even better than recycling because the process of recycling uses some energy. In the 'reuse' strategy, you simply use things again and again. Instead of throwing away used envelopes, you can reverse it and use it again. The plastic bottles in which you buy various food-items like jam or pickle can be used for storing things in the kitchen. What other items can we reuse?

Repurpose: This means when a product can no more be used for the original purpose, think carefully and use it for some other useful purpose. For example, cracked crockery, or cups with broken handles can be used to grow small plants and as feeding vessels for birds.

Recycle: This means that you collect plastic, paper, glass and metal items and recycle these materials to make required things instead of synthesising or extracting fresh plastic, paper, glass or metal. In order to recycle, we first need to segregate our wastes so that the material that can be recycled is not dumped along with other wastes. Does your village/town/city have a mechanism in place for recycling these materials?

Even while making everyday choices, we can make environment-friendly decisions. For doing this, we need to know more about how our choices affect the environment, these effects may be immediate or long-term or long-ranging. The concept of sustainable development encourages forms of growth that meet current basic human needs, while preserving the resources for the needs of future generations. Economic development is linked to environmental conservation. Thus sustainable development implies a change in all aspects of life. It depends upon the willingness of the people to change their perceptions of the socio-economic and environmental conditions around them, and the readiness of each individual to alter their present use of natural resources.

Activity 16.4

- Have you ever visited a town or village after a few years of absence? If so, have you noticed new roads and houses that have come up since you were there last? Where do you think the materials for making these roads and buildings have come from?
- Try and make a list of the materials and their probable sources.
- Discuss the list you have prepared with your classmates. Can you think of ways in which the use of these materials be reduced?

16.1 WHY DO WE NEED TO MANAGE OUR RESOURCES?

Not just roads and buildings, but all the things we use or consume – food, clothes, books, toys, furniture, tools and vehicles – are obtained from resources on this earth. The only thing we get from outside is energy which we receive from the Sun. Even this energy is processed by living organisms and various physical and chemical processes on the earth before we make use of it.

Why do we need to use our resources carefully? Because these are not unlimited and with the human population increasing at a tremendous rate due to improvement in health-care, the demand for all resources is increasing at an exponential rate. The management of natural resources requires a long-term perspective so that these will last for the generations to come and will not merely be exploited to the

hilt for short-term gains. This management should also ensure equitable distribution of resources so that all, and not just a handful of rich and powerful people, benefit from the development of these resources.

Another factor to be considered while we exploit these natural resources is the damage we cause to the environment while these resources are either extracted or used. For example, mining causes pollution because of the large amount of slag which is discarded for every tonne of metal extracted. Hence, sustainable natural resource management demands that we plan for the safe disposal of these wastes too.

The present day global concerns for sustainable development and conservation of natural resources are of recent origin as compared to the long tradition and culture of nature conservation in our country. Principles of conservation and sustainable management were well established in the pre-historic India.

Our ancient literature is full of such examples where values and sensitivity of humans towards nature was glorified and the principle of sustainability was established at its best.

Activity 16.5

- Observe various traditional practices for conservation of nature in your day-to-day life. Share within the peer group. Make a report and submit.

Indian texts such as Upanishads and Smritis contain many descriptions on the uses and management of forests, and highlight sustainability as an implicit theme. One hymn from *Atharva Veda* || 12.1.11 ||, later translated into English in the book *Atharva Veda — the Sanskrit Text with English Translation*, written by Devi Chand in 1997, reads:

yirayaste parvatā himavantoraṇyam te pṛthivi syonamastu
babhruṃ kṛṣṇāṃ rohiṇiṃ viśvarūpām dhruvām bhūmi pṛthivīmindraguptām
ajitohato akṣatodhyaṣṭhām pṛthivīmāham ||12.1.11|| (*Atharva Veda*)

“O Earth! Pleasant be thy hills, snow-clad mountains and forests; O numerous coloured, firm and protected earth! On this earth I stand, undefeated, unslain, unhurt.”

Another hymn that reveals utilisation and regeneration principles from *Atharva Veda* || 12.1.35 || reads:

yatte bhūme vikhanāmi kṣipraṃ tadapi rohatu
mā te marma vimṛgvari mā te hridayamarpipam ||12.1.35|| (*Atharva Veda*)

“Whatever I dig out of you, O Earth! May that have quick regeneration again; may we not damage thy vital habitat and heart.”

During the Vedic period, both productive as well as protective aspect of forest vegetation were emphasised. Agriculture emerged as a dominant economic activity during the later Vedic period. This was the time when

the concept of cultural landscape such as sacred forests and groves, sacred corridors and a variety of ethno-forestry practices were evolved that continued to the post-Vedic period, besides a wide range of ethno-forestry practices were infused with the traditions, customs and rituals and followed as a means for protection of nature and natural resource.

Q U E S T I O N S

1. What changes can you make in your habits to become more environment-friendly?
2. What would be the advantages of exploiting resources with short-term aims?
3. How would these advantages differ from the advantages of using a long-term perspective in managing our resources?
4. Why do you think that there should be equitable distribution of resources? What forces would be working against an equitable distribution of our resources?



16.2 FORESTS AND WILDLIFE

Forests are 'biodiversity hotspots'. One measure of the biodiversity of an area is the number of species found there. However, the range of different life forms (bacteria, fungi, ferns, flowering plants, nematodes, insects, birds, reptiles and so on) found, is also important. One of the main aims of conservation is to try and preserve the biodiversity we have inherited. Experiments and field studies suggest that loss of diversity may lead to loss of ecological stability.

16.2.1 Stakeholders

Activity 16.6

- Make a list of forest produce that you use.
- What do you think a person living near a forest would use?
- What do you think a person living in a forest would use?
- Discuss with your classmates how these needs differ or do not differ and the reasons for the same.

We all use various forest produce. But our dependency on forest resources varies. Some of us have access to alternatives, some do not. When we consider the conservation of forests, we need to look at the stakeholders who are –

- (i) the people who live in or around forests are dependent on forest produce for various aspects of their life (see Fig. 16.2).
- (ii) the Forest Department of the Government which owns the land and controls the resources from forests.
- (iii) the industrialists – from those who use 'tendu' leaves to make *bidis* to the ones with paper mills – who use various forest produce, but are not dependent on the forests in any one area.
- (iv) the wildlife and nature enthusiasts who want to conserve nature in its pristine form.

Let us take a look at what each of these groups needs/gets out of the forests. The local people need large quantities of firewood, small timber and thatch. Bamboo is used to make slats for huts, and baskets for collecting and storing food materials. Implements for agriculture, fishing and hunting are largely made of wood, also forests are sites for fishing and hunting. In addition to the people gathering fruits, nuts and medicines from the forests, their cattle also graze in forest areas or feed on the fodder which is collected from forests.

Do you think such use of forest resources would lead to the exhaustion of these resources? Do not forget that before the British came and took over most of our forest areas, people had been living in these forests for centuries. They had developed practices to ensure that the resources were used in a sustainable manner. After the British took control of the forests (which they exploited ruthlessly for their own purposes), these people were forced to depend on much smaller areas and forest resources started becoming over-exploited to some extent. The Forest Department in independent India took over from the British but local knowledge and local needs continued to be ignored in the management practices. Thus vast tracts of forests have been converted to monocultures of pine, teak or eucalyptus. In order to plant these trees, huge areas are first cleared of all vegetation. This destroys a large amount of biodiversity in the area. Not only this, the varied needs of the local people – leaves for fodder, herbs for medicines, fruits and nuts for food – can no longer be met from such forests. Such plantations are useful for the industries to access specific products and are an important source of revenue for the Forest Department.



Figure 16.2
A view of a forest life

Do you know how many industries are based on forest produce? A short count reveals timber, paper, lac and sports equipment.

Industries would consider the forest as merely a source of raw material for its factories. And huge interest-groups lobby the government for access to these raw materials at artificially low rates. Since these industries have a greater reach than the local people, they are not interested in the sustainability of the forest in one particular area. For example, after cutting down all the teak trees in one area, they will get

their teak from a forest farther away. They do not have any stake in ensuring that one particular area should yield an optimal amount of some produce for all generations to come. What do you think will stop the local people in behaving in a similar manner?

Activity 16.7

- Find out about any two forest produce that are the basis for an industry.
- Discuss whether this industry is sustainable in the long run. Or do we need to control our consumption of these products?

Lastly, we come to the nature and wildlife enthusiasts who are in no way dependent on the forests, but who may have considerable say in their management. The conservationists were initially taken up with large animals like lions, tigers, elephants and rhinoceros. They now recognise the need to preserve biodiversity as a whole. But shouldn't we recognise people as forming part of the forest system? There have been enough instances of local people working traditionally for conservation of forests. For example, the case of Bishnois community living in western Rajasthan on the border of the Thar desert. Conservation of forest and wildlife has been a religious tenet for them. These nature-loving people have for centuries, been conserving the flora and fauna to the extent of sacrificing their lives to protect the environment. They are living with the basic philosophy that all living things have a right to survive and share all resources. The Government of India has recently instituted an 'Amrita Devi Bishnoi National Award for Wildlife Conservation' in the memory of Amrita Devi Bishnoi, who in 1731 sacrificed her life along with 363 others for the protection of 'khejri' trees in Khejrli village near Jodhpur in Rajasthan.

Studies have shown that the prejudice against the traditional use of forest areas has no basis. Here is an example – the great Himalayan National Park contains, within its reserved area, alpine meadows which were grazed by sheep in summer. Nomadic shepherds drove their flock up from the valleys every summer. When this national park was formed, this practice was put to an end. Now it is seen that without the regular grazing by sheep the grass first grows very tall, and then falls over preventing fresh growth.

Management of protected areas by keeping the local people out or by using force cannot possibly be successful in the long run. In any case, the damage caused to forests cannot be attributed to only the local people – one cannot turn a blind eye to the deforestation caused by industrial needs or development projects like building roads or dams. The damage caused in these reserves by tourists or the arrangements made for their convenience is also to be considered.

We need to accept that human intervention has been very much a part of the forest landscape. What has to be managed in the nature and what may be the extent of this intervention? Forest resources ought to be used in a manner that is both environmentally and developmentally sound – in other words, while the environment is preserved, the benefits of the controlled exploitation go to the local people, a process in which decentralised economic growth and ecological conservation go hand in hand. The kind of economic and social development we want will ultimately determine whether the environment will be conserved or further destroyed. The environment must not be regarded as a pristine collection of plants and animals. It is a vast and complex entity that offers a range of natural resources for our use. We need to use these resources with due caution for our economic and social growth, and to meet our material aspirations.



Figure 16.3
Khejri Tree

16.2.2 Management of forest

We need to consider if the goals of all the above stakeholders with regard to the management of the forests are the same. Forest resources are often made available for industrial use at rates far below the market value while these are denied to the local people. The *Chipko Andolan* ('Hug the Trees Movement') was the result of a grassroots level effort to end the alienation of people from their forests. The movement originated from an incident in a remote village called Reni in Garhwal, high-up in the Himalayas during the early 1970s. There was a dispute between the local villagers and a logging contractor who had been allowed to fell trees in a forest close to the village. On a particular day, the contractor's workers appeared in the forest to cut the trees while the men folk were absent. Undeterred, the women of the village reached the forest quickly and clasped the tree trunks thus preventing the workers from felling the trees. Thus thwarted, the contractor had to withdraw.

Inherent in such a competition to control a natural resource is the conservation of a replenishable resource. Specifically the method of use was being called into question. The contractor would have felled the trees, destroying them forever. The communities traditionally lop the branches and pluck the leaves, allowing the resource to replenish over time. The *Chipko* movement quickly spread across communities and media, and forced the government, to whom the forest belongs, to rethink their priorities in the use of forest produce. Experience has taught people that the destruction of forests affected not just the availability of forest products, but also the quality of soil and the sources of water. Participation of the local people can indeed lead to the efficient management of forests.

An Example of People's Participation in the Management of Forests

In 1972, the West Bengal Forest Department recognised its failures in reviving the degraded *Sal* forests in the south-western districts of the state. Traditional methods of surveillance and policing had led to a 'complete alienation of the people from the administration', resulting in frequent clashes between forest officials and villagers. Forest and land related conflicts in the region were also a major factor in fuelling the militant peasant movements led by the Naxalites.

Accordingly, the Department changed its strategy, making a beginning in the Arabari forest range of Midnapore district. Here, at the insistence of a far-seeing forest officer, A.K. Banerjee, villagers were involved in the protection of 1,272 hectares of badly degraded sal forest. In return for help in protection, villagers were given employment in both silviculture and harvesting operations, 25 per cent of the final harvest, and allowed fuelwood and fodder collection on payment of a nominal fee. With the active and willing participation of the local community, the

sal forests of Arabari underwent a remarkable recovery – by 1983, a previously worthless forest was valued Rs 12.5 crores.

Activity 16.8

- Debate the damage caused to forests by the following —
 - (a) Building rest houses for tourists in national parks.
 - (b) Grazing domestic animals in national parks.
 - (c) Tourists throwing plastic bottles/covers and other litter in national parks.

Q U E S T I O N S

1. Why should we conserve forests and wildlife?
2. Suggest some approaches towards the conservation of forests.



16.3 WATER FOR ALL

Activity 16.9

- Villages suffering from chronic water shortage surround a water theme park in Maharashtra. Debate whether this is the optimum use of the available water.

Water is a basic necessity for all terrestrial forms of life. We studied in Class IX about the importance of water as a resource, the water cycle and how human intervention pollutes waterbodies. However, human intervention also changes the availability of water in various regions.

Activity 16.10

- Study the rainfall patterns in India from an atlas.
- Identify the regions where water is abundant and the regions of water scarcity.

After the above activity, would you be very surprised to learn that regions of water scarcity are closely correlated to the regions of acute poverty?

A study of rainfall patterns does not reveal the whole truth behind the water availability in various regions in India. Rains in India are largely due to the monsoons. This means that most of the rain falls in a few months of the year. Despite nature's monsoon bounty, failure to sustain water availability underground has resulted largely from the loss of vegetation cover, diversion for high water demanding crops, and pollution from industrial effluents and urban wastes. Irrigation methods like dams, tanks and canals have been used in various parts of India since ancient times. These were generally local interventions managed by local people and assured that the basic minimum requirements for both agriculture and daily needs were met throughout the year. The use of this stored

water was strictly regulated and the optimum cropping patterns based on the water availability were arrived at on the basis of decades/centuries of experience, the maintenance of these irrigation systems was also a local affair.

The arrival of the British changed these systems as it changed many other things. The conception of large scale projects – large dams and canals traversing large distances were first conceived and implemented by the British and carried on with no less gusto by our newly formed independent government. These mega-projects led to the neglect of the local irrigation methods, and the government also increasingly took over the administration of these systems leading to the loss of control over the local water sources by the local people.

Kulhs in Himachal Pradesh

Parts of Himachal Pradesh had evolved a local system of canal irrigation called *kulhs* over four hundred years ago. The water flowing in the streams was diverted into man-made channels which took this water to numerous villages down the hillside. The management of the water flowing in these *kulhs* was by common agreement among all the villages. Interestingly, during the planting season, water was first used by the village farthest away from the source of the *kulh*, then by villages progressively higher up. These *kulhs* were managed by two or three people who were paid by the villagers. In addition to irrigation, water from these *kulhs* also percolated into the soil and fed springs at various points. After the *kulhs* were taken over by the Irrigation Department, most of them became defunct and there is no amicable sharing of water as before.

More to Know!

16.3.1 Dams

Why do we seek to build dams? Large dams can ensure the storage of adequate water not just for irrigation, but also for generating electricity, as discussed in the previous chapter. Canal systems leading from these dams can transfer large amounts of water over great distances. For example, the Indira Gandhi Canal has brought greenery to considerable areas of Rajasthan. However, mismanagement of the water has largely led to the benefits being cornered by a few people. There is no equitable distribution of water, thus people close to the source grow water intensive crops like sugarcane and rice while people farther downstream do not get any water. The woes of these people who have been promised benefits which never arrived are added to the discontentment among the people who have been displaced by the building of the dam and its canal network.

In the previous chapter, we mentioned the reasons for opposition to the construction of large dams, such as the Tehri Dam on the river Ganga. You must have read about the protests by the *Narmada Bachao Andolan* ('Save the Narmada Movement') about raising the height of the Sardar Sarovar Dam on the river Narmada. Criticisms about large dams address three problems in particular –

- (i) Social problems because they displace large number of peasants and tribals without adequate compensation or rehabilitation,
- (ii) Economic problems because they swallow up huge amounts of public money without the generation of proportionate benefits,

- (iii) Environmental problems because they contribute enormously to deforestation and the loss of biological diversity.

The people who have been displaced by various development projects are largely poor tribals who do not get any benefits from these projects and are alienated from their lands and forests without adequate compensation. The oustees of the Tawa Dam built in the 1970s are still fighting for the benefits they were promised.

16.3.2 Water Harvesting

Watershed management emphasises scientific soil and water conservation in order to increase the biomass production. The aim is to develop primary resources of land and water, to produce secondary resources of plants and animals for use in a manner which will not cause ecological imbalance. Watershed management not only increases the production and income of the watershed community, but also mitigates droughts and floods and increases the life of the downstream dam and reservoirs. Various organisations have been working on rejuvenating ancient systems of water harvesting as an alternative to the 'mega-projects' like dams. These communities have used hundreds of indigenous water saving methods to capture every trickle of water that had fallen on their land; dug small pits and lakes, put in place simple watershed systems, built small earthen dams, constructed dykes, sand and limestone reservoirs, set up rooftop water-collecting units. This has recharged groundwater levels and even brought rivers back to life.

Water harvesting is an age-old concept in India. *Khadins*, tanks and *nadis* in Rajasthan, *bandharas* and *tals* in Maharashtra, *bundhis* in Madhya Pradesh and Uttar Pradesh, *ahars* and *pynes* in Bihar, *kulhs* in Himachal Pradesh, ponds in the Kandi belt of Jammu region, and *eris* (tanks) in Tamil Nadu, *surangams* in Kerala, and *kattas* in Karnataka are some of the ancient water harvesting, including water conveyance, structures still in use today (see Fig. 16.4 for an example). Water harvesting techniques are highly locale specific and the benefits are also localised. Giving people control over their local water resources ensures that mismanagement and over-exploitation of these resources is reduced/removed.

In largely level terrain, the water harvesting structures are mainly crescent shaped earthen embankments or low, straight concrete-and-rubble "check dams" built across seasonally flooded gullies. Monsoon rains fill ponds behind the structures. Only the largest structures hold water year round; most dry up six months or less after the monsoons. Their main purpose, however, is not to hold surface water but to recharge the ground water beneath. The advantages of water stored in the ground

A traditional technology is helping India's "waterman" save thousands of parched villages and transform the lives of thousands of villagers in one of India's most arid regions. In "two decades of efforts of Dr. Rajendra Singh, 8,600 *johads* and other structures to collect water have been built in Rajasthan," and "Water had been brought back to a 1,000 villages across the state." In 2015, he won the Stockholm Water Prize. It is the most prestigious award which honours a person who contributes to the conservation and protection of water resources for the well-being of the planet and its inhabitants.

are many. It does not evaporate, but spreads out to recharge wells and provides moisture for vegetation over a wide area. In addition, it does not provide breeding grounds for mosquitoes like stagnant water collected in ponds or artificial lakes. The groundwater is also relatively protected from contamination by human and animal waste.

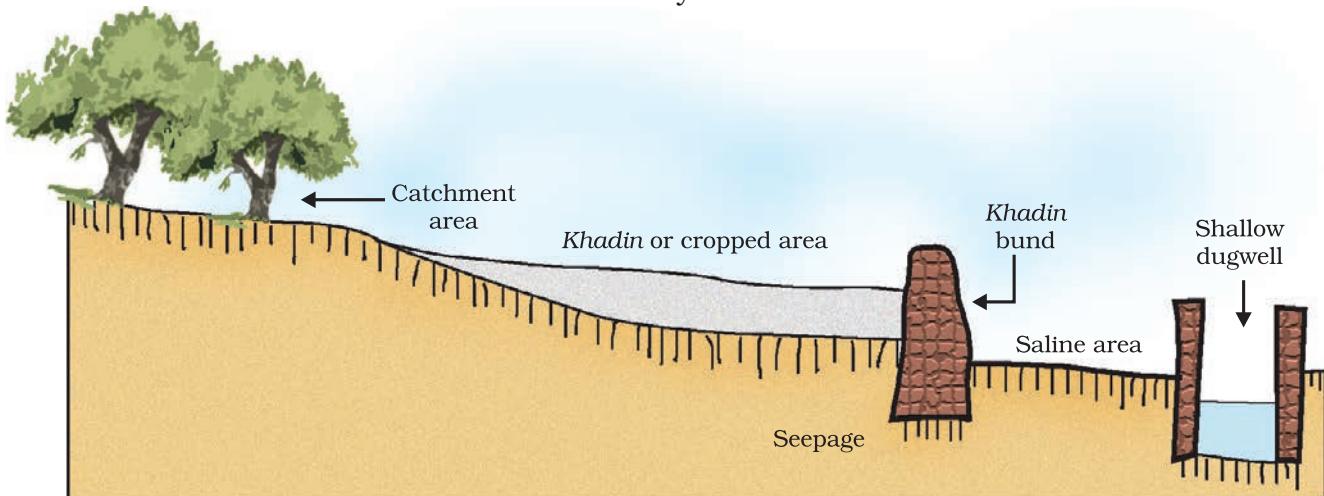

Figure 16.4 Traditional water harvesting system — an ideal setting of the khadin system

Q U E S T I O N S

1. Find out about the traditional systems of water harvesting/management in your region.
2. Compare the above system with the probable systems in hilly/mountainous areas or plains or plateau regions.
3. Find out the source of water in your region/locality. Is water from this source available to all people living in that area?



16.4 COAL AND PETROLEUM

We have seen some of the issues involved in the conservation and sustainable use of resources like forests, wildlife and water. These can meet our needs perpetually if we were to use them in a sustainable manner. Now we come to yet another important resource – fossil fuels, that is, coal and petroleum, which are important sources of energy for us. Since the industrial revolution, we have been using increasing amounts of energy to meet our basic needs and for the manufacture of a large number of goods upon which our lives depend. These energy needs have been largely met by the reserves of coal and petroleum.

The management of these energy sources involves slightly different perspectives from those resources discussed earlier. Coal and petroleum were formed from the degradation of bio-mass millions of years ago and hence these are resources that will be exhausted in the future no matter how carefully we use them. And then we would need to look for alternative sources of energy. Various estimates exist as to how long these resources

will last if the present rate of usage continues. It is estimated that our known petroleum resources will last us for about forty years and the coal resources will last for another two hundred years.

But looking at other sources of energy is not the only consideration when we look at the consumption of coal and petroleum. Since coal and petroleum have been formed from bio-mass, in addition to carbon, these contain hydrogen, nitrogen and sulphur. When these are burnt, the products are carbon dioxide, water, oxides of nitrogen and oxides of sulphur. When combustion takes place in insufficient air (oxygen), then carbon monoxide is formed instead of carbon dioxide. Of these products, the oxides of sulphur and nitrogen and carbon monoxide are poisonous at high concentrations and carbon dioxide is a greenhouse gas. Another way of looking at coal and petroleum is that they are huge reservoirs of carbon and if all of this carbon is converted to carbon dioxide, then the amount of carbon dioxide in the atmosphere is going to increase, leading to intense global warming. Thus, we need to use these resources judiciously.

Activity 16.11

- Coal is used in thermal power stations and petroleum products like petrol and diesel are used in means of transport like motor vehicles, ships and aeroplanes. We cannot really imagine life without a number of electrical appliances and constant use of transportation. So can you think of ways in which our consumption of coal and petroleum products be reduced?

Some simple choices can make a difference in our energy consumption patterns. Think over the relative advantages, disadvantages and environment-friendliness of the following –

- (i) Taking a bus, using your personal vehicle or walking/cycling.
- (ii) Using LED bulbs or fluorescent tubes in your homes.
- (iii) Using the lift or taking the stairs.
- (iv) Wearing an extra sweater or using a heating device (heater or 'sigrī') on cold days.

The management of coal and petroleum also addresses the efficiency of our machines. Fuel is most commonly used in internal combustion engines for transportation and recent research in this field concentrates on ensuring complete combustion in these engines in order to increase efficiency and also reduce air pollution.

Activity 16.12

- You must have heard of the Euro I and Euro II norms for emission from vehicles. Find out how these norms work towards reducing air pollution.

16.5 AN OVERVIEW OF NATURAL RESOURCE MANAGEMENT

Sustainable management of natural resources is a difficult task. In addressing this issue, we need to keep an open mind with regard to the interests of various stakeholders. We need to accept that people will act with their own best interests as the priority. But the realisation that such selfish goals will lead to misery for a large number of people and a total destruction of our environment is slowly growing. Going beyond laws, rules and regulations, we need to tailor our requirements, individually and collectively, so that the benefits of development reach everyone now and for all generations to come.

What you have learnt

- Our resources like forests, wildlife, water, coal and petroleum need to be used in a sustainable manner.
- We can reduce pressure on the environment by sincerely applying the maxim of 'Refuse, Reduce, Reuse, Repurpose and Recycle' in our lives.
- Management of forest resources has to take into account the interests of various stakeholders.
- The harnessing of water resources by building dams has social, economic and environmental implications. Alternatives to large dams exist. These are locale-specific and may be developed so as to give local people control over their local resources.
- The fossil fuels, coal and petroleum, will ultimately be exhausted. Because of this and because their combustion pollutes our environment, we need to use these resources judiciously.

EXERCISES

1. What changes would you suggest in your home in order to be environment-friendly?
2. Can you suggest some changes in your school which would make it environment-friendly?
3. We saw in this chapter that there are four main stakeholders when it comes to forests and wildlife. Which among these should have the authority to decide the management of forest produce? Why do you think so?
4. How can you as an individual contribute or make a difference to the management of (a) forests and wildlife, (b) water resources and (c) coal and petroleum?
5. What can you as an individual do to reduce your consumption of the various natural resources?
6. List five things you have done over the last one week to —
 - (a) conserve our natural resources.
 - (b) increase the pressure on our natural resources.
7. On the basis of the issues raised in this chapter, what changes would you incorporate in your lifestyle in a move towards a sustainable use of our resources?

Answers

Chapter 1

1. (i) 2. (d) 3. (a)

Chapter 2

1. (d) 2. (b) 3. (d) 4. (c)

Chapter 3

1. (d) 2. (c) 3. (a) 4. (c)

Chapter 4

1. (b) 2. (c) 3. (b)

Chapter 5

1. (c) 2. (b)

Chapter 6

1. (c) 2. (a) 3. (d) 4. (b)

Chapter 7

1. (d) 2. (b) 3. (d)

Chapter 8

1. (b) 2. (c) 3. (d)

Chapter 9

1. (c) 2. (d) 3. (a)

Chapter 10

1. (d) 2. (d) 3. (b)
4. (a) 5. (d) 6. (c)

7. Distance less than 15 cm; virtual; Enlarged.

9. Yes

10. 16.7 cm from the lens on the other side; 3.3 cm, reduced; real, inverted.

11. 30 cm

12. 6.0 cm, behind the mirror; virtual, erect

13. $m = 1$ indicates that image formed by a plane mirror is of the same size as the object. Further, the positive sign of m indicates that the image is virtual and erect.

14. 8.6 cm, behind the mirror; virtual, erect; 2.2 cm, reduced.

15. 54 cm on the object side; 14 cm, magnified; real, inverted.

16. -0.50 m; concave lens

17. $+0.67$ m; converging lens

Chapter 11

- (b)
- (d)
- (c)
- (c)
- (i) -0.18 m; (ii) $+0.67$ m
- Concave lens; -1.25 D
- Convex lens; $+3.0$ D

Chapter 12

- (d)
- (b)
- (d)
- (c)
- Parallel
- 122.7 m; $\frac{1}{4}$ times
- 3.33Ω
- $4.8 \text{ k}\Omega$
- 0.67 A
- 4 resistors
- 110 bulbs
- 9.2 A, 4.6 A, 18.3 A
- (i) 8 W; (ii) 8 W
- 0.73 A
- 250 W TV set in 1 hour
- 120 W
- (b) High resistivity of alloys
(d) inversely.

Chapter 13

- (d)
- (c)
- (a)
- (d)
- (c)
- (a) False (b) True (c) True (d) False
- vertically downwards
- (i) The needle will move momentarily in one direction
(ii) The needle will move momentarily but in opposite direction to (i)
(iii) No deflection in the needle would be observed.
- (a) Right-hand thumb rule, (b) Fleming's left-hand rule, (c) Fleming's right-hand rule.

Chapter 14

- (b)
- (c)
- (c)

Chapter 15

- (a), (c), (d)
- (b)
- (d)